



Dräger-Tubes & CMS-Handbook 17th edition

Soil, Water, and Air Investigations as well as
Technical Gas Analysis

Dräger-Tubes & CMS Handbook

Soil, Water, and Air Investigations as well as
Technical Gas Analysis

17th Edition

Dräger Safety AG & Co. KGaA,
Lübeck, 2015

This handbook is intended to be a reference source for the user. The information has been compiled to the best of our knowledge from relevant reference sources. However, the Dräger organisation is not responsible for any consequence or accident which may occur as the result of misuse or, misinterpretation of the information contained in this handbook.

The instructions for use may not always correspond to the data given in this book. For a full understanding of the performance characteristics of the measurement devices and for the use of the Dräger products only the instructions for use enclosed with the product shall apply. The user should carefully read the instructions for use prior to the use of the measurement devices.

Furthermore, the Dräger organization has attempted to provide current factual information regarding industrial hygiene standards and occupational exposure levels, but inasmuch as these standards and levels are being revised periodically, the user should consult current local, state and federal regulations.

Technical data are subject to modifications.

Publisher: Dräger Safety AG & Co KGaA

Dräger-Tube/CMS Handbook: Handbook for short term measurements
in soil, water and air investigations as well as technical gas analysis.

Lübeck, 2015

ISBN 3-926762-06-3

© 2015 Dräger Safety AG & Co. KGaA

Revalstrasse 1 | 23560 Luebeck | Germany

Printed in Germany

Editorial Date: March 2015

ISBN 3-926762-06-3

Preface

Since the last edition, a range of new developments, improvements and modifications have affected Dräger-Tubes measurement technology. The data section on the individual Dräger-Tubes and systems has been expanded and updated. Many of the pictures of the Dräger-Tubes that are described have been recreated, as it was possible to improve the color depth and color contrast of different tubes by using an optimized production method.

The design of the present 17th Edition retains the layout and structure of the previous edition.

Lübeck, March 2015

Dräger Safety AG & Co. KGaA

Table of Contents

1. General	8
1.1 Introduction to Gas Measuring	8
1.2 Concentration, Specifications, and Conversions	11
1.3 Water Vapor and Humidity	13
1.4 Information System Dräger VOICE	16
2. Dräger-Tubes and Applications	17
2.1 Dräger-Tube Measurement	17
2.2 Chemical Basics – Reaction Mechanisms	22
2.3 Dräger-Tube Measurement System	25
2.4 Dräger-Tubes for Short-Term Measurements	32
2.5 Evaluation of Dräger-Tubes	35
2.6 Hot Air Probe	37
2.7 Extension Hose	38
2.8 Determination of Carbon Monoxide Content in Exhaled Air	38
2.9 Investigation of Compressed Air, Medical Gases, and Carbon Dioxide	39
2.10 Proposed Strategy for Determining Gas Hazards	43
2.11 Measurement of Fumigants	49
2.12 Determination of Volatile Contaminants in Liquid Samples	52
2.13 Detection of Air Flows	54
2.14 Dräger-Measurement-Systems for Long-Term Measurements	55
2.15 Expiration Date, Storage, and Disposal of Dräger-Tubes	56
2.16 Dräger-Sampling-Systems	57
2.17 Measurement of Aldehydes and Isocyanates at the Workplace	60
2.18 Quality Control for Dräger-Tubes	61
3. Dräger-Chip-Measurement-System	63
3.1 The Philosophy of the Chip-Measurement-System Dräger CMS	63
3.2 The Components of the Dräger CMS	64
3.3 The Chip	65
3.4 The Analyzer	66
3.5 The Measurement	67
3.6 The Data Recorder	69
3.7 Measuring with the Remote System	69
3.8 Validation of Third Parties	70
3.9 Technical Data Dräger CMS	72
3.10 Approvals	73

4. Overview of the Dräger-Tubes and Chip-Measurement-Systems	74
4.1 Dräger-Tube Pumps and Systems	74
4.2 Dräger-Tubes for Short-Term Measurements	75
4.3 Dräger-Tubes for Measurements in Liquid Samples	82
4.4 Dräger-Diffusion-Tubes with Direct Indication	84
4.5 Dräger-Sampling-Tubes and Systems	85
4.6 Overview of Substances for Measurement with Dräger-Sampling-Tubes and Systems	86
4.7 Dräger-Chips	94
5. Data and Tables	96
5.1 Dräger-Tube Measurement System	96
5.1.1 Explanation to the Data about Dräger-Tubes	96
5.1.2 Data about Dräger-Tubes for Short-Term Measurements	99
5.1.3 Data about Dräger Simultaneous Test Set	273
5.1.4 Data about Dräger-Tubes for Military Applications	281
5.1.5 Data about Dräger-Tubes used with Dräger Aerotest	293
5.1.6 Measuring Instructions of Contaminants in Liquids	307
5.1.7 Data about Direct Indicating Dräger Diffusion Tubes	351
5.1.8 Data about Dräger Sampling Tubes and Systems	367
5.2 Dräger- Chip-Measurement-System	380
5.2.1 Explanation to the Data about Dräger-Chips	380
5.2.2 Data about Dräger-Chips for Short-Term Measurements	381
5.3 Physical, Chemical, and Toxicological Data for selected Substances	410
5.3.1 Explanation to the Physical, Chemical, and Toxicological Data	410
5.3.2 Table of Physical, Chemical, and Toxicological Data for selected Substances	413
6. Directory of Synonyms	446

1. General

1.1 Introduction to Gas Measuring

Natural, ambient air is chemically a gas mixture that consists of 78 % nitrogen, 21 % oxygen 0.03% carbon dioxide as well as argon, helium and other rare gases in trace concentrations. In addition there is water vapor, e. g. humidity. If the concentrations of the components change, or a foreign gas is added, we no longer have natural air. When these changes occur, the potential for adverse health effects exist.

The spectrum of other so-called air components can be extremely broad. It can range from the pleasant fragrance of a good perfume to the overpowering stench of hydrogen sulfide. Likewise, the hazard of each "air pollutant" varies considerably. The type of substance, its concentration and duration of occurrence, as well as probable synergistic effects with certain gas compounds must all be considered. In addition, there are many air pollutants which cannot be perceived by human senses because they are colorless and odorless (e. g. carbon monoxide).

If the composition of the natural air changes in any way, it should be tested, to determine the substance which caused this change. Even substances with distinctive odors cannot be reliably assessed with the aid of the olfactory nerve in the nose. The olfactory nerve can become desensitized after a certain period of time or repeated exposure, making it impossible to smell even immediately dangerous concentrations. After a few hours we do not even perceive the pleasant fragrance of our own perfume and high concentrations of hydrogen sulfide escape from the sense of smell even after a very short while.

Subjectively, one persons sense of smell may be more sensitive to certain air pollutants than others. In many cases substances are noticed in very low concentrations which, even after a long-term exposure do not necessarily cause adverse health effects. In general the sense of smell is sufficient in determining the presence of air pollutants, but the need exists for an objective gas analysis method. Gas measurement serves as a technical aid and an assessment of the concentration is only possible with a gas measurement device. To determine the hazard potential of a gas it is necessary to measure its concentration and to consider the duration of exposure and other parameters such as the type of work being performed.

If only the concentration of an air pollutant is known it is difficult to evaluate the degree of the hazard. For Example, there is a degree of uncertainty regarding the health effects of cigarette smoking. The synergistic effect of the more than 800 single substances in cigarette smoke and the physiological condition of the smoker are all factors in determining the toxicological influence to the individual.

An important prerequisite to determining the potential of any gaseous air pollutants is the determination of the concentration with a suitable gas measurement device. The kind of device to be used depends on which gases have to be measured and how often. Much to the dismay of both the user and the manufacturer, there is no universal instrument which measures all gases or vapors. The variety of substances is too wide for a single technique to measure all possible air pollutants. The more chemically complex a substance is, the more complex the gas measurement technique.

It may be that more than one measurement device or measurement method may be employed, each based on different operational principles. The instrumentation industry offers various devices for this purpose which can be used, individually or in combination on the measurement task:

- flame ionization detectors
- photo ionization detectors
- gas chromatographs
- infrared spectrometers
- UV-VIS photometers
- warning devices for explosion hazards
- Dräger-Tubes
- Dräger Chip-Measurement-System
- laboratory analysis in conjunction with sampling tubes or gas wash bottles (impinger)
- mass spectrometers
- substance selective instruments with e. g. electrochemical sensors

The choice of which monitor or measurement method to use depends upon the objective. The user must evaluate the situation and determine which substances to measure, how often, etc. Each of the above mentioned devices and methods have advantages and limitations. There is no universal monitor for all possible scenarios. For the selection of a suitable measuring device and to support the user in solving measurement problems, Dräger Safety AG & Co. KGaA offers competent know-how and technical assistance. The customer / employer should carefully train the user / employee on the use of their measurement device. Any use of the measurement device without receiving prior comprehensive training can be permitted by the customer / employer to the user / employees, at the customer / employees own risk.



ST-1639-2007

Photo and flame ionization detectors are distinguished by short Dräger X-am 5000

response periods but they do not offer substance selectivity. Gas chromatographs, infrared and UV-VIS photometers are very versatile but on the other hand they are comparatively expensive and require a specialist to calibrate the devices and interpret the readings correctly. Warning devices for explosion hazards like the Dräger X-am 5000 are equipped with catalytical sensors to determine explosion levels of combustible gases and vapors. They are not designed to measure lower concentrations and thus are not suitable for this task.



1-394-90

Dräger-Tubes

Dräger-Tubes with direct reading colorimetric indication have many applications. Approximately 500 different substances can be measured with Dräger-Tubes.

Limited selectivity and the fact that Dräger-Tubes are usually capable of only being used a once may present a disadvantage. If repeated measurements of the same substance are to be performed daily, a measurement device like the Dräger Pac 7000 CO with its electrochemical sensor for the measurement of carbon monoxide is more economic than Dräger-Tubes.



ST-967/2004

Laboratory Analysis in the Dräger Analysis Service

When complex mixtures (e. g. solvent mixtures), are present, usually only a laboratory analysis will suffice. The prerequisite is that the contaminated air is trapped in a sorbent sampling tube like silica gel or activated charcoal.

After collecting the sample, analysis is performed in the laboratory with gas chromatographic methods, or sometimes by the combination of gas chromatography / mass spectroscopy. Laboratory procedures of this kind offer particularly high

selectivity, but the analysis devices are very expensive, requiring high maintenance costs and operation by specialists.

Regardless of the gas measurement device or what analysis procedure is used, it is essential that the contaminant of interest be identifiable and measurable. Apart from a few exceptions in process monitoring, it is very unlikely that concentrations of other substances can be determined by subtracting the concentration of the gas which can be identified. For example, if the oxygen concentration is below the 17 Vol. % limit, it cannot be said which substance has displaced the oxygen without further investigation. In the case of very high carbon dioxide concentrations there is the danger of suffocation; likewise if there is a leak in a gas pipeline the presence of methane poses an explosion hazard. Other

contaminants present in the ppm or ppb range would not influence the oxygen measurement enough to alert anyone to a potential hazard. Since many of the occupational exposure limits are in the range of 1 ppm or lower, the measurement by difference technique is typically inadequate.

Before each measurement an assessment of the situation should be made as to what contaminants are in question, at what locations, at what times, and so forth, according to established safety procedures. Monitoring according to established safety guidelines will help ensure safety in the workplace and effective use of monitoring equipment.

1.2 Concentration, Specifications, and Conversions

Concentrations are given as the content of a substance in a reference substance. For the measurement of contaminants in air, a concentration is used for the amount of the substance compared to the air. An appropriate engineering unit is chosen, to give simple, handy figures for indicating a concentration.

High concentrations are generally given in volume percent (Vol.-%), i.e. 1 part of a substance in 100 parts of air. Air consists of 21 Vol.-% oxygen. (i.e. 100 parts of air contain 21 parts of oxygen).

In smaller concentrations the engineering unit ppm = parts per million (mL/m^3) is used. The concentration ppm means 1 part of a substance in 1 million parts of air, ppb refers to 1 part of a substance in 1 billion parts of air.

The conversion of very small concentration units to Vol.-% is as follows:

$$1 \text{ Vol.-%} = 10,000 \text{ ppm} = 10,000,000 \text{ ppb}$$

In addition to gaseous components the air also contains solid particles or liquid droplets, called aerosols. Since an indication in volume percent is not very useful due to the small size of the droplets or particles, the concentration of the aerosols is given in mg/m^3 .

		Vol.-%	ppm	ppb
Vol.-% =	$\frac{10 \text{ L}/\text{m}^3}{1 \text{ cL}/\text{L}}$	1	10^4	10^7
ppm =	$\frac{\text{mL}/\text{m}^3}{\mu\text{L}/\text{L}}$	10^{-4}	1	10^3
ppb =	$\frac{\mu\text{L}/\text{m}^3}{\text{nL}/\text{L}}$	10^{-7}	10^{-3}	1

		g/L	mg/L	mg/m^3
g/L =	$\frac{10 \text{ L}/\text{m}^3}{1 \text{ cL}/\text{L}}$	1	10^3	10^6
mg/L =	$\frac{\text{mL}/\text{m}^3}{\mu\text{L}/\text{L}}$	10^{-3}	1	10^3
$\text{mg}/\text{m}^3 =$	$\frac{\mu\text{L}/\text{m}^3}{\text{nL}/\text{L}}$	10^{-6}	10^{-3}	1

Since each volume is related to a corresponding mass, the volume concentrations of gaseous substances can be converted into mass per unit volumes and vice versa. These conversions must be done at a specified temperature and pressure since the gas density is a function of temperature and pressure. For measurements at work places, the reference parameters are 20 °C and 1013 hPa.

Conversion from mg/m³ to ppm

$$c \text{ [ppm]} = \frac{\text{mole volume}}{\text{molar mass}} \cdot c$$

The mole volume of any gas is 24.1 L/mole at 20 °C and 1013 hPa, the molar mass (molecular weight) is gas specific.

Example for acetone:

mole volume	24.1	L/mole
molar mass	58	g/mole
assumed concentration	876	mg/m ³

$$c \text{ [ppm]} = \frac{24.1}{58} \cdot 876$$

Concentration in ppm: $c = 364 \text{ ppm or mL/m}^3$.

Conversion from ppm to mg/m³

$$c \text{ [mg/m}^3\text{]} = \frac{\text{molar mass}}{\text{mole volume}} \cdot c$$

with the assumed concentration of 364 ppm it is:

$$c \text{ [mg/m}^3\text{]} = \frac{58}{24.1} \cdot 364$$

Concentration in mg/m³ : $c = 876 \text{ mg/m}^3$.

1.3 Water Vapor and Humidity

Water vapor in the atmosphere is commonly called humidity. There are many sources for it, after all the surface of the earth consists of two thirds water. Humans also "produce" water vapor as a metabolic product with each breath that is exhaled.

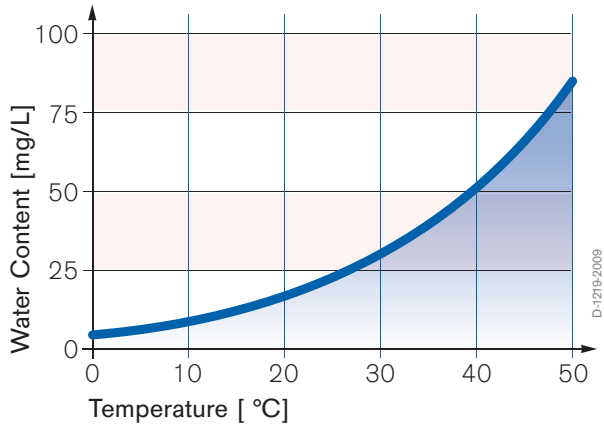

The maximum water vapor content of the air depends on temperature, i. e. the figures of relative humidity are always to be considered in reference to temperature. To convert relative humidity into absolute humidity as a function of temperature, the above diagram or the following formula can be used. Using a pocket calculator a conversion can be done:

$$Y = 3.84 \cdot 10^{-6} \cdot \vartheta^4 + 2.93 \cdot 10^{-5} \cdot \vartheta^3 + 0.014 \cdot \vartheta^2 + 0.29 \cdot \vartheta + 4.98$$

With y = maximum absolute humidity in mg H₂O / L and ϑ = temperature in °C. This formula is valid for the temperature range of 0 to 100 °C.

Example: The absolute humidity at $t = 25$ °C is needed. Using the formula the result is $y = 22.94$ mg H₂O / L. The result indicates that at 25 °C the maximum absolute humidity is 22.94 mg/L; that corresponds to a relative humidity of 100 % at the same temperature.

Similarly, every other absolute humidity at this temperature can be calculated, e. g. 50 % relative humidity at 25 °C equals 11.47 mg H₂O / L etc. If the relative humidity and the corresponding temperature are known, the absolute humidity can be calculated using the above formula.

A general statement about the effect of humidity on detector tube indications cannot be made. Some tubes, like hydrogen sulfide, need only a minimum amount of water vapor since the indicating reaction of this tube is an ion reaction. Also, because of the extraordinarily low solubility of metal sulfides, the upper limit of the humidity is not important with these tubes. However, with other types of tubes the reaction system can possibly be diluted with high humidity. Therefore, the limits of the humidity given for the respective detector tubes must be observed to prevent erroneous measurements.

As a general rule the upper and lower humidity limits are given in the instructions for use and in this handbook. When in doubt, measure the humidity using a water vapor Dräger-Tube.

1.4 Information System Dräger VOICE

The Dräger VOICE database provides up-to-date information about more than 1,600 hazardous substances and recommendations for the products offered by Dräger to measure these hazardous substances and to protect oneself against them. It also includes instructions on how to handle and use the products recommended. The program starts with a search template that searches the requested hazardous substance by entering a chemical name, CAS, EINECS or UN number, the chemical formula or one of the substance's synonyms. Detailed continuously updated information about the substance selected can be retrieved such as:

- German and international limit values
- various physical-chemical properties such as molar mass, density, melting point, boiling point and explosion limits in air
- markings such as danger symbols, Kemlerzahl, R & S safety standards, regulatory and safety data, and danger notices
- synonyms

The Dräger-Tubes that are recommended for detection of the selected substance are categorised in short-term and long-term tubes and Chip-Measurement-System. Usually the following information about the products is available:

- picture and enlarged view
- order number
- list of measuring ranges for different measuring instructions and cross sensitivities
- related products

The Dräger VOICE database is available on the internet directly via www.draeger.com/voice

2. Dräger-Tubes and Applications

2.1 Dräger-Tube Measurement

Today, detector tubes are one of the classical measurement techniques of gas analysis. The first detector tube patent appeared in America in 1919. Two Americans, A. B. Lamb and C. R. Hoover, impregnated pumice with a mixture of iodine pentoxide and sulfuric acid. This preparation, which they put in a vial, became the first chemical sensor for measuring or rather detecting carbon monoxide. Before this early detector tube, canaries were used as "sensors" in coal mining.

This first detector tube was only used for qualitative detection of the presence of carbon monoxide, quantitative measurement was not yet possible. Today the Dräger-Tubes provide quantitative results with a high degree of accuracy and selectivity. Since the development of the first Dräger-Tube, more than 75 years ago, Dräger has expanded the product line and Dräger-Tubes belong to the traditional products of Dräger.

In comparison with the first detector tube patent, the basic shape and structure of a tube may appear not to have changed; however, closer inspection reveals the contents have changed dramatically. What is a Dräger-Tube? Simplistically, it is a vial which contains a chemical preparation that reacts with the measured substance by changing color. To achieve the normal shelf life of 2 years the tube tips are fused at both ends.

Thus, the vial provides an inert package for the reagent system. Most of the Dräger-Tubes are scale tubes and it should be emphasized that the length-of-stain discoloration is an indication of the concentration of the measured substance.

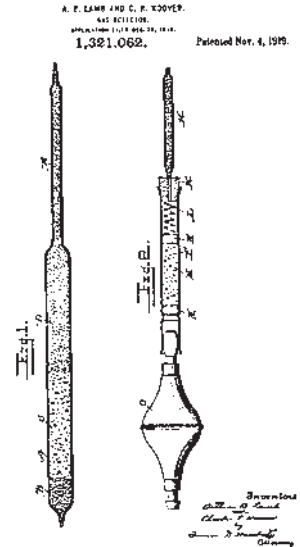

Patent drawing by Lamb and Hoover



Gas Sampling Pump 1950

The printed scale allows a direct reading of the concentration. Thus, calibration by the user is not necessary. Of course the length-of-stain discoloration does not correspond to the concentration as a direct measure but is, strictly speaking, a measure of the mass reaction of the air contaminant with the Dräger-Tube preparation. Since the information that 25 mg of nitrogen dioxide has reacted is not practical information for the workplace, the calibration scale is prepared in the engineering units ppm or volume percent.

For many years, only a few gases could be measured with detector tubes. The main area of application was and still is the measurement of air contaminants in the workplace, in the concentration range of the occupational exposure limits. Decreasing occupational exposure limits have made it necessary to develop more sensitive Dräger-Tubes. In addition, efforts to better understand the exposure profile in the workplace have resulted in special Dräger-Tubes for long-term measurement which determine time weighted averages over given time periods.

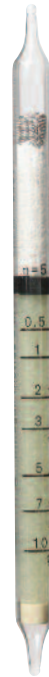

ST-138P-2001

Dräger-Tubes can be schematically classified utilizing the following criteria:

Dräger-Tube
Nitrogen Dioxide 0.5/c

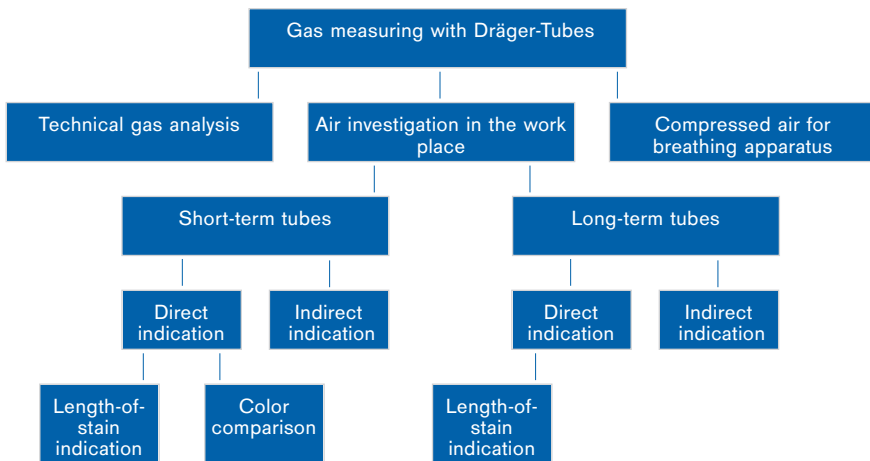

Distinction is made according to the fundamentally different areas of application:

- **Air investigation in the workplace**
Measurements in the range of the occupational exposure limits.
- **Technical gas analysis**
Dräger-Tube measurements in the area of emission concentrations.
- **Compressed air for breathing apparatus and compressed gases**
Specially calibrated Dräger-Tubes used with the Dräger Aerotest to determine the quality of compressed breathing air. The typical contaminants are CO, CO₂, water and oil.

Short-term tubes are designed for on-the-spot measurements at a particular location over a relatively short time period. Short-term tube measurements may last from 10 seconds to 15 minutes or so depending on the particular Dräger-Tube and sampling pump. Some applications for short-term tubes are the evaluation of concentration fluctuations in the workplace, the measurement of contaminants in the workers' breathing zone, the investigation of confined spaces (e. g. grain silos, chemical tanks, sewers) prior to entry and to check for gas leaks in process pipelines.

Suitable pumps for Dräger short-term tubes are:

- **Dräger-Tube pump accuro**
- **Dräger X-act 5000, ex-approved, automatic Dräger-Tube pump**

For long-term measurements Dräger-Diffusion-Tubes with direct indication and sampling tubes and systems are available. Long-term measurements with diffusion tubes provide integrated measurements that represent the average concentration during the sampling period. Normally the measurements are performed between one and eight hours. These tubes can be used economically as personal monitors or area monitors to determine the weight average concentration. In contrast to short-term tubes, no pump is necessary for sampling with these measurement devices. The contaminant molecules automatically move into the tube or onto the badge, according to Fick's First Law of Diffusion.

The driving force for this movement of the contaminant molecules is the concentration differential between the ambient air and the inside of the tube. Since the diffusion tubes do not require a pump, they are particularly effective as personal gas monitors.

When complex substances or components that are chemically very similar, like methanol, ethanol, and propanol are present, direct reading Dräger-Tubes approach their limits of use. A colorimetric reaction system based on a iodine pentoxide cannot distinguish between aliphatic hydrocarbons and indicates the sum of the concentration. In this example, the aliphatic hydrocarbons are indicated with almost the same sensitivity. Solvents usually consist of three to five different components, all chemically very similar. The use of a single Dräger-Tube in this case would not yield reliable results without any previous knowledge because of possible and probable cross sensitivities. In cases such as these, a sample should first be collected using a sampling tube which is then sent to a laboratory for analysis. The analysis will be conducted using gas chromatography or a photometric analysis technique.



ST-1350-2004

Direct reading diffusion tube with holder

Dräger sampling tubes contain coconut shell charcoal, different types of silica gel, or molecular sieve. The sampling tubes do not produce a color change and therefore can be described as indirect indicators. The sampling of isocyanates is accomplished using a specially prepared Dräger sampler which is analyzed after sampling via HPLC procedures.

After the analysis with sorbent sampling tubes it is often possible for subsequent measurements to be performed economically with direct reading short-term or long-term tubes targeted for particular components of a mixture.



ST-174-2004

Dräger diffusion sampler ORSA

In order to choose the best Dräger-Tube for the particular application, an assessment of the measurement with regard to the ambient conditions and the possible limits of use is very important. This assessment ensures that the advantage of the Dräger-Tube method does not turn into a disadvantage due to unforeseen cross sensitivities.

In any case, although the Dräger-Tube is an easily operated gas measurement method, it belongs in the hands of specialists. People trained in the field of industrial hygiene should be capable of determining the time and place to monitor, to recognise possible cross sensitivities, and to interpret measurement results correctly.

For all gas analysis tasks Dräger provides competent and extensive service beyond the initial sale of its products. This service includes:

- free consultation for specific questions on measurements with Dräger-Tubes,
- ¹⁾analysis of loaded samplers in the laboratory of the Dräger analysis service
- ¹⁾measurement and sampling on site with analysis in the laboratory of the Dräger analysis service according to official regulations,
- Internet information system VOICE: www.draeger.com/voice
- Seminars about special subjects

¹⁾This service is based in Germany.

2.2 Chemical Basics – Reaction Mechanisms

The basis of any direct reading Dräger-Tube is the chemical reaction of the measured substance with the chemicals of the filling preparation. Since this reaction leads to a discoloration, the Dräger-Tubes can also be called colorimetric chemical sensors. The substance conversion in the Dräger-Tube is proportional to the mass of the reacting gas. Generally it is possible to indicate this substance conversion as a length-of-stain indication. When a length-of-stain indication is not practical, the alternative is a Dräger-Tube with the indication based on interpretation of color intensity according to a given reference standard or set of standards.

The filling layers of Dräger-Tubes are comprised of different reagent systems. There are essentially 14 reagent systems used in Dräger-Tubes and in some cases these reagents are combined in the same tube to give desired effects. For the Dräger-Tube user the selectivity of the individual tube is very significant. The spectrum of selectivity of Dräger-Tubes ranges from the substance selective Dräger-Tubes for carbon dioxide to tubes which are selective to substance groups (e. g. chlorinated hydrocarbons), to the class selective Dräger-Tube like the Polytest tube which indicates many easily oxidizable substances. The Dräger-Tube user has many options available when using Dräger-Tubes. This handbook is intended to help sort out those options.

One of the classic Dräger-Tube reactions is the conversion of iodine pentoxide under acidic conditions to iodine by reaction with carbon monoxide. While it is basically a class selective reaction for the measurement of easily oxidizable substances, the selectivity can be increased by suitable prelayers:

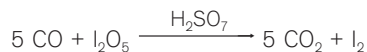

Precipitation reactions of metal salts are the basis of hydrogen sulphide tubes. Metal salts react with hydrogen sulphide and form slightly soluble metal sulphides. This is a fast ion reaction which is nearly independent of the flow rate through the Dräger-Tube. In order to make this reaction occur, a small amount of water, i.e. humidity, is necessary:

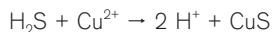

Nitrogen dioxide and elementary halogens react with aromatic amines by forming intensely colored compounds:



Since chlorinated hydrocarbons are not indicated by direct colorimetric reaction, an oxidative cleavage of the molecule is necessary as a first step. This reaction is done with potassium permanganate, which forms elementary chlorine. The chlorine then reacts with the reagent preparation in the indicating layer to produce the colorimetric reaction product.

The measurement of carbon dioxide is done by oxidation of hydrazine hydrate in the presence of crystal violet as an oxidation-reduction (redox) reaction:



Typically carbon dioxide will be present at a substantially higher concentration than any potentially cross sensitive substances, therefore this reaction is very selective. Possible interferences by hydrogen sulphide and sulfur dioxide are not expected since these interferences can only occur with unusually high concentrations.

Another large group of Dräger-Tube reactions is based on pH indicators, for example:



This type of reaction is valid for basic as well as acid gases.

Compounds containing the $\text{C}\equiv\text{N}$ -group are measured using multiple stage reactions. In the case of acrylonitrile, the first step is a oxidation. In the next step the cyanide ion reacts with mercury chloride to form hydrochloric acid and undissociated mercury cyanide. The hydrochloric acid is indicated in the last partial step of this complex reaction system by means of a pH indicator. Suitable prelayers are used to ensure a selective measurement. A similar reaction principle is also used in the most sensitive hydrogen phosphide (i. e. phosphine) tubes, Phosphine 0.01/a. The hydrogen phosphide also reacts with mercury chloride, but in this case yields mercury phosphide and hydrochloric acid. Again, the hydrochloric acid is indicated by means of pH-indicator.

Most hydrides of the elements from group III or V of the periodic table (e.g. borane or arsine), react because of their reducing characteristics with gold salts by forming elemental gold.

Aromatics condense under strongly acidic conditions with formaldehyde to form intensely colored quinoid compounds with different molecular structures.

Each of these reaction partners can be measured on this basis; aromatics like benzene and xylene as well as formaldehyde. For ethylene oxide and ethylene glycol an additional oxidation reaction is necessary, in which both substances are converted into formaldehyde.

The oxidation effect which sulfur dioxide has on iodine complexes (i.e. iodine with starch) results in a bleaching or discoloration of the colored indicator to a neutral white. This reaction is the basis of several Dräger-Tubes for sulfur dioxide.

Substituted aromatic amines react relatively selectively with acetic chlorides and phosgene, where the latter can be seen as dichloride of the carbonic acid. Carbon tetrachloride is oxidised by a strong oxidation agent into phosgene, so that this type of reaction is also suitable for the measurement of carbon tetrachloride.

The oxidation reaction of C=C double bonds with potassium permanganate is the basic reaction of the Dräger-Tubes for the measurement of olefins (i.e. alkenes). Other substances which are oxidised by permanganate (e.g. perchloroethylene) will also be indicated.

Another reduction reaction of metal salts permits the measurement of ethylene and some acrylates. Molybdate salts show an intensive discoloration from light yellow to dark blue when reduced from the highest oxidation stage to a lower one.

Substance selective reactions which have not been mentioned include:

- ketone detection with hydrazine derivatives,
- oxidation of titanium (III) salts by oxygen,
- nickel detection by dimethylglyoxime.

The limits of the gas detection method must be considered when attempting to conduct an analytical determination. It is important with regard to the selectivity to know about potential cross sensitivities. Considering the exhaustive list of potential chemical substances, it is not possible to list all potential interferences. When questions about Dräger-Tubes arise, they should be directed to the local Dräger subsidiary or distributor.

2.3 Dräger-Tube Measurement System

The Dräger-Tube measurement system consists of a Dräger-Tube and a Dräger-Tube pump. Each Dräger-Tube contains a very sensitive reagent system that produces accurate readings when the technical characteristics of the gas detector pump precisely match the reaction kinetics of the reagent system in the tube. Therefore, a gas detector pump, delivering the correct volume must also pull the sample through the Dräger-Tube at the proper rate. These requirements are referenced in international as well as national detector tube standards or norms which require or recommend that detector tubes be used with a matching gas detector pump from the same manufacturer.

Different Dräger-Tube pumps and Dräger-Tubes are used for the Dräger-Tube measurement system. Dräger short-term tubes and the Dräger-Tube pumps are matched with each other at the factory. They form one unit. Using other pumps with Dräger short-term tubes or other short-term detector tubes with Dräger-Tube pumps can impair the proper function of the measurement system. To get accurate results with this system, each type of Dräger-Tube is calibrated in batches, along with a Dräger-Tube pump. If short-term detector tubes and pumps from different manufacturers are used, there is no guarantee that the detector tube measurement system will perform as described in the instructions for use, and it can lead to significant discrepancies in the results.

Following examination by the German Institute for Occupational Safety and Health (IFA), the Dräger-Tube pump *accuro*, for example, complies with the requirements of DIN EN 1231.

Dräger-Tube pumps

Dräger-Tube pumps can be used for short-term measurements and sample taking. Short-term measurements are on-the-spot measurements, e. g. the evaluation of concentration fluctuations, release measurements, worst case measurements etc. With a sample taking, first of all the substances to be measured are collected on a suitable medium, e. g. activated charcoal, silica gel etc. First, the air to be evaluated is drawn over the respective medium - normally at a defined volume flow (= flow rate) for a specified duration. Then, the substances collected on the medium by adsorption or chemisorption are analyzed qualitatively and quantitatively in the laboratory by means of analytical methods such as gas chromatography (GC), high performance liquid chromatography (HPLC), UV-VIS photometry or IR spectroscopy.

The following Dräger-Tube pumps are available for these measurements:

- **Dräger *accuro*, Dräger-Tube hand pump**
- **Dräger X-act 5000, ex-approved automatic Dräger-Tube pump**

Basically all Dräger-Tube pumps are to be used according to the appropriate instructions for use.

Dräger-Tube pump *accuro*

The Dräger-Tube pump *accuro* is a bellows pump. It can easily be operated with one hand and draws in 100 ml per stroke. When measuring, the pump body (bellows) is pressed together completely. This corresponds to one "stroke". During the stroke the air contained in the pump chamber escapes through the exhaust valve. The suction process runs automatically after the bellows are set free. The exhaust valve is closed during the opening phase of the bellows so that the gas sample flows through the connected Dräger-Tube into the pump. After the complete opening of the pump body into its original position the suction process is finished. The end of stroke is visible by a pressure-controlled end of stroke indication, located in the pump head. An internal scissor mechanism built into the Dräger *accuro* pump bellows provides parallel compression of the pump and an automatic stroke counter which is integrated in the pump head records the number of strokes.

The Dräger-Tube pump accuro is independent of external energy sources. Therefore, there are no usage restrictions in areas of explosion hazard.



ST-2436-2003

Dräger-Tube pump accuro

Technical data	Dräger-Tube pump accuro
Application	For short-term measurements with a small numbers of strokes
Design	Hand-operated bellows pump, one-handed operation
Number of Strokes	1 - 50 strokes and higher
Stroke volume	100 mL (±5%)
Dimensions (H x W x D)	approx. 85 x 170 x 45 mm
Weight	approx. 250 g
Protection class	(not required)
Battery	(not required)

Tube pump Dräger X-act 5000

Dräger X-act 5000 is an ex-approved automatic tube pump for the measurement or sample taking of gases, vapors and aerosols. The Dräger X-act 5000 is based on a completely new pump concept. The key principle is the electronic pump control for using Dräger short-term tubes and to perform sample taking with sampling tubes and systems. This pump control provides the required flow characteristics of the Dräger short-term tubes. Compared to the Dräger accuro hand pump, this new concept reduces the average measurement time of the Dräger short-term tubes with higher numbers of strokes. For a sample taking all parameters can be set directly. The internal pump is also designed to use extension hoses up to a length of 30 meters.

All components of the pump are built in a robust housing. The components of the pump are corrosion resistant and the pump is additionally equipped with an internal user



D-13280-2010

Tube pump Dräger X-act 5000

replaceable SO₃ filter which traps sulfur trioxide aerosols protecting the pump for up to two years. The two-part display (segment and matrix part) has a bright backlight to enable the use of the pump under poor lighting conditions. Dräger-Tubes, sampling tubes and systems and accessories can easily be connected.

A simple and intuitive menu structure provides the user efficient operation. After it is switched on, a startup screen appears and an automatic self-test is conducted. After the startup procedure, the user is prompted to carry out a leak test. After this test is carried out or skipped, the various operating modes are shown. The following operating modes are available:

- Measurement with short-term tubes
 - Measurement in air
 - Barcode operation in air
 - Manual operation in air
 - Measurement in technical gases
- Sample taking

To support a convenient operation a barcode reader is integrated in the Dräger X-act 5000. If the "Barcode operation in air" mode is selected, a barcode will be scanned using the barcode reader of the device to transfer the relevant measuring data into the pump. This barcode is printed on the label of the backside of the Dräger short-term tube box. Simply sliding this barcode over the barcode reader of the pump automatically transfers the required parameters into the pump. The transferred data will be indicated on the display:

- Part number of the Dräger-Tube
- Name of the substance to be measured
- Measuring range(s)
- Number of strokes for the respective measuring range
- Additional information, if applicable

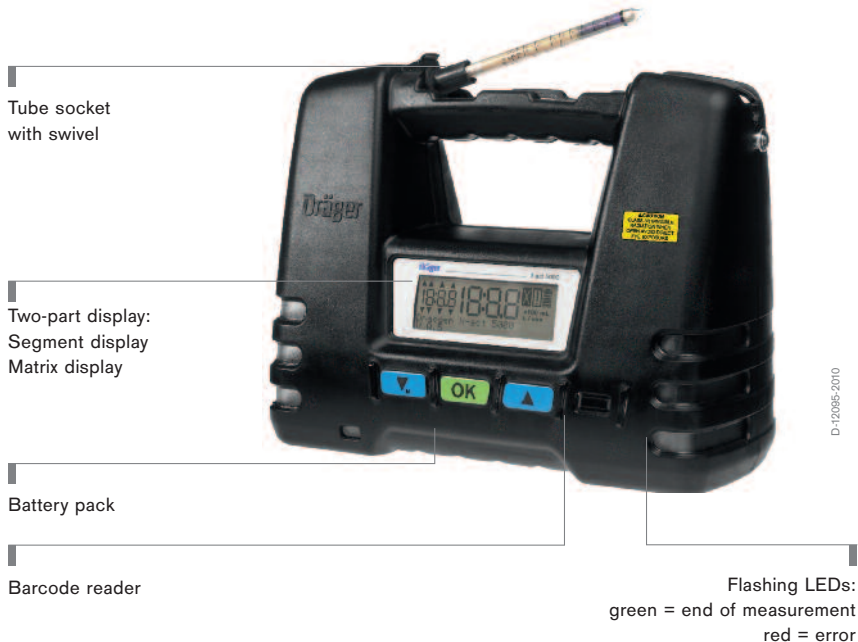

The Dräger short-term tubes are calibrated for the measurements in ambient air. For measurements in technical gases the different viscosity of the technical gas, compared to the viscosity of ambient air, has to be taken into consideration. In the operating mode "Measurement in technical gases" the required flow rate is adjusted by the pump. Therefore the display prompts the user to prepare the measurement with an additional operating step.

Once measuring has finished, the measurement result can be read directly from the tube. Directly setting the volume flow (= flow rate) and the duration of the sample taking reduces the preparation time for a sample taking accordingly. The Dräger X-act 5000 automatically adjusts the set flow rate. An additional adjustment of the system using an external flow meter is not necessary. After setting the sampling time the pump can immediately be started. At the end of the set sampling time, the pump will stop automatically. The set data, the elapsed time, and the pumped volume will be indicated on the display.

The Dräger X-act 5000 is shipped from the factory with the display in English. The menu language can be changed from a password-protected menu. Other languages are available. Recurring operating modes and other necessary functions can be set or selected in order to customize operation for the respective application.

Technical data	Dräger X-act 5000
Application	For short-term measurements with higher numbers of strokes and sample taking with sampling tubes and systems.
Design	Menu-driven, automatic pump
Number of strokes	adjustable, 1 - 199 strokes
Stroke volume	100 ml (\pm 5%)
Dimensions (H x W x D)	approx. 175 x 230 x 108 mm
Weight	approx. 1.6 kg (without battery pack)
Protection class	Ex-approved IP 64
Battery packs	NiMH Battery, T4, 7,2 V, 1500 Ah (charging time < 4 h) Alkaline Battery Pack, T4, 6 AA batteries, (see Instructions for use)
Barcode reader	<p>The Dräger X-act 5000 has a built-in barcode reader which emits an invisible laser beam during normal operation. The Dräger X-act 5000 is a Class 1M LASER Product with Class 3R internal Radiation per the requirements of IEC 60825-1 Edition 2.0 (2007).</p> <p>INVISIBLE LASER RADIATION DO NOT VIEW DIRECTLY WITH OPTICAL INSTRUMENTS CLASS 1M LASER PRODUCT</p> <p>Viewing the laser output with certain optical instruments (for example, eye loupes, magnifiers and microscopes) within a distance of 100 mm may pose an eye hazard.</p>

Functional capability of Dräger-Tube pumps

To help ensure precise measurement results, it is particularly important to confirm that the pump is operating properly. Short-term pumps should be checked before each measurement for leaks and suction capacity according to the operating manual. In addition, after a measurement short-term pumps should be flushed with clean air by performing several strokes without a Dräger-Tube in the pump. This purges the pump of reaction products which enter the bellows due to the reaction in the tube.

Inspection of the Functional capability using the example of Dräger accuro

Insert an unopened Dräger-Tube and squeeze the pump completely.

After releasing the position of the pump body should not change within one minute.

Squeeze the pump completely.

After releasing, the pump must open instantly.

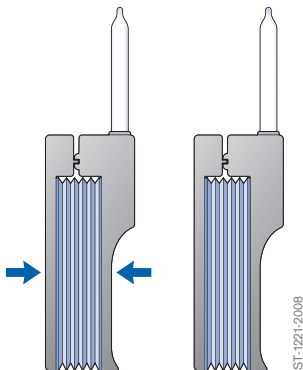

Quick test to check bellows pump for leaks

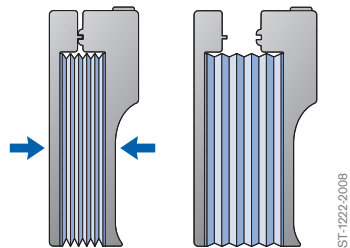

Quick test to evaluate the suction capacity of the bellows pump

2.4 Dräger-Tubes for Short-Term-Measurements

Short-term tubes are intended for the measurement of momentary concentrations. The duration of a short-term measurement is usually in the range of 10 seconds to 15 minutes. The measured value shows the actual concentration during the time period covered by the test.

The design of the short-term tube depends on the measurement task, particularly on the substance to be measured and the concentration range to be determined. There are several types of Dräger short-term tubes:

- tubes with a single indication layer,
- tubes with one or more pre-layers plus an indication layer,
- combination of two tubes,
- tubes with connecting hoses,
- tubes with a built in reagent ampoule,
- tubes for simultaneous measurement

Short-term tubes with a single indication layer

The whole filling layer in these tubes serves as the indication layer.

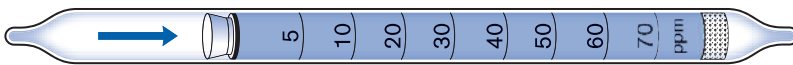

Dräger-Tube with a single indication layer

Examples include: Hydrazine 0,25/a
Ammonia 0,25/a

Short-term tubes with one or more pre-layers

In addition to the indication layer they have one or more pre-layers. These pre-layers are designed to:

- adsorb moisture or**
- trap interfering substances or**
- convert substances into measurable substances**

Examples include: Alcohol 100/a,
Hydrochloric Acid 1/a

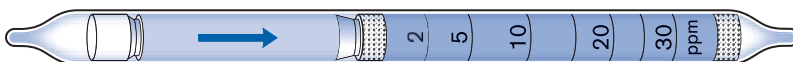

Dräger-Tube with one prelayer

Combination of two Dräger-Tubes

Two Dräger-Tubes, a pre-tube and an indication tube, are connected with shrink wrap tubing. Prior to the measurement, both inner tips and outer tips must be opened to allow air to be drawn through both tubes. The preparation in the pre-tube serves a purpose similar to the pre-layer of a single tube.

Examples include: Halogenated Hydrocarbons 100/a,
Formaldehyde 0.2/a

Short-term tubes with connecting tubes



ST-1225-2008

Combination of two Dräger-Tubes

These tubes consist of one indication tube and an additional tube. After breaking off the tube tips both tubes are connected with a short piece of rubber tubing supplied with the tubes. The additional tube must be connected in front of or behind the indication tube according to the instructions for use. If connected behind the indication tube, it functions as an adsorption layer for reaction products which result from the reaction in the indication tube. If it is connected in front of the indication tube, it functions similarly to the pre-layer in a standard Dräger-Tube.

Examples include: Oxygen 5%/B



ST-1225-2008

Dräger-Tube with pre-tube

Short-term tubes with a built-in ampoule

Due to chemical incompatibility some reagents must be kept separate until just before the actual measurement. These tubes feature a built-in reagent ampoule in addition to the indication layer. The compound in the ampoule can be vaporous, liquid, or solid (i. e. granular).

Examples include:

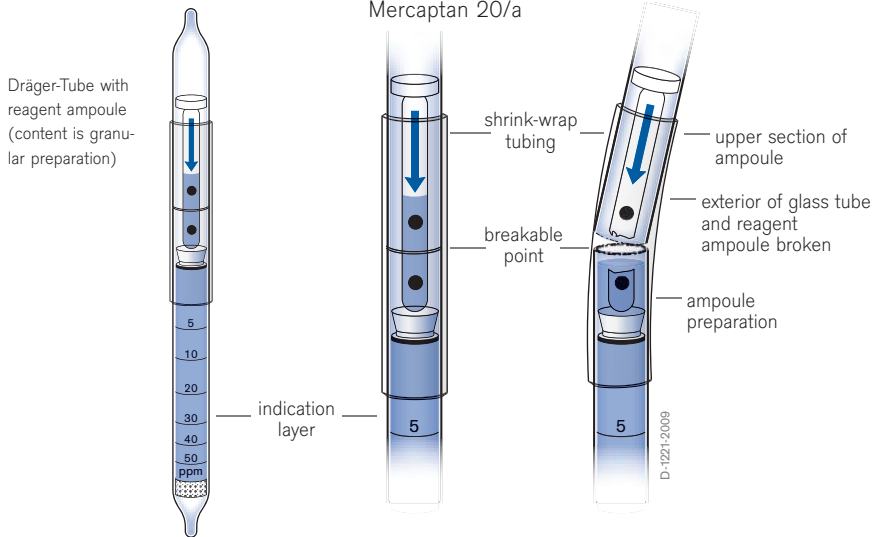

Dräger-Tube with built-in reagent ampoule

Dräger-Tubes for simultaneous measurement

A set of five specially calibrated tubes are provided in a rubber fixture. Each tube has one or two calibration marks for semiquantitative evaluation. The tips of all five tubes are broken and the set is connected to a five tube adapter which is connected to the Dräger-Tube pump (e. g. accuro) and the air sample is drawn through all five tubes simultaneously. Since the test sets are designed as a system, the use of other tubes is not recommended and will lead to erroneous results.



Test Set I for simultaneous measurement of inorganic combustion gases.

Examples include: Dräger Simultaneous Test Set I and II measurement of inorganic combustion gases. Dräger Simultaneous Test Set III measurement of organic vapors.

2.5 Evaluation of Dräger-Tubes

The evaluation of the indication on the Dräger-Tube is another important factor to be taken into consideration. The following are guidelines for interpreting the indication:

- continuously observe the tube during the measurement
- evaluate the indication immediately following the measurement according to the instructions for use
- use sufficient lighting
- light background
- compare with an unused tube

Observing the tube during the measurement is particularly important to make sure that a complete discoloration of the tube has not happened without being realised. This complete discoloration can sometimes occur abruptly with high concentrations even during the course of the first stroke.

A sufficient lighting source is necessary. However, direct sunlight should be avoided because the UV-radiation of the sun may cause a change in the discoloration. Since such a change can sometimes occur even after a longer period of time.

The reading of the tube must be done immediately following the measurement.

Also, keeping the used tube as proof is not useful in most cases, because even tubes which have been sealed with rubber caps will show a change in the indication over time.

A light background (white paper) is very helpful, in improving the readability of the discoloration. When there is no source of ambient lighting the reflector of a switched-on flashlight will suffice.

The comparison of a used tube with an unused one is yet another way to more accurately evaluate the discoloration.

In all cases the entire length of the discoloration must be read. This means the sum of all colors (e. g. carbon monoxide tubes produce light brownish green discolorations).

It must also be pointed out that an individual's perception of a particular color or intensity of a color is somewhat subjective. It is possible, for example, that one person calls a color light brown whereas another person calls the same color brown. These deviations in the individual perception of color or sense of color should not be overemphasised unless color blindness is an issue.

When reading the concentration on a scaled tube, three different situations can be encountered:

- the color indication ends at a right angle to the tube's longitudinal axis
- the color indication is oblique to the tube's longitudinal axis
- the end of the color indication becomes very diffuse

When the color indication is at a right angle to the tube's longitudinal axis, the concentration can be read directly against the scale (see example 1). If the color indication is oblique (i. e. runs in a slanting direction to the tube's longitudinal axis), then a long and a short discoloration can be observed. In this case the average reading indicates the concentration (see example 2). If the color indication become progressively diffuse, the end of the discoloration may be difficult to evaluate. In this case the final edge of the discoloration has to be read at the point where a faint discoloration is just visible (see example 3)

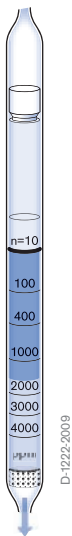

Example 1

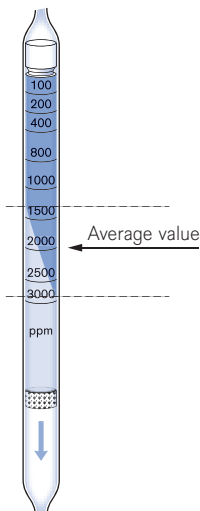

Example 2

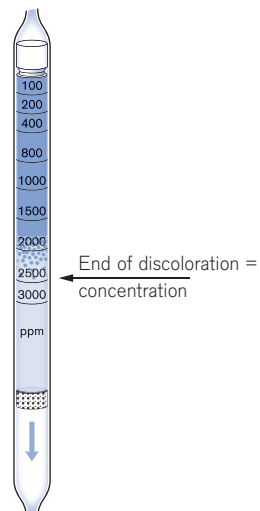

Example 3

2.6 Hot Air Probe

The hot air probe was developed for the measurement of hot gases. This probe is required when the temperature limit (usually up to 40 °C / 104 °F) given in the operating instruction sheet is exceeded.

At a higher temperature the volume of air drawn with the Dräger-Tube pump changes. Normally, the volume is 100 mL per pump stroke at 20 °C. The temperature dependence of the volume can be explained with Gay-Lussac's law.

$$V_t = \frac{V_0}{T_0} T$$

The hot air probe is designed to cool down hot gases so they can be measured directly with the Dräger-Tube system. If it is ensured that the probe does not remain in the gas flow for more than half a minute, even gases at a temperature of e. g. 400 °C are cooled to below 50 °C. The dead air space of the probe is so small that it can be ignored while measuring.

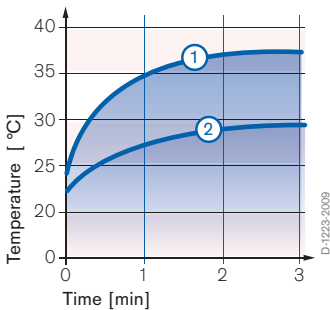

D-11223-2009

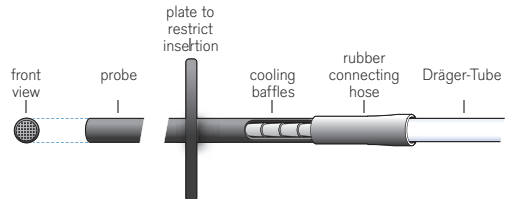

D-11224-2009

Cooling effect of the hot air probe

gas temperature: 650 °C

ambient temperature: 20 °C

In 3 minutes 1 L of gas was drawn and the temperature in the tube rose according to the above curves

(1) with one hot air probe

(2) with two hot air probes

Sketch of the hot air probe

2.7 Extension Hose

An extension hose provides a convenient means to test the air quality in difficult to reach areas such as grain silos, storm drains, sewers and tanks, prior to entry. One end of the hose is equipped with an adapter to connect the extension tube securely to the Dräger-Tube pump. The other end of the hose has a tube holder assembly which provides a gas tight fit when the Dräger-Tube is inserted. The extension hose is made of a fuel resistant synthetic rubber.

Since the Dräger-Tube is connected at the inlet of the extension hose and the Dräger-Tube pump is connected at the outlet end of the extension hose, the volume of the hose has no influence on the reading. However, when extension hoses longer than the standard 3 m hose are used, correction factors or additional time to draw the sample may be required and should be reviewed with the local Dräger subsidiary or distributor.

2.8 Determination of the Carbon Monoxide Content in Exhaled Air

The Respiratory CO Test is used for the determination of the concentration of carbon monoxide in the blood. There is a very close relationship between the carbon monoxide content of exhaled air (alveolar air) and the level of carbon monoxide saturation of the blood. The Respiratory CO Test provides a convenient and reliable means to measure the carboxyhemoglobin (HB-CO) content of the blood.



Respiratory CO Test measurement

As a follow-up to the carbon monoxide measurements made at the work place, the Respiratory CO Test provides vital information about the exposure to the individual. People working in areas where the carbon monoxide concentration is fluctuating (e. g. highway toll booths, parking garages) should be checked regularly.

To perform the test, exhaled air is blown through a resistance tube into a 1 L sampling bag. The air sample is drawn out of the sampling bag through a Dräger-Tube (calibrated in percent carboxyhemoglobin) using the Dräger-Tube pump. The exhaled air consists of a mixture of alveolar air and tidal air. Using the sampling bag, the alveolar air makes up approximately 70% of the sample air. This is a highly reproducible ratio and the respiratory CO Tube can be directly calibrated in percent carboxyhemoglobin.

2.9 Investigation of compressed Air, Medical Gases and Carbon Dioxide

In accordance with DIN EN 12021, compressed air used as breathable air must meet certain quality requirements. For example, air in an unloaded state cannot contain more than 5 ppm of carbon monoxide or 500 ppm of carbon dioxide. The water content in unloaded air, in the case of a drop in pressure of 40 to 200 bar, must be below 50 mg/m³. In the case of a fall in pressure of >300 bar it must be below 35 mg/m³. In case of a drop in pressure of 5 to 40 bar the permitted water content is listed in a table of the standard DIN EN 12021. Furthermore, unloaded air must also be free from odor or taste (this is generally guaranteed if the oil content is below 0.1 mg/m³). In addition, the water content of unloaded air released by the compressor must not exceed the total pressure range of 25 mg/m³ (DIN EN 12021).

In order to check these parameters, as well as to satisfy the intended application of the various media in the form of application-specific and country-specific regulations, a quantitative test of the medium can be performed using the Aerotest line of products. Dräger has been active for over 100 years in the field of compressed air analysis. The Aerotest line of products allows simultaneous measurement of pollutants in outgoing air, as well as in oxygen and carbon dioxide. Dräger-Tubes form the basis for these measurements. The Simultan Aerotest and tubes make it possible to take a measurement in just 5 minutes. The volume flow required for the pollutant measurement (flow through Dräger-Tubes) is realized using a precise pressure relief valve and special dosage devices. Regardless of the compressor's primary pressure (max. 300 bar), the loop, or the respective residual filling pressure in the buffer cylinders, a consistent volume flow can be supported. The Aerotest Simultan is a compact design and can be connected to standard compressors, buffer cylinders, or loops without the use of additional tools.



Dräger Aerotest Simultan

In 2008, measurement using impactor technology was introduced, in order to detect oil mist in compressed air. In general, impactors collect aerosol particles, making this technology excellently suited to detecting oil mists.

The impactor is used together with an adapter in the Dräger Aerotest Simultan.

During the measurement, the air to be inspected flows through 20 nozzles in the impactor, before hitting a baffle-plate, made of cut glass, at right angles. The 90° redirection of air in the impactor separates the aerosol particles in the air flow on the glass plate due to their high inertia. The recesses in the glass grinding are then filled with the oil. This nullifies the light diffusion caused by the glass grinding. This principle allows for the visual recognition of small quantities of oil.



Impactor with Adapter in
Aerotest Simultan

Due to the special arrangement of the nozzles, the quantity of separated oil, and therefore the oil aerosol concentration if the air quantity is known, can be measured with good reproducibility.

The measurement result is independent on the oil grade. However, note that oil aerosols vaporize at high temperatures, and the vapor is not shown. The measurement lasts 5 minutes with a volume flow of 4 L/min, making a test volume of 20 L.

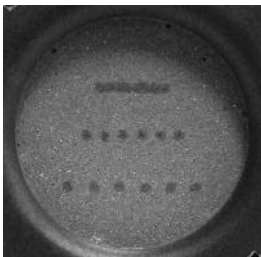

0.1 mg/m³

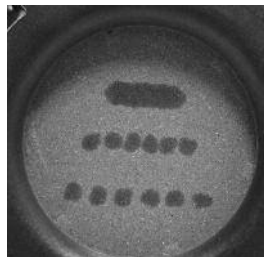

0.5 mg/m³



1 mg/m³

Impactors with 3 different oil aerosol concentrations.

Dräger Aerotest 5000**64 01 220**

The Dräger Aerotest 5000 is used to measure the quality of breathing air delivered by a low-pressure system 2,5 to 10 bar (e.g. compressor or compressed air cylinder). The quality of the breathing air can be tested in accordance to DIN EN 12021 by means of quantitative measurements of the contaminations. Dräger-Tubes or Dräger Impactor are used for measuring. The values can be measured both simultaneously or individually. Data can be stored. All components of the Aerotest 5000 are arranged in a carrying case ready for use. Optional measurements by high pressure systems with pressure regulator F3002 can be used.



D-11163-2011

Dräger Aerotest 5000

Dräger Aerotest Simultan HP, complete 65 25 951

For checking breathable air in high-pressure areas. The monitoring of the breathing air quality according to the requirements of EN 12021 is performed by means of a quantitative measurement (of the contaminations) in the compressed air flow within 5 minutes. The measuring device (G 5/8" connection DIN 477) can be connected to the high-pressure compressed air supply system to be monitored. All components of the Aerotest Simultan HP are arranged in a carrying case and ready for use.



ST-7001-2008

Dräger Aerotest Simultan HP, complete

Dräger Aerotest Alpha, complete 65 27 150

For checking breathable air in low-pressure areas of 3 to 15bar. The monitoring of the breathing air quality, according to the requirements of DIN EN 12021, is performed by means of quantitative measurement (of the contaminations) in the compressed air flow. The measuring device (barbed fitting connection) can be connected to the low-pressure compressed air supply system to be monitored. All components of the Aerotest Alpha are arranged in a carrying case and ready for use.



ST-7001-2008

Dräger Aerotest Alpha, complete

Dräger MultiTest med. Int., complete 65 20 260

For checking medical gases in supply systems. The Multitest med. Int. and Dräger tubes can be used to detect contamination in compressed air, laughing gas, carbon dioxide and oxygen, in accordance with USP (United States Pharmacopeia) requirements. Dräger tubes are used for the quantitative detection of water vapor, oil, CO₂, SO₂, H₂S, NO_x, CO and other contaminations in medical gases. The measuring device is connected with the various barbed fitting adapters. All components of the MultiTest med. Int. measuring device are stored in a handy carrying case.



ST-1368-2004

Dräger MultiTest med. Int., complete

Dräger Simultan Test CO₂, complete 65 26 170

For checking carbonates (CO₂) in low-pressure areas of 3 bar. The monitoring of carbonates is performed by means of quantitative measurement (of contaminations) in the carbon dioxide flow. The measuring device (barbed fitting connection) can be connected to the carbon dioxide tube system to be monitored. Dräger tubes are used for the quantitative detection of water vapor, NH₃, NO_x, CO, SO₂, H₂S and other contaminations in carbon dioxide. All components of the Simultan Test CO₂ measuring device are stored in a handy carrying case.



ST-1368-2004

Dräger Simultan Test CO₂, complete

Dräger Aerotest Navy, complete 65 25 960

The device determines the quantity of hydro steam, oil, CO₂, CO and other contaminations in the air flow supplied by high-pressure compressors or compressed air at a max. pressure of 300 bar. The pressure is limited by a pressure reducer. The air to be monitored is tested by means of a flowmeter. The compressed air is supplied through a special direct scanning tube, which analyzes the quantity. The monitoring of the breathable air quality is performed in accordance with DIN EN 12021. All components of the Aerotest Navy are stored in a handy carrying case.



Dräger Aerotest Navy, complete

2.10 Proposed Strategy for Determining Gas Hazards

The measurement of air pollution presents a special challenge especially when encountered at hazardous waste sites, fires, or transportation accidents involving chemicals. In this case, a risk analysis is hindered by the possible existence of several contaminants in the air.

In addition to portable gas detection instruments, Dräger-Tubes and Dräger Chips can be used for on-site measurements and to assist in the identification of gaseous substances. Because of the diverse possibilities regarding the substances, it is not possible to only use a single Dräger-Tube or Chip to determine all the imaginable combinations of gas dangers. Taking into account certain considerations and experiences, a suggestion for a measurement strategy has been developed. With this strategy, the time to make a first classification of the most important substance groups can be considerably shortened.

Of course, every suggestion is more or less the best possible compromise, when the practicability is complicated by a growing uncertainty.

Multiple test sets

For these special applications, Dräger has developed multiple test sets for carrying out simultaneous measurements. Each set consists of five specially calibrated tubes assembled in a rubber fixture. At this time there are two sets available for the measurement of inorganic combustion gases (Dräger Simultaneous Test-Set I and II) and a third set, for the measurement of organic substance groups (Dräger Simultaneous Test-Set III).

The use of such multiple measurement devices has substantial advantages compared with individual Dräger-Tube measurements:

- significant reduction of the measuring time
- detection of five contaminants and the relative concentrations at once

The Dräger Simultaneous Test-Sets are delivered pre-assembled and are connected to the Dräger-Tube pump via an adapter after opening the tube tips.

The Dräger-Tubes that make up each set do not have complete calibration scales. Instead, they have one or two calibration marks. These marks are orientated on the limit values for workplaces. To achieve the same air flow through each tube, the individual flow resistances of the Dräger-Tubes are very carefully matched, therefore, no other detector tubes can be used as substitutes in the rubber fixture.

Using three concentration sections the evaluation of the Simultaneous Test-Sets can be basically classified:

- non critical concentration range
- critical concentration range
- highly critical concentration range

The concentration range is indicated by the length of the discoloration. The following drawings describe the evaluation of the single tubes in the Simultaneous Test-Sets. In the

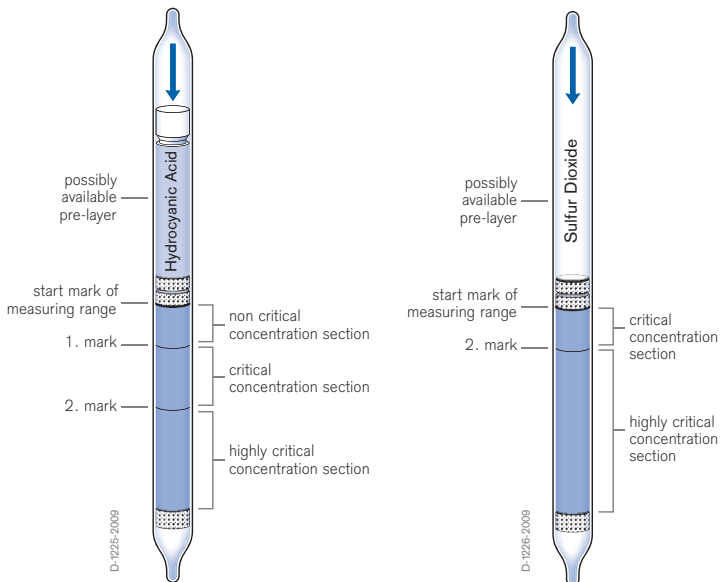

Simultaneous Test-Set II there is a special evaluation of the Dräger-Tubes for chlorine, phosgene and sulfur dioxide. On these tubes, the second mark is missing.

Whenever the concentration of a gas is critical or highly critical the actual concentration of this gas is verified using the respective Dräger-Tube.

A decision about possible measures always depends on how the concentration of the emerging gas will develop. In addition, the individual ambient conditions must be taken into account. Therefore, decisions can principally only be made by the incident commander on site.

Measurement of combustion and decomposition gases

In every fire, combustion and decomposition gases are evolved. There is danger of combustion and decomposition gases developing in higher concentrations during and particularly after the fire. These gases present a significant toxicity hazard for persons in the immediate as well as adjacent areas. These areas include e. g.

- adjoining rooms
- adjacent floors
- adjacent buildings
- neighboring streets

To realise the full benefit of these tests, both sets must be used, otherwise hazardous gases with poor warning properties could be overlooked.

Studies have shown that more than 450 substances are evolved as the result of fire. While all of these gases are not present in every fire, there are 11 inorganic gases that are most commonly present. Ten of these gases are measurable using the

- Dräger Simultaneous Test-Sets I and
- Dräger Simultaneous Test-Set II

The eleventh gas is phosphine which occurs in fertilizer fires or in connection with fumigation agents. In these cases an additional measurement is performed with the



2-2350-92
Measuring with the
Dräger Simultaneous Test-Set

Dräger-Tube Phosphine 0.01/a.

Although Dräger Simultaneous Test-Sets I and II were developed to provide measurements in the immediate area of a fire (either during the fire or during the clean-up), they are also very useful to assess the spread of the combustion and decomposition gases to other areas.

Measurement of organic vapors

Solvents and other organic vapors can be involved e. g. during hazardous accidents. For such cases the Simultaneous Test-Set III for organic vapors was developed. Ketones, aromatics, alcohols, aliphatics, and chlorinated hydrocarbons can be indicated with this set.

Measurement strategy

Dräger-Tubes are suitable for obtaining quick assistance when determining certain dangers due to gases on dumpsites for hazardous waste or after accidents, during fires etc. A statistical analysis of such events in which the individual toxic substances could be identified revealed that in 60 to 65 % of all cases combustible substances were present and there was therefore danger of explosion. For this reason principally the danger of explosion should be determined before using the Dräger-Tubes, preferably combined with measurement of the oxygen and carbon monoxide levels. The Dräger X-am product family (Dräger X-am 2500 to Dräger X-am 7000) for example, may be used, being equipment with catalytic or electrochemical sensors.

The Dräger Simultaneous Test Sets were developed so as to obtain information concerning health hazards by rapid measurements in the immediate vicinity.

Apart from registering individual substances, they are also designed to record groups of substances, since the reaction systems they use are deliberately chosen to be non-specific. In certain circumstances information about acidic substances may, for example, be sufficient to be obtain a more detailed characterisation.

In addition to the measurements using the Dräger Simultaneous Test Sets, which are meant to offer quick assistance in decision-making when determining dangers due to gas, the full range of classical Dräger-Tubes is available for measuring more precisely. When necessary, samples can be taken on site, to be analysed subsequently in the laboratory.

The combination of the Dräger X-am family and the Dräger Simultaneous Test Sets I, II and III complement one another. Together they constitute a recommended strategy. In practical situations, this suggested strategy forms the basis for the action to be taken in over 85% of cases. The results of the measurements hold only for the place and the time at which the measurement is taken (momentary concentrations). Specific circumstances that differ from case to case, may call for other special strategies.



The proposed strategy refers to the substances or groups of substances listed in the table. The proposed strategy may not be complete. For other substances or groups of substances which might be present, it may be necessary to carry out further measurements using other methods. The above mentioned measuring ranges are valid for 20°C and 1013 hPa.

Portable Instruments Dräger X-am 27000500	Proposed Strategy for the Determination of Gas Hazards (Warning against Explosion Hazards and Lack or Surplus of Oxygen)	
Simultaneous Test-Set Conductive Compounds 1. Scale Mark 1. Carbon monoxide 33 ppm 2. Hydrocyanic acid 3.5 ppm 3. Hydrochloric acid 11 ppm 4. Nitrous gases 8.2 ppm 5. Formaldehyde 1 ppm	Further Measurements using CMS Analyzer und Chips Carbon monoxide 5 – 150 ppm Hydrocyanic acid 2 – 50 ppm Hydrochloric acid 1 – 25 ppm Nitrogen dioxide 0.5 – 25 ppm Formaldehyde 0.2 – 5 ppm	Further Measurements using Dräger X-act 5000 or accuro and Dräger-Tubes Carbon monoxide 10/b 10 – 3000 ppm Hydrocyanic acid 0.5/a 0.5 – 50 ppm Hydrochloric / Nitric acid 1/a 1 – 15 ppm Nitrous Fumes 2/a 2 – 100 ppm Formaldehyde 0.2/a 0.2 – 5 ppm
Simultaneous Test-Set I for Inorganic Fumes 1. Scale Mark 2. Scale Mark 1. Acid gas 5 ppm 25 ppm 2. Hydrocyanic acid 10 ppm 50 ppm 3. Carbon monoxide 30 ppm 150 ppm 4. Basic gas 50 ppm 250 ppm 5. Nitrous gas 5 ppm 25 ppm	Hydrochloric Acid 1 – 25 ppm Hydrocyanic acid 2 – 50 ppm Carbon monoxide 5 – 150 ppm Ammonia 10 – 150 ppm Nitrogen dioxide 0.5 – 25 ppm	Hydrochloric / Nitric acid 1/a 1 – 15 ppm Hydrocyanic acid 0.5/a 0.5 – 50 ppm Carbon monoxide 10/b 10 – 3000 ppm Ammonia 5/a 5 – 600 ppm Nitrous Fumes 2/a 2 – 100 ppm
Simultaneous Test-Set II for Inorganic Fumes 1. Scale Mark 2. Scale Mark 1. Sulfur dioxide – 10 ppm 2. Chlorine – 2.5 ppm 3. Hydrogen sulfide 10 ppm 50 ppm 4. Phosphine – 0.3 ppm 5. Phosgene – 0.5 ppm	Sulfur dioxide 0.4 – 10 ppm Chlorine 0.2 – 10 ppm Hydrogen sulfide 2 – 50 ppm Phosphine 0.1 – 2.5 ppm Phosgene 0.05 – 2 ppm	Sulfur dioxide 1/a 1 – 25 ppm Chlorine 0.2/a 0.2 – 30 ppm Hydrogen sulfide 1/c 1 – 200 ppm Phosphine 0.01/a 0.01 – 1 ppm Phosgene 0.25 0.25 – 15 ppm
Simultaneous Test-Set III for organic Vapors 1. Scale Mark 2. Scale Mark 1. Ketones 1000 ppm 5000 ppm 2. Aromatics 100 ppm 500 ppm 3. Alcohols 200 ppm 1000 ppm 4. Aliphatics 50 ppm 100 ppm 5. Chlorinated hydrocarbons 50 ppm 100 ppm	Acetone 40 – 600 ppm Benzene 0.2 – 10 ppm Ethanol (Alcohol) 100 – 2500 ppm Petroleum Hydrocarbons 20 – 500 ppm Perchloroethylene 5 – 500 ppm	Acetone 100/b 100 – 12000 ppm Toluene 100/a 10 – 1800 ppm Alcohol 25/a 25 – 5000 ppm Hexane 100/a 100 – 3000 ppm Perchloroethylene 10/b 1 – 500 ppm

Portable Instruments
 Dräger X-am 2500 / 7000
 (Warning against Explosion
 Hazards and Lack or Surplus
 of Oxygen)

**Proposed Strategy for the Investigation
 of Substances using Dräger-Tubes®**

Detection of different Organic and some Inorganic Substances

Polytest

Acetone Acetylene Arsine	Gasoline (Fuel, (Petroleum) Benzene Ethylene	Liquefied Petroleum Gases (Propane, Butane) Carbon Monoxide, Mono Styrene	Perchloroethylene Carbon Disulphide Hydrogen Sulfide	Natural Gas (with more than 2 Vol.-% CO) Nitrogen Monoxide (NO) Toluene, Xylene, Trichloroethylene
--------------------------------	---	--	--	--

positive

Detection of different Organic Substances

Ethyl Acetate 200/a

Ester from Acetic Acid, Alcohols, Ketones, Benzene,
 Toluene, Petroleum Hydrocarbons

positive

**Detection of some
 Halogenated
 Hydrocarbons**

Perchloroethylene 2/a

Perchloroethylene, Chloro-
 form, Dichloroethylene,
 Dichloroethane, Dichloro-
 propene, Trichloroethylene
 Methyl Bromide

negative

**Detection
 of Amine**

Amine Test

Triethylamine UN-Nr.: 1296,
 Ethylenediamine, Hydrazine,
 Ammonia

positive

**Detection of impor-
 tant Aromatic
 Hydrocarbons:**

Toluene 5/b

Benzene UN-Nr.: 1114,
 (Ethyl Benzene, Toluene and
 Xylene discolored the pre-
 layer in lower concentration)

**Detection of
 Ketones:**

Acetone 100/b

Acetone UN-Nr.: 1090
 Methyl Isobutyl Ketone,
 2-Butanone

**Detection of
 Alcohols:**

Alcohol 100/a

Alcohol UN-Nr.: 1096
 Butanol, Methanol, Propanol

negative

**Detection of
 Propane Butane:**

Hydrocarbon
 0.1 %/c

Propane UN-Nr. 1978

Detection of CO:

Carbon Monoxide 10/b

CO UN-Nr. 1016

Further Detection

of other substances if
 necessary

positive

**Detection of
 Phosgene:**

Phosgene 0.25/a

Phosgene

**Detection of Acid
 Reacting
 Substances:**

Acid Test

Hydrochloric Acid
 UN-Nr. 1789,
 HNO₃, Cl₂, NO₂, SO₂

Further Detection

of Methane, Ethane, H₂,
 CO₂ and of other
 substances if necessary

ST-1234-2008



This proposed measurement strategy refers to the substances or groups of substances listed in the strategy. The strategy may not be complete. For other substances or groups of substances which may be present, it may be necessary to carry out further measurements using other methods. The Dräger-Tubes shall only be used with a Dräger-Tube Pump.

2.11 Measurement of Fumigants

In order to prevent damage through animals such as insects and other disease carriers, or to disinfect and sterilize spaces, enclosed spaces are flooded with poisonous or asphyxiant gases.

In present times, with increased demand and a global transport system, many different applications exist for fumigants:

- fumigation of storage areas for foodstuffs,
- fumigation of granaries and grain cargo ships,
- fumigation of containers with all types of goods, during transport,
- fumigation in medical field, for sterilization and disinfection,
- fumigation of buildings or parts of buildings (e.g. houses, apartments, churches, museums, etc.).

Different fumigants or other substances are used, depending on the application area. For example, ethylene oxide and formaldehyde are used for sterilization and disinfection in medical areas. In addition, ammonia is used as an additive for neutralization.

In order to protect agricultural products like grain, vegetables, fruit, nuts, tobacco, etc., phosphine is used to poison insects. Inert gases, such as nitrogen, carbon dioxide and noble gases (primarily argon) are used to displace oxygen and suffocate insects.

Methyl bromide, sulfuryl fluoride and hydrocyanic acid are used to fumigate furniture, wooden products, electrical devices, etc. during transport, and to fumigate buildings and rooms.

It has also been possible to determine such adventurous procedures as the impregnation of leather goods with benzene. Benzene was used by senders when transporting goods in containers, in order to avoid the possible build up of mold on the leather due to air humidity and high temperatures.

Fumigants are used in tablet form. They are then placed in the rooms or containers. They are distributed equally around the entire room in order to achieve the desired level of efficiency. Sometimes, however, they are just placed in one position, such as directly behind the door of a container or on the opposite side of the container to the door. This is particularly dangerous, as it can result in a sudden cloud of fumigant when the container door is opened or when unloading goods.

The concentration of the fumigants used must be measured in order to protect persons present at the start and finish of the fumigation procedure when loading and unloading fumigated products from transport containers, or in case of possible leakages.

This is simple if the fumigants used are known. The range of Dräger-Tubes means that the appropriate tubes or Dräger-Chips can be used, according to the substance and measurement area. However, whenever the fumigant is not known, it is also not clear which Dräger-Tube should be used for the measurement. This question often arises in the field of container transport, where it can be triggered by a missing label of the fumigant used, or a complete lack of reference to fumigation.

Fumigants are highly toxic and can be harmful to health in many other ways. For this reason, suitable measuring instruments should generally be used to check which fumigant has been used (if any) before opening a container. Do not forget to measure the oxygen concentration. Gases used displace the air, including atmospheric oxygen, resulting in a perilous risk of suffocation due to lack of oxygen. This kind of lack of oxygen can be caused relatively easily by leakages in individual packages in the container.

Here is a short overview of regularly used substances, to give you an impression of how dangerous fumigants can be:

- **Carbon dioxide**

Colorless, odor-free, non-combustible gas. It is heavier than air, meaning it can displace atmospheric oxygen in poorly ventilated spaces and form CO₂ reservoirs: risk of suffocation.

- **Phosphine**

Colorless, odor-free gas, highly poisonous, highly flammable.

- **Methyl bromide**

Colorless gas, smells slightly of chloroform, poisonous, carcinogenic.

- **Sulfuryl fluoride**

Colorless, odor-free gas, virtually inert, heavier than air, poisonous, non-combustible.

- **Hydrocyanic acid**

Colorless liquid with typical smell of bitter almond, boiling point 26 °C, highly poisonous, highly explosive when mixed with air.

- **Ethylene oxide**

Colorless, sweet smelling gas, heavier than air, poisonous, carcinogenic, highly flammable.

- **Formaldehyde**

Colorless, pungent smelling gas, poisonous.

- **Ammonia**

Pungent smelling, colorless gas, corrodes and chokes, poisonous, forms explosive mixture with air.

Performing measurements

If the fumigant is known, the corresponding Dräger-Tube is selected and the measurement is executed. Depending on the concentration determined, the room can then be entered or the container opened. If the measured concentration is too high, it is ventilated and a new measurement is taken in order to be able to release the room or container. The measurement of fumigants in containers should only take place when the container is still closed. To do this, the Dräger probe (Order No.: 83 17 188) is inserted through the rubber seal of the container door. In doing this, the Dräger probe causes the rubber seal of the container door to bulge at its lowest point, and the probe is pushed as far as possible into the container. The Dräger-Tubes are prepared for the measurement, and are connected to the probe. The pump strokes required for the measurement are then executed using the Dräger-Tube pump.



ST-4324-2003

Measurement in front of the container door

If the fumigant used is not known, we recommend using the Simultaneous Test-Sets for fumigation to determine which fumigant was used. The Simultaneous Test-Sets allow you to measure five fumigants at the same time:

- Ammonia
- Methyl bromide
- Hydrocyanic acid
- Phosphine
- Formaldehyde
- or ethylene oxide instead of ammonia



ST-4324-2003

Measurement using the probe

If the Simultaneous Test-Set displays one or more gases, the container is ventilated with air before being entered, and the concentrations of the corresponding gases are then tested again with individual tubes.

In addition, the following Dräger-Tubes are used for measuring sulfuryl fluoride, ethylene oxide and carbon dioxide:

Sulfuryl fluoride	1/a	measurement range	1 to 5 ppm
Ethylene oxide	1/a	measurement range	1 to 15 ppm
Carbon dioxide	0.1%/a	measurement range	0.1 to 6 Vol.-%

We recommend using the Dräger Pac 7000 with an electro-chemical sensor for measuring oxygen (measuring range 0 – 25 Vol.-%). It is particularly small and handy.

If the concentration of carbon dioxide is to be measured at the same time, the Dräger X-am 7000 can be used, as this has an IR-CO₂ sensor (measurement range 0 – 5 or 0 – 100 Vol.-%). This is the best sensor for this type of CO₂ measurement. In this measuring device an electro-chemical sensor (measuring range 0 – 25 Vol.-%) is used to measure oxygen.

Whenever a measurement is to be taken to determine risk of explosion, note that catalytic ex-sensors in an inert atmosphere (e. g. caused by the leakage of inert gases) do not work. You need atmospheric oxygen for the measurement. In this case, the Dräger X-am 7000 should be used with an infrared ex-sensor.

2.12 Determination of Volatile Contaminants in Liquid Samples

The Dräger Liquid Extraction method (DLE) is used for the determination of volatile contaminants in water. The measurement basically consists of two steps:

- the extraction of the contaminant
- the measurement of the contaminant

During the extraction process, the contaminant in the water sample is transferred from the liquid phase into the gas phase. A 200 ml sample of water is poured into a specially calibrated gas washing bottle. The Dräger-Tube is attached to the outlet of the bottle and a specific volume of air is drawn through the water sample. The porous frit in the bottle produces a high number of small air bubbles in the water which extract the contaminant as they break at the surface. The extracted contaminant is measured from the headspace of the bottle in the Dräger-Tube. To avoid the interference of the result by contaminants of the air a carbon pre-tube must be installed in front of the gas washing bottle.

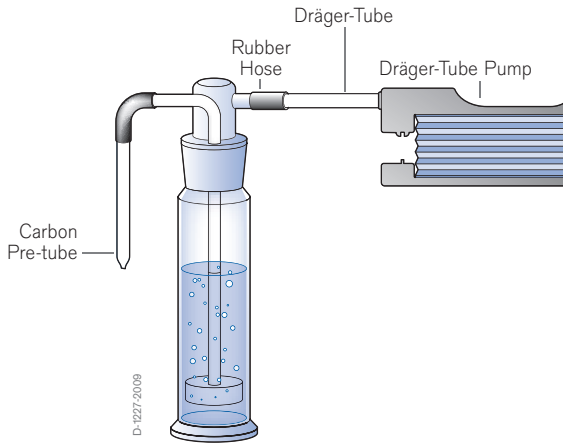

Measurement system of the Dräger Liquid Extraction method

Since the measurement process is a function of a number of substance and device specific parameters, the measurement result has to be calculated by including various constants. The calibration constant A is a rate for the extraction efficiency of the gas washing bottle and is given on the bottle and the bottle insert. The system constants B and C are a function of the sample temperature, the extraction volume, and the substance specific parameters. The B and C constants are given in the special DLE instructions published by Dräger. The calculation of the contaminant concentration Y is done with a linear equation, in which the colorimetric indication X read off the Dräger-Tube is usually given in ppm. The contaminant concentration e. g. in a water sample can be calculated by:

$$Y_{[\text{mg/L}]} = A \cdot B \cdot (X_{[\text{ppm}]} + C)$$

2.13 Detection of Air Flows

In some areas the detection of air currents is of particular importance. Slight air currents must become visible to estimate their source, direction and speed. This is necessary e. g.:

- **in mining**
for the monitoring of firedamp in inaccessible places;
- **in the industry**
for detection of leaks in pipelines, of air currents in rooms or for combustion plants and in laboratory stacks;
- **in the ventilation technique**
for control and setting up of air conditioning plants



Dräger air flow tester

Z-542-93

In addition to this measurement of the air currents are also helpful when estimating e. g. the distribution of toxic substances at workplaces. The knowledge of the air flow pattern permits objective selection of the right measuring points for any air analysis.

With this aim in view Dräger developed an air flow tester. This Dräger-Tube consists of a porous carrier impregnated with fuming sulfuric acid. After opening the tube tips the air is pumped through the tube with the help of a rubber bulb. The white smoke emerging from the tube is carried along by the air flow and makes its direction visible. The air flow tester can be used repeatedly until the smoke is finally exhausted. If the test is completed before the tube is exhausted, the tube should be sealed with the rubber caps provided.

Dräger Flow Check

The Dräger Flow Check air current indicator produces a harmless cloud of smoke that floats freely and easily, because it has the same density as ambient air. Consequently, slight air currents become visible.

The Dräger Flow Check consists of:

- **an instrument for the production of the clouds**
- **an ampoule containing smoke-generating fluid**

The ampoule contains a fluid that is a special mixture of alcohols developed at Dräger. A small heating element in the head of the instrument heats the fluid which condenses on contact with the ambient air. The temperature of the heating element and the quantity of the fluid is electrically balanced.

The Dräger Flow Check incorporates ergonomic form, low weight, and optimal operation into the instrument design. The instrument will generate clouds in any orientation.



ST-61-98

Small, single clouds can be generated with a short press of a button. If a continuous production of clouds is desired, the button can be held or locked in the "on" position. The fluid ampoule is located in a compartment in the handle of the instrument and can be inserted effortlessly into position. The amount of fluid contained in the ampoule is enough to generate approximately five minutes.

Power is supplied by a battery located in the handle of the instrument and can be charged while inside the instrument or separately. A quickcharge option is also possible with the charger. An adapter cable can be used to charge the device from a car mounted cigarette lighter.



ST-64-98

Dräger Flow Check

2.14 Dräger-Measurement-Systems for Long-term Measurements

The Dräger diffusion tubes are direct reading systems used for the determination of time weighted average concentrations over the duration of one to eight hours. Since these are passive measurement systems, relying on the diffusion of contaminant molecules in air, they do not require a pump. The diffusion tubes are used with a plastic holder which is attached to the clothing (shirt collar, pocket, etc.).

The scale printed on the diffusion tube represents the product of the concentration and exposure time given e. g. as ppm x h, ppm x min, Vol.-% x h or mg/L x h. To determine the average concentration of the contaminant, the scale reading is divided by the exposure time (i. e. sampling time) according to the following:



ST-1350-2004

Dräger-Diffusion-Tubes with direct indication

$$c = \frac{\text{indication in ppm} \cdot \text{h}}{\text{time in h}} \quad [\text{ppm}]$$

2.15 Expiration Date, Storage, and Disposal of Dräger-Tubes

Each Dräger-Tube contains a reagent system designed to undergo a chemical reaction with a particular substance. Since chemicals and chemical reagents are not stable indefinitely, each box of Dräger-Tubes is stamped with an expiration date. The tubes are suitable for use through the last day of the month of expiration. Tubes used beyond the expiration date cannot be relied upon to give accurate results.

For the accuracy of the tube indication, throughout the shelf life, Dräger-Tubes should be stored in the original package at room temperature. A note on the package indicates a maximum storage temperature of 25 °C (i. e. 77 °F). Avoid excessively low (less than 35 °F) or high (greater than 77 °F) temperatures during storage and do not subject the tubes to light for prolonged periods.

Do not dispose of used or expired Dräger-Tubes in domestic waste. Dräger-Tubes must be disposed of properly, since the reagent system of the tube contains chemicals, even though the chemicals are present in extremely small amounts. The storage or disposal of chemicals must be conducted according to local, state and federal regulations. Detector tubes are comprised primarily of glass and chemicals. Keep detector Tubes and all chemicals out of the reach of Children.

2.16 Dräger-Sampling-Systems

Monitoring hazardous substances in the air by means of measurements often requires a considerable expenditure with regard to the instrumentation and personnel. This is particularly true when the measurements are done on site and there is no direct reading Dräger-Tube available for the particular application. Under these conditions, a sample must be taken using a suitable collection device and sent to a laboratory for analysis.

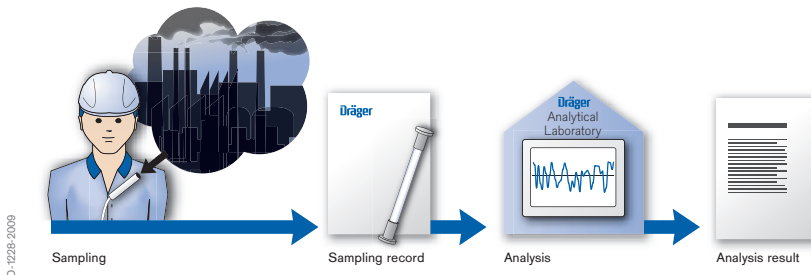

Air investigations at the workplace by sampling on site followed by laboratory analysis.

Using the Dräger sampling system, hazardous substances in the air are collected using a suitable medium via adsorption or chemisorption. The sample is then analysed in the laboratory by means of various analytical methods like gas chromatography (GC), high performance liquid chromatography (HPLC), UV-VIS photometry, or IR spectroscopy.

In the case of a stationary measurement the sampling system is placed at the chosen measurement site for the duration of sampling. When performing personal air monitoring the sampling system is attached to the clothing of the person as close as possible to the inhalation area.

Active Sampling

For active sampling the air to be evaluated is drawn through a sampling tube with a pump. The substance to be collected accumulates on the adsorbent.

Taking the contaminant mass (m_i), determined by the laboratory analysis and the air volume (V) drawn through the sampling tube, the concentration (c_i), of the contaminant can easily be calculated:

$$c_i = \frac{m_i}{V} \quad [\text{mg}/\text{m}^3]$$

The sampling tube features a primary adsorption layer and a secondary layer which are analysed separately in the laboratory. This separate analysis determines whether the entire amount of the measured substance was adsorbed. During sampling the measured substance is first adsorbed at the primary adsorption layer. Sometimes the capacity of this layer is not sufficient, and there is break through resulting in additional adsorption at the secondary layer. When this occurs a new sample must be taken because it is not possible to be sure that the entire amount was adsorbed by the two layers (i.e. the secondary layer could also have experienced break through).

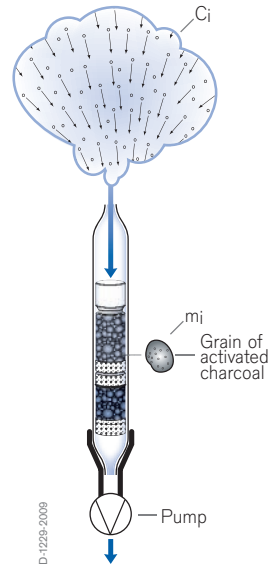

Measurement principle of active sampling with Dräger activated charcoal tubes

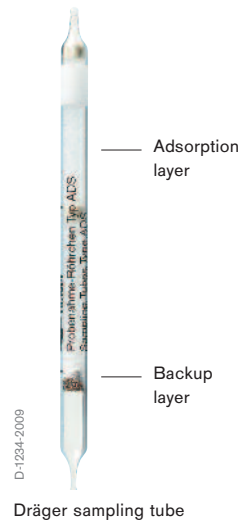

Dräger sampling tube

The air volume to be drawn through the sampling tube is a function of the measured substance and the expected concentration. Usually the volume is between 1 and 20 L.

Since the air volume is used as a reference for the concentration calculation (following the laboratory analysis), the pump has to meet strict criteria. Within the context of the Dräger sampling system the Dräger-Tube pump accuro, or the Dräger X-act 5000 are suitable for short-term measurements.

Sampling tubes for active sampling

Dräger-Tubes	Primary adsorption layer	Backup adsorption layer
Activated Charcoal Type NIOSH coconut shell charcoal	100 mg	50 mg
Activated Charcoal Type B coconut shell charcoal	300 mg	700 mg
Activated Charcoal Type G coconut shell charcoal	750 mg	250 mg
Silica Gel Tube Type NIOSH	140 mg	70 mg
Silica Gel Tube Type B	480 mg	1,100 mg
Silica Gel Tube Type G	1,100 mg	450 mg
Sampling Tube Amines for aliphatic amines and dialkyl sulfates	300 mg	300 mg

Passive Sampling

Passive sampling is performed with diffusion samplers like the Dräger ORSA or the Dräger Nitrous Oxide diffusion samplers. In contrast to active sampling the transport of the contaminant molecules is achieved by diffusion processes and not by using a pump. Contaminant molecules from the ambient air follow a defined diffusion course and are adsorbed by the sorption agent of the diffusion sampler.

Fick's law of diffusion is used for the calculation of the adsorbed substance mass:

$$\Delta c_i = \frac{m_i \cdot L}{D_i \cdot t \cdot A} \text{ [mg/m}^3\text{]}$$

In this context m_i is the substance mass which in the time t diffuses through the sectional area A of the sampler vertically to the concentration grade and Δc_i is the concentration difference along the diffusion course L . Δc_i is basically equivalent to the ambient concentration. The diffusion coefficient D_i is substance specific.

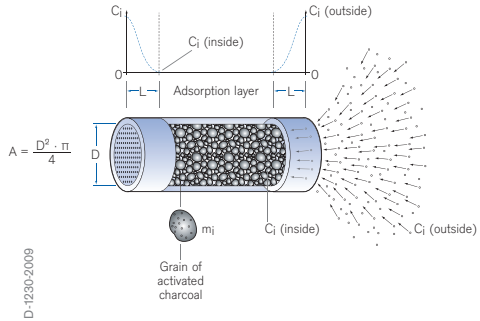

Measurement principle of the Dräger Diffusion sampler ORSA

The diffusion samplers are generally designed to sample over a long period of time for the determination of average concentrations. They are usually used for 1 to 8 hours. In addition the diffusion sampler Dräger ORSA can be used for the investigation of lower concentration ranges over a period of time of up to 168 hours (e.g. for the sampling of perchloroethylene in living spaces).

Sampling tubes for passive monitoring

Diffusion sampler Adsorption layer

Dräger ORSA	400 mg Activated Charcoal from coconut shell charcoal
Nitrous Oxide	400 mg Molecular Sieve

2.17 Measurement of Aldehydes and Isocyanates at the Workplace

Aldehydes are industrially produced in large volumes. They are applied in products of synthetic resin, rubber and adhesives. The different compounds of aldehydes are also found in disinfectants, colors, lacquers and plastics. The most important substances are formaldehyde, glyoxal, glutardialdehyde, acetaldehyde and acrolein.

Isocyanates are of particular interest for industrial applications because they readily react with polyalcohols to form polyurethanes. Polyurethanes are some of the most versatile thermoplastic polymers available. They are recognized for use as coatings because of their hardness, gloss, flexibility and abrasion resistance. As an elastomer they offer good resistance to abrasion, weathering and attack by organic solvents. As a foam they are excellent insulators.

Trying to monitor the occupational exposure limits for isocyanates is very demanding on a measurement method:

- low exposure limit,
- low cross sensitivity for other substances apart from isocyanates,
- sampling should be possible in the inhalation area of an employee,
- less qualified personnel should also be able to perform the sampling.

These requirements are met by two measurement methods which are analogous to using sampling tubes (i. e. sample collection followed by laboratory analysis) the Aldehyde- and Isocyanate-Sampling-Sets. In this case, a pump draws a specific volume of air onto a fiberglass filter treated with specific compounds. This filter is inside a cassette-type sampler. The flowrate specifications are 0.1 to 1 L/min (aldehyde) and 1 to 2 L/min (isocyanates). The sample volume should be 10 to 100 L (aldehydes) and 20 to 100 L (isocyanates).

During the sampling the aldehydes react with a hydrazine compound to form a stable hydrazone derivate. By using the Isocyanate Sampling Set the isocyanates react with an amine to form a stable urea derivate. After sampling, the loaded fiberglass filters must be stored in a cool place. In the laboratory, the fiberglass filters are analysed with high-performance liquid chromatography. To ensure a recovery rate of greater than 95 %, the filter must be analysed immediately.

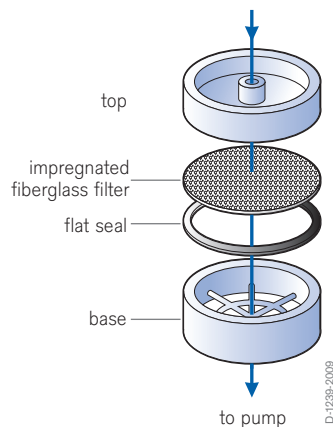

Isocyanate sampler

The detection limits determined by the VDI-Richtlinie 2449 page 1 as absolute units are:

formaldehyde		10 ng
glutardialdehyde		30 ng
toluene diisocyanate	(TDI)	1 ng
diphenylmethane-4,4'-diisocyanate	(MDI)	4 ng
hexamethylene diisocyanate	(HDI)	1 ng

and related to a sampling volume for 20 L:

formaldehyde		0.40 ppb
glutardialdehyde		0.36 ppb
toluene diisocyanate	(TDI)	0.007 ppb
diphenylmethane-4,4'-diisocyanate	(MDI)	0.019 ppb
hexamethylene diisocyanate	(HDI)	0.007 ppb

These methods allows the measurement far below the occupational exposure limits.

2.18 Quality Control for Dräger-Tubes

Dräger-Tubes are normally used for the quantitative determination of contaminants in the air. The need to measure these contaminants may happen on a moments notice. A major advantage of the Dräger-Tube method is its constant state of readiness to provide answers during emergencies or routine monitoring. The extensive quality control program in operation at Dräger Safety AG & Co. KGaA provides the customer of a quality product that can be relied upon time and time again.



D-1242/2009

Dräger-Tube quality control warehouse

The development, production, and testing of Dräger-Tubes is done within the context of the Dräger quality system, an established company standard. This standard contains as a basic document, the Dräger quality handbook and other detailed quality standards as

performance regulations. The quality control system meets international standards. The fact that the Dräger quality system conforms to the requirements of DIN ISO 9001 was confirmed by an independent institute.

Starting with the basic design idea, through all the detailed development stages, to serial production and eventually full production, Dräger builds quality into its Dräger-Tubes.

To verify the performance of Dräger-Tubes, Dräger takes several packages of each production batch and stores them for routine quality tests at regular intervals.

Detector tube standards were established in various countries to ensure the user that the tubes are indicating properly. In the USA for instance, Dräger-Tubes and Dräger-Tube pumps are tested according to NIOSH Method/TCA/A-012, "Certification Requirements for Gas Detector Tube Units" for the Safety Equipment Institute Certification Program. Each manufacturer's detector tubes and gas detector pump(s) are tested as a unit by an independent, third party laboratory accredited by the American Industrial Hygiene Association (AIHA).

3. Dräger-Chip-Measurement-System

3.1 The Philosophy of the Chip-Measurement-System Dräger CMS

The Dräger CMS completes the range of existing measuring methods. It combines the practical needs of the user with the power of intelligent technology. It is one of the most accurate and reliable spot measurement systems currently available for measurement of gas and vapor components. The Dräger CMS represents the new standard in the range of various measurement instruments being used in the market.

The Dräger CMS is characterized by many convincing advantages:

- | | |
|---------------------------------|--|
| Simple Operation | <ul style="list-style-type: none"> - simple commands in backlighted display, - system recognizes the measurement task without user input, - identical procedure for all substances, - one-switch operation, - display text available in multiple languages. |
| Accuracy | <ul style="list-style-type: none"> - mass-flow regulated pump (= compensates for pressure fluctuations), - optical measurement and electronic evaluation, - results displayed in digital read out, - well-known and therefore controllable cross sensitivities. |
| Reliability | <ul style="list-style-type: none"> - automatic system self-test, - calibrated chips, - chip shelf life of up to two years, - robust analyzer. |
| Economical | <ul style="list-style-type: none"> - low training costs, - no calibration of chips necessary, - immediately available for measurement (no waiting for warm-up time), - saves time (quick measurements), - high flexibility. |
| Environmentally friendly | <ul style="list-style-type: none"> - fewer materials used in manufacturing, - least possible chemical reagent, - high recycleability of chips. |

3.2 The Components of the Dräger CMS

The Chip-Measurement-System is a system for the quantitative determination of hazardous gas or vapor concentrations in air. The measurements are carried out in the workplace to monitor for hazardous gas concentrations, process control, and for measurements in confined spaces, etc. This system is designed for short-term measurements. The complete measuring system consists of two main key components:

- Substance-Specific Chips
- Analyzer



The Chip-Measurement-System

The Chip-Measurement-System combines the advantages of five components:

- the chip as capillary array for 10 possible measurements,
- optics for detection of the reaction products,
- the pump system with mass-flow controller to draw in ambient air and ensure a constant air mass-flow,
- mechanics designed to position the chip into the analyzer and to open and test the corresponding capillary in preparation for measuring,
- electronics and software to control and regulate the measuring procedure, to process the signal and of course to provide a digital display of the measured concentrations.

3.3 The Chip

Each chip contains ten measurement capillaries filled with a substance-specific reagent system. Compared to other measurement systems, chemical reagent systems have distinct advantages. One reason for this is, that it is possible to supplement the reacting layer with one or more pre-layers to adsorb moisture, to trap interfering substances, or to convert substances into measurable substances. This supports a substance-specific result of the measurement. Furthermore cross-sensitivities can be analyzed and tested in detail. This detailed knowledge provides a means for controlling and correcting for cross-sensitivities. The reactive preparations necessary for detection are kept in hermetically-sealed glass capillaries until needed. The housing of the chip also protects the capillaries from possible external mechanical or chemical influences.

When the chip is inserted into the analyzer, all information required for detection is transferred to the analyzer by means of a bar code:

- type of gas,
- measuring range,
- measuring time,
- parameters for the calibration function,
- required flow rate.

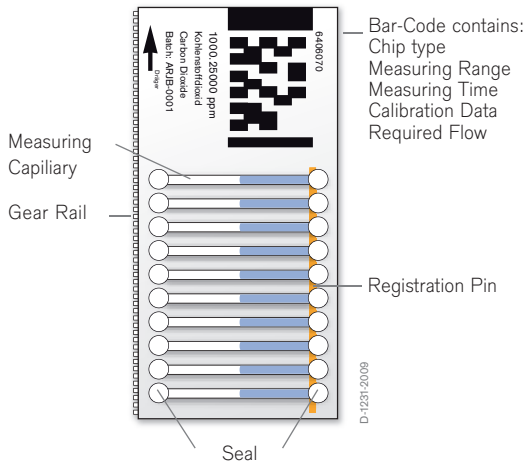

The Chip

The measuring procedure is always the same, so there is no need to remember multiple procedures for different chips. This allows simple and short-time user training and makes working with this new system on a daily basis much easier.

The quantity of reagent used in each capillary is extremely small, resulting in high sensitivity to the measured gas. Furthermore, the use of smaller amounts of active chemicals has a considerable environmental benefit as regards disposal and preparation for re-use - the amount of work involved in this regard has been significantly reduced. The chip housings themselves can be recycled and reused without reprocessing.

3.4 The Analyzer

The analyzer records the measurement effect optoelectronically, thereby eliminating human factors. The gas inlet for the sample air is located at the front of the analyzer and is protected from dust and other impurities. When the integrated mechanics have established an air-tight connection between the entire gas conduction system and the open capillary of the chip, a special pump system pulls a constant mass-flow of air through the capillary.

The pump system consists of a mass-flow-controller, a processor, and a small electric membrane pump. The processor regulates the pump performance for the necessary mass-flow. This combination supports an accurate mass-flow and compensates for fluctuations in the ambient air pressure, within certain limits. No correction of the measurement result is necessary, regardless of whether the measurement is to be carried out at the Dead Sea or in the mountain air of Mexico City.

In the CMS, miniaturization has resulted in a reduction in the sample volume necessary for a measurement. For a typical measurement, only 30 mL of air is needed for a measuring time of approximately two minutes and a mass-flow of 15 mL/min. For shorter measuring times correspondingly less air is needed. This results in a more accurate measurement value which may otherwise be affected by fluctuating concentrations over a longer measurement period.

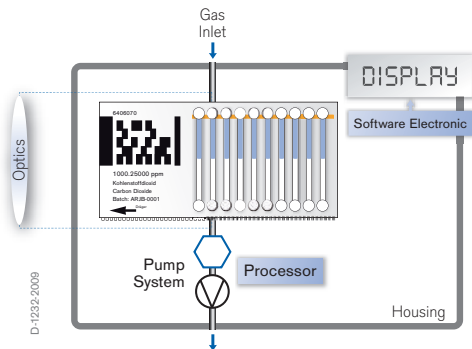

Flow Chart of the Measuring Principle

The capillaries are filled with chemical reagents and filter layers. These ensure a reliable and reproducible response when the corresponding hazardous substance is present, which is one of the main reasons for the high degree of accuracy of the measuring system.

Optoelectronic detectors within the analyzer evaluate the reaction effects in the chip capillary. This has various advantages: small changes in the reaction products can be reliably identified, and measurements can be performed even under conditions of complete darkness, since the measuring signal is electrically processed and indicated in an illuminated display.

The power supply needed for the analyzer to operate is provided by four AA batteries, which have a longer service life than rechargeable batteries on account of their lower self-discharge current.

3.5 The Measurement

The handling of the Dräger CMS is always constant, no matter what gas or vapor is measured. This is provided by simple menu driven commands given by the display as well as the one button/switch operation. The Dräger CMS can be implemented with a minimum of training costs.



Display

The analyzer's most important operating feature is the slide switch positioned symmetrically in the middle. It is symmetrical in order to allow both left and right-handed people to use it with equal ease. The whole measurement is performed using only four switch positions.

Switch Position	Function of the Analyzer
-----------------	--------------------------

0	Device switched off
---	---------------------

1	Switch on analyzer - analyzer immediately performs a complete self-test, followed by the message „function test ok“, displayed for three seconds. Then the message „insert chip“ prompts the user to push the chip selected for the measurement through the rear inlet flap into the analyzer. During this process the analyzer receives information, in the form of a bar code printed on the chip, which is relevant to the measurement: gas type, measuring range, flow and data for the calibration curve.
---	--

The optical system calculates the number of measurements still available on the chip being used, and displays the gas type and the measuring range. Approx. 5 seconds later the user is instructed to set the switch to position 2.

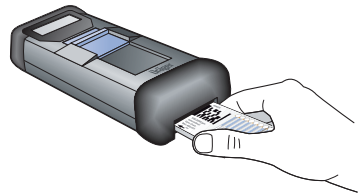

Inserting the chip

ST-1243-2008

2	In this switch position the CMS automatically checks the air-tight integrity of the entire gas conduction system, right up to the chip itself, in order to exclude the occurrence of false measurements due to possible leakages. When the leak test is complete, the switch can be moved to position 3 in order to start the actual measurement process.
---	---

3	Start measurement, both ends of the capillary are open, the pump system pulls ambient air through the measuring capillary of the chips. A bar indicator in the display shows that the measurement is active, until the result of the measurement appears in the display.
---	--

In order to take another test with the same chip, the switch can be moved to position 2 and a new leak test will be conducted.

In order to replace the chip the switch is returned to position 0, the outlet flap opens, the chip is ejected automatically, and the chip can be easily removed.

The Special Feature of Dynamic Dose Measurement

The measurement principle of the CMS is based on a dynamic dose measurement which is dependent on concentration. The basis of this principle is chemical kinetics, whereby the speed of the chemical reaction in the capillary depends on the concentration of the sample. Therefore, the measuring time is not constant, but is directly related to the concentration, i. e. the higher the concentration, the shorter the measuring time. The positioning of the optical unit allows a direct determination of the speed of the chemical reaction within the capillary. Since concentration and reaction speed are directly proportional, the analyzer terminates the measurement very quickly when high concentrations are present.

The safety advantage of the CMS which this provides is of course immediately obvious, as a reduced measuring time at higher concentrations also means a very quick display of the measurement result, thereby providing information about possible gas dangers more quickly. For example, for nitrogen dioxide at a concentration of 5 ppm, there is a standard measuring time of 30 to 35 seconds, whereas for a five-fold value this drops to around 10 to 12 seconds.

3.6 The DataRecorder

The analyzer is equipped with an integrated DataRecorder and a real-time clock. In keeping with the CMS ease-of-use-philosophy, storing measurement results with the DataRecorder is a simple, menu-driven process. Up to 50 measurement results can be stored with the name of the measured substance, the concentration, date and time of the measurement, and a code letter to help identify the measurement location.

3.7 Measurement with the Remote System

Together with the Dräger CMS Analyzer, the Remote System measures various hazardous gases and vapours in inaccessible places such as ducts, shafts or tank systems. The maximum operating time of the analyzer may be reduced by up to 50 %, depending on the operating time of the Remote System.

The Remote System consists of an external pump, which is connected to the Analyzer. It is used together with Dräger extension hoses (length of 3 m or 10 m) or a Dräger telescopic tube (1 m).

Before each measurement, the extension hose or the telescope probe must be flushed with the air sample to be measured. The flushing phase is necessary to minimize or eliminate effects associated with the use of an extension hose (e. g. memory effects, dead volume).

The duration of the flushing phase depends on factors such as:

- type and concentration of the substance to be measured,
- material, length, diameter, and age of the extension hose.

There is no standard flushing time that can be stated that would be valid for all cases. All possible factors affecting the measurement must be considered. Please always refer to the Instructions for Use of the Remote System and the Instructions for Use of the Chips.

The flushing times given in the Instructions for Use have been determined for the specified gas concentrations only. The values refer to the extension hose supplied with the remote System (e. g. length: 3 m, inside diameter: 1.5 m, new, dry, clean) in laboratory conditions.

3.8 Validation of Third Parties

Performance data of each measuring system can be found in the instructions for use. Usually the technical data will be checked by independent institutions. The results will be described from the test organization in a validation report. To date, the Chip-Measurement-System has been tested by the following independent institutions or laboratories:

- Authority for Civil Defence, Germany, Bonn-Bad Godesberg
- Institute of Fire Department Sachsen-Anhalt, Germany, Heyrothsberge
- Clayton Laboratory Services, USA, Detroit
- Austrian Workplace Safety Testing Institute of the Employee's Liability Insurance
- Association, Austria, Vienna

Authority for Civil Defence, Germany

The operation and function of the Dräger CMS were tested. Using the Remote System, measurements against different test gas concentrations were performed. Ten chip-types were checked:

- Ammonia	2	-	50 ppm	- Hydrochloric Acid	20	-	500 ppm
- Ammonia	10	-	150 ppm	- Hydrocyanic Acid	2	-	50 ppm
- Carbon Monoxide	5	-	150 ppm	- Hydrogen Sulfide	2	-	50 ppm
- Chlorine	0.2	-	10 ppm	- Hydrogen Sulfide	20	-	500 ppm
- Hydrochloric Acid	1	-	25 ppm	- Nitrogen Dioxide	0.5	-	25 ppm

The measurement results comply with the performance specifications shown in the instructions for use. The study recommends the Dräger CMS as a robust and easy to use instrument.

Institute of Firedepartment Sachsen Anhalt, Germany

During this study measurements of fires were made in the laboratory and under actual fire-fighting conditions. Based on the results of this study, the institute recommends the Chip-Measurement-System for the measurement of hazardous gases and vapors.

Clayton Laboratory Services, USA

The Dräger CMS was tested using benzene at two concentrations (1 ppm and 4 ppm). The accuracy and reproducibility of the measuring system was within the values given in the instructions for use.

Measuring results	Clayton Laboratory		Dräger Laboratory		Instructions for use
	1 ppm	4 ppm	1 ppm	4 ppm	
Concentration	1 ppm	4 ppm	1 ppm	4 ppm	0.2 - 10 ppm
Accuracy	± 4.4%	± 7.3%	- 1 %	5 %	± 18 %
Reproducibility	± 9.9%	± 8.2%	15 %	11 %	± 25 %

Chip: Benzene 0.2-10 ppm

Order-Code: 64 06 030

Batch-No.: ARLM-0611

Austrian Workplace Safety Testing Institute of the Employee's Liability Insurance Association, Austria

The intention of the study was a practice-oriented test of the Dräger CMS in varying conditions of temperature, humidity, and concentration. The measuring results of the Dräger CMS measurements were compared with reference methods.

Different chip-types were checked in a brewery and a thermal spring / bath:

- Carbon Dioxide 1,000 to 25,000 ppm
- Carbon Dioxide 1 to 20 Vol.-%
- Hydrogen Sulfide 2 to 50 ppm

The basis of this validation was the Austrian standard EN 482: "Workplace Atmospheres – General Requirements for Methods of Measuring Chemical Agents".

The institute confirms:

- The measuring results of the Dräger CMS correspond with the results of the reference methods.
- The accuracy of the Dräger CMS is far higher than the required accuracy of the standard EN 482.
- The Dräger CMS is a suitable measurement system.

3.9 Performance Data of the Dräger CMS

Measuring Range	depends on the chip type
Typical Measuring Time	20 seconds to 3 minutes (depends on the chip type and the concentration of hazardous gas to be measured) 20 seconds to 10 minutes with special hazardous gas
Calibration	by manufacturer
Temperature (operation)	0 to 40 °C (32 to 104 °F)
Temperature (storage)	- 20 to 60 °C (- 4 to 140 °F) (Analyzer) < 25 °C (< 77 °F) (Chips)
Atmospheric Pressure	700 to 1,100 hPa
Relative Humidity	0 to 95 %, not condensing
System Diagnosis	automatic self-diagnosis, microprocessor controlled for all components of the system
Display	LCD, alphanumerical digits, backlight
Menu Languages	English, German, French, Spanish
Operational Time	approx. 450 minutes of measurements (per battery pack)
Power Supply	4 x 1.5-V-batteries, only use the following types: Ralsten (Energizer) Alkaline LR6 Duracell MN 1500 LR6 Rayovac Rechargeable Alkaline AA (only to use with Rayovac Charger PS1 or PS3)
Weight	730 g (1.6 lbs., analyzer with batteries)
Dimensions	215 x 105 x 65 mm; 8.5" x 4.1" x 2.5" (L x W x H)
Electromagnetic Interference EMV	EN 550 11; by 10/01 EN 502 70
Radio Frequency Interference RFI	EN 550 14
Ingress Protection	IP 54

3.10 Approvals

Approvals / Certifications for Analyzer Set (Order code 64 05 300):

ATEX,

BVS 03 ATEX E 209 X

UL USA,

Class 1, Div 1, Groups A, B, C, D, Temp. Code T4, 2P911

UL Canada,

Class 1, Div 1, Groups A, B, C, D, Temp. Code T4, 2P911

CSA Canada,

Class 1, Div 1, Groups A, B, C, D, Ex ia Temp. Code T4

4. Overview of the Dräger-Tubes and Chip-Measurement-System

4.1 Dräger-Tube Pumps and Systems

Dräger-Tube pump accuro with Dräger-Tube opener TO 7000	64 00 000
Dräger-Tube pump set accuro	64 00 260
Extension hose Dräger accuro & Dräger X-act 5000, 1 m	64 00 561
Extension hose Dräger accuro & Dräger X-act 5000, 3 m	64 00 077
Extension hose Dräger accuro & Dräger X-act 5000, 10 m	64 00 078
Extension hose Dräger accuro & Dräger X-act 5000, 15 m	64 00 079
Extension hose Dräger X-act 5000, 30 m	64 00 175
Dräger accuro spare parts set	64 00 220
Dräger X-act 5000	45 23 500
Alkalinebattery pack w/o battery	45 23 525
Alkalinebattery, 6 pc. needed	81 03 594
NiMhy Battery, T4	45 23 520
Wall-Wart Charger 100-240 Vac	45 23 545
Car Charger 12/24V	45 23 511
SO ₃ Filter Replacement	81 03 525
Case, orange, without contents	83 17 147
Hot air probe	CH 00 213
Vehicle exhaust probe	CH 00 214
Probe 400	83 17 188
Dräger-Tube opener TO 7000	64 01 200
Adapter for NIOSH sampling tubes	67 28 639
DLE-Set Dräger Liquid Extraction set	64 00 030
Dräger Aerotest for measurement of air, medical gases and carbon dioxide:	
Dräger Aerotest 5000	64 01 220
Dräger Aerotest Alpha, complete	65 27 150
Dräger MultiTest med. Int, complete	65 20 260
Dräger Simultaneoustest CO ₂ , complete	65 26 170
Dräger Aerotest Simultaneous HP, complete	65 25 951
Dräger Aerotest Navy, complete	65 25 970
Impactor for measurement of oil mist in compressed air	81 03 560
Adapter for Dräger Oil-Impactor	81 03 557

4.2 Dräger-Tubes for Short-Term Measurements

Dräger-Tubes	Order Code	Standard Range of Measurement [20 °C, 1013 hPa]	Measurement Time [min]	Page
Acetaldehyde 100/a	67 26 665	100 to 1000 ppm	5	100
Acetic Acid 5/a	67 22 101	5 to 80 ppm	30 s	101
Acetone 40/a	81 03 381	40 to 800 ppm	1	102
Acetone 100/b	CH 22 901	100 to 12000 ppm	4	103
Acid Test	81 01 121	qualitative	3 s	104
Acrylonitrile 0.5/a (5)	67 28 591	1 to 20 ppm	2	105
		0.5 to 10 ppm	4	
Acrylonitrile 5/b	CH 26 901	5 to 30 ppm	30 s	106
Activation tube for use in conjunction with Formaldehyde 0.2/a tube	81 01 141			
Alcohol 25/a	81 01 631		5	107
Methanol		25 to 5000 ppm		
i-Propanol		50 to 4000 ppm		
n-Butanol		100 to 5000 ppm		
Ethanol		25 to 2000 ppm		
Alcohol 100/a	CH 29 701	100 to 3000 ppm	1.5	108
Amine Test	81 01 061	qualitative	5 s	109
Ammonia 0.25/a	81 01 711	0.25 to 3 ppm	1	110
Ammonia 2/a	67 33 231	2 to 30 ppm	1	111
Ammonia 5/a	CH 20 501	5 to 70 ppm	1	112
		50 to 600 ppm	10 s	
Ammonia 5/b	81 01 941	5 to 100 ppm	10 s	113
Ammonia 0.5%/a	CH 31 901	0.5 to 10 Vol%	20 s	114
Aniline 0.5/a	67 33 171	0.5 to 10 ppm	4	115
Aniline 5/a	CH 20 401	1 to 20 ppm	3	116
Arsine 0.05/a	CH 25 001	0.05 to 3 ppm	6	117
Benzene 0.25/a	81 03 691	0.25 to 2 ppm	5	118
		2 to 10 ppm	1	
Benzene 1/a	81 03 641	1 ppm Benzene	3	119
Benzene 2/a (5)	81 01 231	2 to 60 ppm	8	120
Benzene 5/a	67 18 801	5 to 40 ppm	3	121
Benzene 5/b	67 28 071	5 to 50 ppm	8	122
Benzene 15/a	81 01 741	15 to 420 ppm	4	123
Carbon Dioxide 100/a	81 01 811	100 to 3000 ppm	4	124

Dräger-Tubes	Order Code	Standard Range of Measurement [20 °C, 1013 hPa]	Measurement Time [min]	Page
Carbon Dioxide 0.1%/a	CH 23 501	0.5 to 6 Vol% 0.1 to 1.2 Vol%	30 s 2.5	125
Carbon Dioxide 0.5%/a	CH 31 401	0.5 to 10 Vol%	30 s	126
Carbon Dioxide 1%/a	CH 25 101	1 to 20 Vol%	30 s	127
Carbon Dioxide 5%/A	CH 20 301	5 to 60 Vol%	2	128
Carbon Disulfide 3/a	81 01 891	3 to 95 ppm	2	129
Carbon Disulfide 5/a	67 28 351	5 to 60 ppm	3	130
Carbon Disulfide 30/a	CH 23 201	0.1 to 10 mg/L	1	131
Carbon Monoxide 2/a	67 33 051	2 to 60 ppm	4	132
Carbon Monoxide 5/c	CH 25 601	100 to 700 ppm 5 to 150 ppm	30 s 150 s	133
Carbon Monoxide 8/a	CH 19 701	8 to 150 ppm	2	134
Carbon Monoxide 10/b	CH 20 601	100 to 3000 ppm 10 to 300 ppm	20 s 4	135
Carbon Monoxide 0.3%/b	CH 29 901	0.3 to 7 Vol%	30 s	136
Carbon Tetrachloride 0.1/a	81 03 501	0.1 to 5 ppm	2.5	137
Carbon Tetrachloride 1/a	81 01 021	1 to 15 ppm 10 to 50 ppm	6 3	138
Chlorine 0.2/a	CH 24 301	0.2 to 3 ppm 3 to 30 ppm	3 30 s	139
Chlorine 0.3/b	67 28 411	0.3 to 5 ppm	8	140
Chlorine 50/a	CH 20 701	50 to 500 ppm	20 s	141
Chlorine Dioxide 0.025/a	81 03 491	0.025 to 1 ppm 0.1 to 1 ppm	7.5 2.5	142
Chlorobenzene 5/a (5)	67 28 761	5 to 200 ppm	3	143
Chloroform 2/a (5)	67 28 861	2 to 10 ppm	9	144
Chloroformate 0.2/b	67 18 601	0.2 to 10 ppm	3	145
Chloropicrine 0.1/a	81 03 421	0.1 to 2 ppm	7.5	146
Chloroprene 5/a	67 18 901	5 to 60 ppm	3	147
Chromic Acid 0.1/a (9)	67 28 681	0.1 to 0.5 mg/m ³	8	148
Cyanide 2/a	67 28 791	2 to 15 mg/m ³	2.5	149
Cyanogen Chloride 0.25/a	CH 19 801	0.25 to 5 ppm	5	150
Cyclohexane 100/a	67 25 201	100 to 1500 ppm	5	151
Cyclohexylamine 2/a	67 28 931	2 to 30 ppm	4	152
Diesel Fuel	81 03 475	25 to 200 mg/m ³	30 s	153

Dräger-Tubes	Order Code	Standard Range of Measurement [20 °C, 1013 hPa]	Measurement Time [min]	Page
Diethyl Ether 100/a	67 30 501	100 to 4000 ppm	3	154
Dimethyl Formamide 10/b	67 18 501	10 to 40 ppm	3	155
Dimethyl Sulfate 0.005/c (9)	67 18 701	0.005 to 0.05 ppm	50	156
Dimethyl Sulfide 1/a (5)	67 28 451	1 to 15 ppm	15	157
E pichlorhydrin 5/c	67 28 111	5 to 80 ppm	8	158
Ethyl Acetate 200/a	CH 20 201	200 to 3000 ppm	5	159
Ethyl Benzene 30/a	67 28 381	30 to 400 ppm	2	160
Ethyl Formate 20/a	81 03 541	20 to 500 ppm	5	161
Ethyl Glycol Acetate 50/a	67 26 801	50 to 700 ppm	3	162
Ethylene 0.1/a (5)	81 01 331	0.2 to 5 ppm	30	163
Ethylene 50/a	67 28 051	50 to 2500 ppm	6	164
Ethylene Glycol 10 (5)	81 01 351	10 to 180 mg/m ³	7	165
Ethylene Oxide 1/a (5)	67 28 961	1 to 15 ppm	8	166
Ethylene Oxide 25/a	67 28 241	25 to 500 ppm	6	167
F luorine 0.1/a	81 01 491	0.1 to 2 ppm	5	168
Formaldehyde 0.2/a	67 33 081	0.2 to 2.5 ppm	20	
		0.5 to 5 ppm	1.5	169
Activation tube for use in conjunction with Formaldehyde 0.2/a tube	81 01 141			
Formaldehyde 2/a	81 01 751	2 to 40 ppm	30 s	170
Formic Acid 1/a	67 22 701	1 to 15 ppm	3	171
H alogenated Hydrocarbons 100/a (8)	81 01 601	100 to 2600 ppm	1	172
Hexane 100/a	67 28 391	100 to 3000 ppm	3	173
Hydrazine 0.01/a	81 03 351	0.01 to 0.4 ppm	30	174
		0.5 to 6 ppm	1	
Hydrazine 0.25/a	CH 31 801	0.25 to 10 ppm	1	175
		0.1 to 5 ppm	2	
Hydrocarbons 2/a	81 03 581	2 to 24 mg/m ³	5	176
Hydrocarbons 0.1%/c	81 03 571	0.1 to 1.3 Vol.-%Propane		177
		0.1 to 1.3 Vol.-%Butane		
		0.1 to 1.3 Vol.-%mix 1:1		
Hydrochloric Acid 0.2/a	81 03 481	0.2 to 3 ppm	2	178
		3 to 20 ppm	40 s	

Dräger-Tubes	Order Code	Standard Range of Measurement [20 °C, 1013 hPa]	Measurement Time [min]	Page
Hydrochloric Acid 1/a	CH 29 501	1 to 10 ppm	2	179
Hydrochloric Acid 50/a	67 28 181	500 to 5000 ppm	30 s	180
		50 to 500 ppm	4	
Hydrochloric Acid/Nitric Acid 1/a	81 01 681			181
Hydrochloric Acid		1 to 10 ppm	1.5	
Nitric Acid		1 to 15 ppm	3	
Hydrocyanic Acid 0.5/a	81 03 601	0.5 to 5 ppm	2.5	182
		5 to 50 ppm	0.5	
Hydrogen 0.2%/a	81 01 511	0.2 to 2.0 Vol%	1	183
Hydrogen 0.5%/a	CH 30 901	0.5 to 3.0 Vol%	1	184
Hydrogen Fluoride 0.5/a	81 03 251	0.5 to 15 ppm	2	185
		10 to 90 ppm	25 s	
Hydrogen Fluoride 1.5/b	CH 30 301	1.5 to 15 ppm	2	186
Hydrogen Peroxide 0.1/a	81 01 041	0.1 to 3 ppm	3	187
Hydrogen Sulfide 0.2/a	81 01 461	0.2 to 5 ppm	5	188
Hydrogen Sulfide 0.2/b	81 01 991	0.2 to 6 ppm	55 s	189
Hydrogen Sulfide 0.5/a	67 28 041	0.5 to 15 ppm	6	190
Hydrogen Sulfide 1/c	67 19 001	10 to 200 ppm	20 s	191
		1 to 20 ppm	3	
Hydrogen Sulfide 1/d	81 01 831	10 to 200 ppm	1	192
		1 to 20 ppm	10	
Hydrogen Sulfide 2/a	67 28 821	20 to 200 ppm	20 s	193
		2 to 20 ppm	3.5	
Hydrogen Sulfide 2/b	81 01 961	2 to 60 ppm	30 s	194
Hydrogen Sulfide 5/b	CH 29 801	5 to 60 ppm	4	195
Hydrogen Sulfide 100/a	CH 29 101	100 to 2000 ppm	30 s	196
Hydrogen Sulfide 0.2%/A	CH 28 101	0.2 to 7 Vol%	2	197
Hydrogen Sulfide 2%/a	81 01 211	2 to 40 Vol%	1	198
Simultaneous Tube	CH 28 201	0.2 to 7 Vol%	2	199
Hydrogen Sulfide + Sulfur Dioxide 0.2%/A				199
Iodine 0.1/a	81 03 521	1 to 5 ppm	5	200
		0.1 to 0.6 ppm	4	
Mercaptan 0.1/a	81 03 281	0.1 to 2.5 ppm	3	201
		3 to 15 ppm	40 s	

Dräger-Tubes	Order Code	Standard Range of Measurement [20 °C, 1013 hPa]	Measurement Time [min]	Page
Mercaptan 0.5/a	67 28 981	0.5 to 5 ppm	5	202
Mercaptan 20/a	81 01 871	20 to 100 ppm	2.5	203
Mercury Vapour 0.1/b	CH 23 101	0.05 to 2 mg/m ³	10	204
Methyl Acrylate 5/a	67 28 161	5 to 200 ppm	5	205
Methyl Bromide 0,2/a	81 03 391	0.2 to 2 ppm 2 to 8 ppm	8 4	206
Methyl Bromide 0.5/a	81 01 671	5 to 30 ppm 0.5 to 5 ppm	2 5	207
Methyl Bromide 3/a (5)	67 28 211	10 to 100 ppm 3 to 35 ppm	1 2.5	208
Methyl Bromide 5/b	CH 27 301	5 to 50 ppm	1	209
Methylene Chloride 20/a	81 03 591	20 to 200 ppm	7	210
Methylisothiocyanate 0.1/a	81 03 485	0.2 to 6 ppm 0.1 to 1.2 ppm	60 s 200 s	211
Natural Gas Test (5)	CH 20 001	qualitative	100 s	212
Nickel Tetracarbonyl 0.1/a (9)	CH 19 501	0.1 to 1 ppm	5	213
Nitric Acid 1/a	67 28 311	5 to 50 ppm 1 to 15 ppm	2 4	214
Nitrogen Dioxide 0.1/a	81 03 631	5 to 30 ppm 0.1 to 5 ppm	15 s 75 s	215
Nitrogen Dioxide 2/c	67 19 101	5 to 100 ppm 2 to 50 ppm	1 2	216
Nitrous Fumes 0,2/a	81 03 661	0.2 to 6 ppm 5 to 30 ppm	40 s 30 s	217
Nitrous Fumes 2/a	CH 31 001	5 to 100 ppm 2 to 50 ppm	1 2	218
Nitrous Fumes 20/a	67 24 001	20 to 500 ppm	30 s	219
Nitrous Fumes 50/a	81 01 921	250 to 2000 ppm 50 to 1000 ppm	40 s 80 s	220
Nitrous Fumes 100/c	CH 27 701	500 to 5000 ppm 100 to 1000 ppm	1.5 18 s	221
Oil Mist 1/a	67 33 031	1 to 10 mg/m ³	25	222
Olefine 0.05%/a	CH 31 201		5	223
Propylene		0.06 to 3.2 Vol%		
Butylene		0.04 to 2.4 Vol%		
Organic Arsenic Compounds and Arsine	CH 26 303	0.3mg/m ³ as AsH ₃	3	

Dräger-Tubes	Order Code	Standard Range of Measurement [20 °C, 1013 hPa]	Measurement Time [min]	Page
Organic Basic Nitrogen Compounds	CH 25 903	1mg/m ³ threshold value	1.5	
Oxygen 5%/B (8)	67 28 081	5 to 23 Vol%	1	224
Oxygen 5%/C	81 03 261	5 to 23 Vol%	1	225
Ozone 0.05/b	67 33 181	0.05 to 0.7 ppm	3	226
Ozone 10/a	CH 21 001	20 to 300 ppm	20 s	227
Pentane 100/a	67 24 701	100 to 1500 ppm	15 s	228
Perchloroethylene 0.1/a	81 01 551	0.5 to 4 ppm	3	229
		0.1 to 1 ppm	9	
Perchloroethylene 2/a	81 01 501	20 to 300 ppm	30 s	230
		2 to 40 ppm	3	
Perchloroethylene 10/b	CH 30 701	10 to 500 ppm	40 s	231
Petroleum Hydrocarbons 10/a	81 01 691	10 to 300 ppm	1	232
Petroleum Hydrocarbons 100/a	67 30 201	100 to 2500 ppm	30 s	233
Phenol 1/b	81 01 641	1 to 20 ppm	5	234
Phosgene 0.02/a	81 01 521	0.02 to 1 ppm	6	235
		0.02 to 0.6 ppm	12	
Phosgene 0.05/a	CH 19 401	0.04 to 1.5 ppm	11	236
Phosgene 0.25/c	CH 28 301	0.25 to 5 ppm	1	237
Phosphine 0.01/a	81 01 611	0.01 to 0.3 ppm	8	238
		0.1 to 1.0 ppm	2.5	
Phosphine 0.1/c	81 03 711	0.5 to 3 ppm	1	239
		0.1 to 1.0 ppm	2.5	
Phosphine 0.1/b	81 03 341	1 to 15 ppm	20 s	240
in Acetylene		0.1 to 1 ppm	4	
Phosphine 1/a	81 01 801	20 to 100 ppm	2	241
		1 to 20 ppm	10	
Phosphine 25/a	81 01 621	200 to 10000 ppm	1.5	242
		25 to 900 ppm	13	
Phosphine 50/a	CH 21 201	50 to 1000 ppm	2	243
Phosphoric Acid Esters 0.05/a	67 28 461	0.05 ppm Dichlorvos	5	292
Polytest	CH 28 401	qualitative	1.5	244
Pyridine 5/A	67 28 651	5 ppm	20	245
Styrene 10/a	67 23 301	10 to 200 ppm	3	246

Dräger-Tubes	Order Code	Standard Range of Measurement [20 °C, 1013 hPa]	Measurement Time [min]	Page
Styrene 10/b	67 33 141	10 to 250 ppm	3	247
Styrene 50/a	CH 27 601	50 to 400 ppm	2	248
Sulfuryl Fluoride 1/a (5)	81 03 471	1 to 5 ppm	3	249
Sulfur Dioxide 0.1/a	67 27 101	0.1 to 3 ppm	20	250
Sulfur Dioxide 0.5/a	67 28 491	1 to 25 ppm	3	251
		0.5 to 5 ppm	6	
Sulfur Dioxide 1/a	CH 31 701	1 to 25 ppm	3	252
Sulfur Dioxide 20/a	CH 24 201	20 to 200 ppm	3	253
Sulfur Dioxide 50/b	81 01 531	400 to 8000 ppm	15 s	254
		50 to 500 ppm	3	
Sulfuric Acid 1/a (9)	67 28 781	1 to 5 mg/m ³	100	255
Tertiary Butylmercaptan (natural gas odorization)	81 03 071	1 to 10 mg/m ³	5	256
Tetrahydrothiophene 1/b (5)	81 01 341	1 to 10 ppm	10	257
Thioether	CH 25 803	1 mg/m ³ threshold value	1.5	258
Toluene 5/b	81 01 661	50 to 300 ppm	2	259
		5 to 80 ppm	10	
Toluene 50/a	81 01 701	50 to 400 ppm	1.5	260
Toluene 100/a	81 01 731	100 to 1800 ppm	1.5	261
Toluene Diisocyanate 0.02/A (9)	67 24 501	0.02 to 0.2 ppm	20	262
Trichloroethane 50/d (5)	CH 21 101	50 to 600 ppm	2	263
Trichloroethylene 2/a	67 28 541	20 to 250 ppm	1.5	264
		2 to 50 ppm	2.5	
Trichloroethylene 50/a	81 01 881	50 to 500 ppm	1.5	265
Triethylamine 5/a	67 18 401	5 to 60 ppm	2	266
Vinyl Chloride 0.5/b	81 01 721	5 to 30 ppm	30 s	267
		0.5 to 5 ppm	3	
Vinyl Chloride 100/a	CH 19 601	100 to 3000 ppm	4	268
Water Vapor 0.1	CH 23 401	1 to 40 mg/L	2	269
Water Vapor 0.1/a	81 01 321	0.1 to 1.0 mg/L	1.5	270
Water Vapor 1/b	81 01 781	20 to 40 mg/L	20 s	271
		1 to 18 mg/L	40 s	
Xylene 10/a	67 33 161	10 to 400 ppm	1	272

4.3 Dräger-Tubes for Measurements in Liquid Samples

Substance	Measuring Range [1013 hPa]	Dräger-Tubes	Order Code
Inorganic Substances			
Ammonia	1.5 - 10 mg/L	Ammonia 0.25/a	81 01 711
	10 - 100 mg/L	Ammonia 0.25/a	81 01 711
Hydrocyanic Acid	0.5 - 10 mg/L	Hydrocyanic Acid 0.5/a	81 06 601
Hydrogen Sulfide (total sulfide)	50 - 500 µg/L	Hydrogen Sulfide 0,2/a	81 01 461
	0.2 - 1 mg/L	Hydrogen Sulfide 1/c	67 19 001
	0.5 - 10 mg/L	Hydrogen Sulfide 5/b	CH 29 801
Aliphatic hydrocarbons			
Petroleum Hydrocarbons	0.5 - 30 mg/L	Petroleum Hydrocarbons 10/a	81 01 691
Diesel fuels	0.5 - 5 mg/L	Petroleum Hydrocarbons 10/a	81 01 691
Jet fuels	0.5 - 5 mg/L	Petroleum Hydrocarbons 10/a	81 01 691
n-Octane	0.1 - 2 mg/L	Petroleum Hydrocarbons 10/a	81 01 691
	2 - 25 mg/L	Petroleum Hydrocarbons 100/a	67 30 201
Aromatic hydrocarbons			
Benzene	0.5 - 5 mg/L	Benzene 2/a	81 01 231
Toluene	1 - 10 mg/L	Toluene 50/a	81 01 701
Xylene (o, m, p)	0.3 - 10 mg/L	Xylene10/a	67 33 161
BTX-Aromatics	0.2 - 5 mg/L	Toluene 5/b	81 01 161
BTX-Aromatics (soil analysis)	2 - 50 mg/Kg	Toluene 5/b	81 01 161
Halogenated hydrocarbons (volatile)			
Soil analysis	qualitative	Perchloroethylene 0,1/a	81 01 551
	qualitative	Perchloroethylene 2/a	81 01 501
Multiphase system	qualitative	Methyl Bromide 0,5/a	81 01 671
	qualitative	Perchloroethylene 0,1/a	81 01 551
	qualitative	Perchloroethylene 2/a	81 01 501
	qualitative	Trichloroethane 50/d	CH 21 101
Oil muds / -emulsions	qualitative	Methyl Bromide 0,5/a	81 01 671
	qualitative	Perchloroethylene 0,1/a	81 01 551
	qualitative	Perchloroethylene 2/a	81 01 501
	qualitative	Trichloroethane 50/d	CH 21 101

Substance	Measuring Range [1013 hPa]	Dräger-Tubes	Order Code
Chlorinated hydrocarbons (volatile)			
Perchloroethylene	10 - 80 µg/L	Perchloroethylene 0,1/a	81 01 551
	0.1 - 4 mg/L	Perchloroethylene 2/a	81 01 501
1,1,1-Trichloroethane	0.5 - 5 mg/L	Trichloroethane 50/d	CH 21 101
Trichloroethylene	10 - 100 µg/L	Perchloroethylene 0,1/a	81 01 551
	0.1 - 1 mg/L	Perchloroethylene 2/a	81 01 501
	0.2 - 3 mg/L	Trichloroethylene 2/a	67 28 541
Organic acids			
Acetic acid	0.5 - 20 g/L	Acetic acid 5/a	67 22 101
Formic acid	1 - 20 g/L	Acetic acid 5/a	67 22 101
Organic acids (sumparameter)	0.5 - 15 g/L	Acetic acid 5/a	67 22 101
Propionic acid	0.3 - 10 g/L	Acetic acid 5/a	67 22 101

4.4 Dräger-Diffusion-Tubes with Direct Indication

Dräger-Tube	Order Code	Standard Range of Meas. for 1 h [20 °C, 1013 hPa]	Standard Range of Measurement for 8 h [20 °C, 1013 hPa]	Page
Acetic Acid 10/a-D	81 01 071	10 to 200 ppm	1.3 to 25 ppm	352
Ammonia 20/a-D	81 01 301	20 to 1500 ppm	2.5 to 200 ppm	353
Butadiene 10/a-D	81 01 161	10 to 300 ppm	1.3 to 40 ppm	354
Carbon Dioxide 500/a-D	81 01 381	500 to 20000 ppm	65 to 2500 ppm	355
Carbon Dioxide 1%/a-D	81 01 051	1 to 30 Vol%	0.13 to 4 Vol%	356
Carbon Monoxide 50/a-D	67 33 191	50 to 600 ppm	6 to 75 ppm	357
Ethanol 1000/a-D	81 01 151	1000 to 25000 ppm	125 to 3100 ppm	358
Hydrochloric Acid 10/a-D	67 33 111	10 to 200 ppm	1.3 to 25 ppm	359
Hydrocyanic Acid 20/a-D	67 33 221	20 to 200 ppm	2.5 to 25 ppm	360
Hydrogen Sulfide 10/a-D	67 33 091	10 to 300 ppm	1.3 to 40 ppm	361
Nitrogen Dioxide 10/a-D	81 01 111	10 to 200 ppm	1.3 to 25 ppm	362
Perchloroethylene 200/a-D	81 01 401	200 to 1500 ppm	25 to 200 ppm	363
Sulfur Dioxide 5/a-D	81 01 091	5 to 150 ppm	0.7 to 19 ppm	364
Toluene 100/a-D	81 01 421	100 to 3000 ppm	13 to 380 ppm	365
Trichloroethylene 200/a-D	81 01 441	200 to 1000 ppm	25 to 125 ppm	366

4.5 Dräger-Sampling-Tubes and Systems

Dräger-Tube	Order Code	Page
Activated Charcoal Tubes Type B	67 33 011	368
Activated Charcoal Tubes Type G	67 28 831	369
Activated Charcoal Tubes Type NIOSH	67 28 631	370
Activated Charcoal Tubes Type B/G	81 01 821	371
Aldehyde-Sampling-Set	64 00 271	372
Sampling Tubes Amines	81 01 271	373
Isocyanate-Sampling-Set	64 00 131	374
Nitrous-Oxide Diffusion Sampler	81 01 472	375
Diffusion Sampler ORSA 5	67 28 891	376
Silica Gel Tubes Type BIA	67 33 021	377
Silica Gel Tubes Type G	67 28 851	378
Silica Gel Tubes Type NIOSH	67 28 811	379

4.6 Overview of Substances for Measurement with Dräger-Sampling-Tubes and Systems

Substance	ORSA	Activated Charcoal	Silica Gel	Amine	Other
Acetic Acid, Amyl Ester		X			
Acetic Acid, Butyl Ester	X	X			
Acetic Acid, Ethyl Ester	X	X			
Acetic Acid, sec-Hexyl Ester	X	X			
Acetic Acid, Methyl Ester	X	X			
Acetic Acid Propyl Ester	X	X			
Acetic Acid, Vinyl Ester	X	X			
Acetone	X	X			
Acetonitrile	X	X			
Acrolein					A4
Acrylic Acid, Ethyl Ester	X	X			
Acrylic Acid, Methyl Ester	X	X			
Acrylonitrile	X	X			
Allyl Alcohol		X			
Allyl Chloride	X	X			
Amine (aliphatic)				X	
Aminobutane (all isomers)				X	
Aminocyclohexane				X	
2-Aminoethanol				X	
2-Aminopropane				X	
Amyl Acetate	X	X			
iso-Amyl Alcohol	X	X			
Aniline			X		
Benzene	X	X			
Bromochlorotrifluoroethane	X	X			
2-Bromo-2-chloro-1,1,1-trifluoroethane	X	X			
Bromoethane	X	X			
Bromoform	X	X			
Bromomethane	X	X			
1,3-Butadiene	X	X			
Butanol (all isomers)	X	X			
2-Butanone	X	X			
1-Butoxy-2,3-epoxypropane		X			
2-Butoxyethanol	X	X			
Butyl Acetate (all isomers)	X	X			

Substance	ORSA	Activated Charcoal	Silica Gel	Amine	Other
n-Butyl Acrylate	X	X			
Butyl Alcohol	X	X			
Butylamine (all isomers)				X	
p-tert-Butyltoluene	X	X			
Camphor		X			
Carbon Bisulfide		X			
Carbon Disulfide	X	X			
Carbon Tetrachloride	X	X			
Chlorobenzene	X	X			
Chlorobromomethane	X	X			
2-Chloro-1,3-butadiene	X	X			
1-Chloro-2,3-epoxypropane	X	X			
Chloroethane	X	X			
2-Chloroethanol	X	X			
bis-(2-Chloroethyl) Ether	X	X			
Chloroform	X	X			
Chloromethane		X			
2-Chloroprene	X	X			
3-Chloropropene	X	X			
3-Chloro-1-propene	X	X			
2-Chlorotoluene	X	X			
2-Chloro-1,1,2-trifluoroethyl (difluoromethyl)-ether	X	X			
1-Chloro-2,2,2-trifluoroethyl (difluoromethyl)-ether	X	X			
Cresol (all isomers)			X		
Cumene	X	X			
Cyclohexane	X	X			
Cyclohexanol		X			
Cyclohexanone	X	X			
Cyclohexene	X	X			
Cyclohexylamine				X	
Diacetone Alcohol		X			
1,2-Diaminoethane				X	
1,2-Dibromomethane	X	X			

Substance	ORSA	Activated Charcoal	Silica Gel	Amine	Other
1,2-Dichlorobenzene	X	X			
1,4-Dichlorobenzene	X	X			
o-Dichlorobenzene	X	X			
p-Dichlorobenzene	X	X			
2,2-Dichlorodiethyl Ether	X	X			
Dichlorodifluoromethane	X	X			
1,1-Dichloroethane	X	X			
1,2-Dichloroethane	X	X			
1,1-Dichloroethylene	X	X			
1,2-Dichloroethylene	X	X			
Dichlorofluoromethane	X	X			
Dichloromethane	X	X			
1,1-Dichloro-1-nitroethane	X	X			
1,2-Dichloropropane	X	X			
1,2-Dichloro-1,1,2,2-tetrafluoroethane	X	X			
Diethylamine				X	
Diethyl Ether	X	X			
Diethyl Sulfate				X	
Difluorobromomethane	X	X			
Difluorodibromomethane	X	X			
Difluoromonochloromethane	X	X			
Diisobutyl Ketone	X	X			
Diisopropyl Ether	X	X			
Dimethylamine				X	
N,N-Dimethylaniline		X			
Dimethylbenzene	X	X			
1,3-Dimethylbutyl Acetate	X	X			
1,1-Dimethylethylamine				X	
N,N-Dimethylethylamine				X	
Dimethylformamide				X	
Dimethyl Sulfate				X	
1,4-Dioxane	X	X			
Diphenyl Ether (vapour)		X			
Diphenylmethane-4,4'-diisocyanate					11
4,4'-Diphenylmethane Diisocyanate					11

Substance	ORSA	Activated Charcoal	Silica Gel	Amine	Other
Enflurane	X	X			
Epichlorohydrin	X	X			
1,2-Epoxypropane		X			
1,2-Ethanediol	X	X			
Ethanol	X	X			
Ethanolamine				X	
Ether	X	X			
2-Ethoxyethanol	X	X			
2-Ethoxyethyl Acetate	X	X			
Ethyl Acetate	X	X			
Ethyl Acrylate	X	X			
Ethyl Alcohol	X	X			
Ethylamine				X	
Ethylbenzene	X	X			
Ethyl Bromide	X	X			
Ethyl Chloride	X	X			
Ethylene Chloride	X	X			
Ethylene Chlorohydrin	X	X			
Ethylenediamine				X	
Ethylene Dibromide	X	X			
Ethylene Dichloride	X	X			
Ethylene Glycol	X	X			
Ethylene Glycol Mono-butyl Ether	X	X			
butyl Ether Acetate	X	X			
ethyl Ether	X	X			
ethyl Ether Acetate	X	X			
methyl Ether	X	X			
methyl Ether Acetate	X	X			
Ethylene Oxide	X	X			
Ethyl Ether	X	X			
Ethyl Formate	X	X			
Ethyl Glycol Acetate	X	X			
Ethyl Methyl Ketone	X	X			
Fluorotrichloromethane		X			

Substance	ORSA	Activated Charcoal	Silica Gel	Amine	Other
Formaldehyde			X		A4
Formic Acid Ethyl Ester	X	X			
Gasoline	X	X			
Glutaraldehyde					A4
Halothane	X	X			
HDI					I1
Heptane (all isomers)	X	X			
Hexachloroethane	X	X			
1,6-Hexamethylene Diisocyanate					I1
Hexamethylene Diisocyanate					I1
Hexane	X	X			
2-Hexanone	X	X			
Hexone	X	X			
sec-Hexyl Acetate	X	X			
Hydrazine					H3
4-Hydroxy-4-methylpentanone-2		X			
Iodomethane		X			
Isoamyl Alcohol	X	X			
Isocyanate					I1
Isoflurane	X	X			
Isophorone		X			
Isopropenyl Benzene	X	X			
Isopropyl Acetate	X	X			
Isopropyl Alcohol	X	X			
Isopropylamine				X	
Isopropylbenzene	X	X			
Isopropyl Ether	X	X			
Laughing Gas					L2
MDI					I1
Mesityl Oxide	X	X			
Methanol			X		
2-Methoxyethanol	X	X			
2-Methoxyethyl Acetate	X	X			
Methyl Acetate	X	X			
Methyl Acrylate	X	X			

Substance	ORSA	Activated Charcoal	Silica Gel	Amine	Other
Methylamine				X	
Methylamyl Alcohol		X			
Methyl Alcohol			X		
Methyl Bromide	X	X			
Methyl Butyl Ketone	X	X			
Methyl Chloride		X			
Methyl Chloroform	X	X			
Methylcyclohexane	X	X			
Methylcyclohexanol		X			
Methylene Chloride	X	X			
4,4'-Methylenediphenyl Diisocyanate					I1
Methyl Ethyl Ketone	X	X			
Methyl Glycol Acetate	X	X			
Methyl Iodide		X			
Methylisobutyl Carbinol		X			
Methyl Isobutyl Ketone	X	X			
Methyl Methacrylate	X	X			
4-Methyl-2-pentanol		X			
4-Methyl-2-pentanone	X	X			
2-Methyl-2-penten-4-one	X	X			
4-Methyl-3-penten-2-one	X	X			
2-Methyl-2-propanol	X	X			
Methyl Propyl Ketone	X	X			
N-Methyl-2-pyrrolidone (vapour)				X	
alpha-Methylstyrene	X	X			
Methyl Styrene	X	X			
Monochlorodifluoromethane		X			
Naphthalene		X			
Nitrobenzene			X		
Nitropropane			X		
2-Nitropropane			X		
Nitrotoluene			X		
Nitrous Oxide					L2
Octane	X	X			
Pentane (all isomers)	X	X			

Substance	ORSA	Activated Charcoal	Silica Gel	Amine	Other
2-Pentanone	X	X			
Pentyl Acetate		X			
Perchloroethane	X	X			
Perchloroethylene	X	X			
Phenol			X		
Phenylethylene	X	X			
Propanol (all isomers)	X	X			
2-Propenal					A4
2-Propen-1-ol		X			
Propyl Acetate (all isomers)	X	X			
Propyl Alcohol (all isomers)	X	X			
Propylene Dichloride	X	X			
1,2-Propylene Oxide	X	X			
n-Propyl Nitrate		X			
Pyridine	X	X			
R-11		X			
R-12		X			
R-21		X			
R-112	X	X			
R-113	X	X			
R-114	X	X			
Styrene	X	X			
TDI					I1
1,1,1,2-Tetrachloro-2,2-difluoroethane	X	X			
1,1,2,2-Tetrachloro-1,2-difluoroethane	X	X			
1,1,2,2-Tetrachloroethane	X	X			
Tetrachloroethylene	X	X			
Tetrachloromethane	X	X			
Tetrahydrofuran	X	X			
Toluene	X	X			
Toluene Diisocyanate					I1
Toluene-2,4-diisocyanate					I1
Toluene-2,6-diisocyanate					I1
1,1,1-Trichloroethane	X	X			
1,1,2-Trichloroethane	X	X			

Substance	ORSA	Activated Charcoal	Silica Gel	Amine	Other
Trichloroethylene	X	X			
Trichlorofluoromethane	X	X			
Trichloromethane	X	X			
1,2,3-Trichloropropane	X	X			
1,1,2-Trichloro-1,2,2-trifluoroethane	X	X			
Triethylamine				X	
Trifluorobromomethane	X	X			
Trimethylbenzene	X	X			
3,5,5-Trimethyl-2-cyclohexen-1-one	X	X			
Turpentine		X			
Vinyl Acetate	X	X			
Vinylbenzene	X	X			
Vinyl Chloride		X			
Vinylidene Chloride	X	X			
n-Vinyl-2-pyrrolidone				X	
Vinyltoluene	X	X			
Xylene (all isomers)	X	X			

4.7 Dräger-Chips

Chip	Measuring Range	Order Code	Page
Acetic Acid	2 - 50 ppm	64 06 330	387
Acetone	40 - 600 ppm	64 06 470	387
Ammonia	0.2 - 5 ppm	64 06 550	388
Ammonia	2 - 50 ppm	64 06 130	388
Ammonia	10 - 150 ppm	64 06 020	389
Ammonia	100 - 2000 ppm	64 06 570	389
Benzene	50 - 2500 ppb	64 06 600	390
Benzene	0.2 - 10 ppm	64 06 030	390
Benzene	0.5 - 10 ppm	64 06 160	391
Benzene	10 - 250 ppm	64 06 280	391
Butadiene	1 - 25 ppm	64 06 460	392
Carbon Dioxide	200 - 3000 ppm	64 06 190	392
Carbon Dioxide	1000 - 25000 ppm	64 06 070	393
Carbon Dioxide	1 - 20 Vol.-%	64 06 210	393
Carbon Monoxide	5 - 150 ppm	64 06 080	394
Chlorine	0.2 - 10 ppm	64 06 010	394
Ethanol	100 - 2500 ppm	64 06 370	395
Ethylene Oxide	0.4 - 5 ppm	64 06 580	395
Formaldehyde	0.2 - 5 ppm	64 06 540	396
Hydrochloric Acid	1 - 25 ppm	64 06 090	396
Hydrochloric Acid	20 - 500 ppm	64 06 140	397
Hydrocyanic Acid	2 - 50 ppm	64 06 100	397
Hydronen Peroxide	0.2 - 2 ppm	64 06 440	398
Hydrogen Sulfide	0.2 - 5 ppm	64 06 520	398
Hydrogen Sulfide	2 - 50 ppm	64 06 050	399
Hydrogen Sulfide	20 - 500 ppm	64 06 150	399
Hydrogen Sulfide	100 - 2500 ppm	64 06 220	400
Mercaptan	0.25 - 6 ppm	64 06 360	400
Methanol	20 - 500 ppm	64 06 380	401
Methylene Chloride	10 - 200 ppm	64 06 510	401
MTBE	10 - 200 ppm	64 06 530	402
Nitrogen Dioxide	0.5 - 25 ppm	64 06 120	402
Nitrous Fumes	0.5 - 15 ppm	64 06 060	403
Nitrous Fumes	10 - 200 ppm	64 06 240	403
Oxygen	1 - 30 Vol.-%	64 06 490	404

Chip	Measuring Range	Order Code	Page
Ozone	25 - 1000 ppb	64 06 430	404
Perchloroethylene	5 - 150 ppm	64 06 040	405
Petroleum Hydrocarbons	20 - 500 ppm	64 06 200	405
Petroleum Hydrocarbons	100 - 3000 ppm	64 06 270	406
Phosgene	0.05 - 2 ppm	64 06 340	406
Phosphine	0.1 - 2.5 ppm	64 06 400	407
Phosphine	1 - 25 ppm	64 06 410	407
Phosphine	20 - 500 ppm	64 06 420	408
Phosphine	200 - 5000 ppm	64 06 500	408
Propane	100 - 2000 ppm	64 06 310	409
i-Propanol	40 - 1000 ppm	64 06 390	409
Styrene	2 - 40 ppm	64 06 560	410
Sulfur Dioxide	0.4 - 10 ppm	64 06 110	410
Sulfur Dioxide	5 - 150 ppm	64 06 180	411
Toluene	10 - 300 ppm	64 06 250	411
Trichlorethylene	5 - 100 ppm	64 06 320	412
Vinyl Chloride	0.3 - 10 ppm	64 06 170	412
Vinyl Chloride	10 - 250 ppm	64 06 230	413
Water Vapor	0.4 - 10 mg/L	64 06 450	413
o-Xylene	10 - 300 ppm	64 06 260	414
Training Chip	Simulation	64 06 290	415

5. Data and Tables

5.1 Dräger-Tube Measurement System

5.1.1 Explanation to the Data about Dräger-Tubes

Dräger-Tube

The name, type designation and part number of the Dräger-Tube are given. The name of the tube indicates the particular contaminant that the tube has been calibrated to measure. The type designation consists of numbers and of a letter. As a general rule, the number indicates the lower end of the measuring range (in ppm, mg/m³, mg/L or Vol.-%). The letter following the number designates some change to the tube, typically the result of some improvement by further development (e. g. the Dräger-Tube Acetone 100/b). To characterise the Dräger-Diffusion-Tubes with direct indicationg, the letter "D" is added (e. g. the Dräger-Diffusion-Tube Ammonia 20/a-D).

Standard Measuring Range

The standard measuring range is calibrated at 20 °C and 1013 hPa (i. e. 1013 mbar). Accordingly, the number of pump strokes for the short-term tubes and the sampling time intervals for the diffusion tubes must be observed.

The instruction sheet packaged with each box of Dräger-Tubes should be consulted for all pertinent details. Furthermore, the measuring range for the Dräger-Tubes for short-term measurement is valid only when the Dräger-Tubes are used in conjunction with a Dräger-Tube pump.

Number of Strokes (n)

The number of pump strokes listed for a given short-term Dräger-Tube reflects the calibrated sample volume necessary for a given measuring range, using the Dräger-Tube pump.

For the Dräger-Tubes with a printed scale (i. e. scaled tubes), only the number of strokes which relate directly to the numerical values of the scale are given. For color intensity tubes (i. e. color match tubes), the highest and lowest number of strokes necessary to obtain a certain discoloration (i. e. determine the concentration) are indicated.

Time for Measurement

The average time for the completion of one measurement, related to the standard measuring range is given in seconds or minutes.

Standard Deviation

The standard deviation is a measure of the incidental deviations of the indicated values from their mean value. The standard deviation, which is actually a coefficient of variation (i.e. relative standard deviation), is given as a percentage and relates to the mean value. According to the first confidence interval 1σ , as it applies to Dräger-Tubes, 68.3 % of all measured values are within this standard deviation range.

For example:

Mean value	500 ppm
Standard Deviation	50 ppm

$$\text{Relative standard deviation} = \frac{50 \cdot 100}{500} = 10 \%$$

Color Change

The color of the indicating layer in the unused Dräger-Tube and the expected color change of the indicating layer in the presence of the particular contaminant is given (e. g. white → brownish green) as well as with a colored photo.

Attention:

Differences in the color of the printed photo and the real tube are possible due to variations of the printing process!

Ambient Operating Conditions

The measuring range of a Dräger-Tube is influenced by the ambient temperature and humidity. The recommended temperature range is given in degree centigrade and the absolute humidity limits are given in mg H₂O/L. Dräger-Tubes are calibrated at an atmospheric pressure of 1013 hPa (i. e. 1013 mbar). To correct for the influence of pressure, the value read from the tube scale must be multiplied by the following correction factor:

$$\text{Correction Factor} = \frac{1013 \text{ hPa}}{\text{actual atmospheric pressure in hPa}}$$

Reaction Principle

The reaction principle lists the basic reactants and the products of the reaction.

Cross Sensitivity

Dräger-Tubes are calibrated for a specific contaminant, but under other than ideal conditions, other interfering contaminants may also be present. Other contaminants that influence the indication are described as being cross sensitive.

The information given under the Cross Sensitivity section indicates which contaminants can influence the indication and which contaminants would not influence the indication. However, this information does not address all possibilities. The influence of other contaminants should be reviewed with the Dräger technical services department.

Extension of the Measuring Range

If the standard measuring range of a Dräger-Tube can be expanded by taking more or fewer pump strokes, the information, including pump strokes, correction factors, etc. will be given. If there is no information given, please contact the Dräger technical services group.

Additional Information

Supplementary points that must be considered when conducting a Dräger-Tube measurement are given here.

5.1.2 Data about Dräger-Tubes for Short-Term Measurements

Acetaldehyde 100/a

Order No. 67 26 665

Application Range

Standard Measuring Range:	100 to 1,000 ppm
Number of Strokes n:	20
Time for Measurement:	approx. 5 min
Standard Deviation:	± 15 to 20 %
Color Change:	orange → brownish-green

Ambient Operating Conditions

Temperature:	0 to 40 °C
Absolute Humidity:	3 to 15 mg H ₂ O / L

Reaction Principle

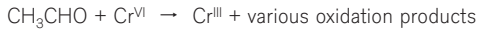

Cross Sensitivity

The tube does not differentiate between different aldehydes. Ethers, ketones, esters, aromatics and petroleum hydrocarbons are indicated, but with different sensitivities.



Acetic Acid 5/a

Order No. 67 22 101

A

Application Range

Standard Measuring Range:	5 to 80 ppm
Number of Strokes n:	3
Time for Measurement:	approx. 30 s
Standard Deviation:	± 10 to 15 %
Color Change:	blue violet → yellow

Ambient Operating Conditions

Temperature:	10 to 40 °C
Absolute Humidity:	< 30 mg H ₂ O / L

Reaction Principle

$\text{CH}_3\text{COOH} + \text{pH Indicator} \rightarrow \text{yellow reaction product}$

Cross Sensitivity

It is impossible to measure acetic acid in the presence of other acids.

Organic acids are indicated by the same color change, but with different sensitivities.

Mineral acids (e.g. hydrochloric acid) are indicated by red discolorations and different sensitivities.

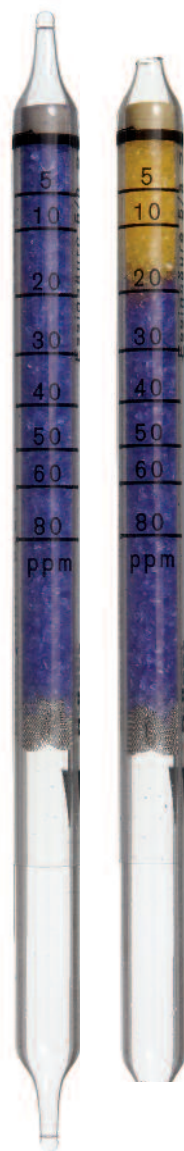

D-13595-2010

Acetone 40/a

Order No. 81 03 381

Application Range

Standard Measuring Range:	40 to 800 ppm
Number of Strokes n:	1
Time for Measurement:	approx. 1 min
Standard Deviation:	± 15 to 20 %
Color Change:	pale yellow → yellow

Ambient Operating Conditions

Temperature:	5 to 40 °C
Absolute Humidity:	5 to 40 mg H ₂ O / L

Reaction Principle

Acetone + 2,4-Dinitrophenylhydrazine → yellow hydrazone

Cross Sensitivity

Other ketones are indicated but with different sensitivities. Aldehydes are indicated. 500 ppm ethylacetate does not affect the indication. Ammonia causes the indicating layer to turn yellowish brown.



ST-569-2/008

Acetone 100/b

Order No. CH 22 901

A

Application Range

Standard Measuring Range:	100 to 12,000 ppm
Number of Strokes n:	10
Time for Measurement:	approx. 4 min
Standard Deviation:	± 15 to 20 %
Color Change:	pale yellow → yellow

Ambient Operating Conditions

Temperature:	0 to 40 °C
Absolute Humidity:	5 to 20 mg H ₂ O / L

Reaction Principle

Acetone + 2,4-Dinitrophenylhydrazine → yellow hydrazone

Cross Sensitivity

Other ketones are indicated but with different sensitivities. Aldehydes are indicated, but not esters. Ammonia causes the indicating layer to turn yellowish brown.



Acid Test

Order No. 81 01 121

Application Range

Standard Measuring Range:	Qualitative identification of acid gases.
Number of Strokes n:	1
Time for Measurement:	approx. 3 s
Standard Deviation:	± 30 %
Color Change:	blue violet → yellow or pink yellow

Ambient Operating Conditions

Temperature:	0 to 40 °C
Absolute Humidity:	3 to 15 mg H ₂ O / L

Reaction Principle

e. g. HCl + pH Indicator → pink yellow reaction product

Cross Sensitivity

This tube indicates various acid gases with differing sensitivities and colors ranging from yellow to pink. It is impossible to differentiate them.



ST-116-2001

Acrylonitrile 0.5/a

Order No. 67 28 591

A

Application Range

Standard Measuring Range:	1 to 20 ppm	/ 0.5 to 10 ppm
Number of Strokes n:	10	/ 20
Time for Measurement:	approx. 2 min	/ approx. 4 min
Standard Deviation:	± 15 to 20 %	
Color Change:	yellow → red	

Ambient Operating Conditions

Temperature:	0 to 40 °C
Absolute Humidity:	2 to 15 mg H ₂ O / L

Reaction Principle

- a) $\text{CH}_2=\text{CH-CN} + \text{Cr}^{\text{VI}} \rightarrow \text{HCN}$
 b₁) $\text{HCN} + \text{HgCl}_2 \rightarrow \text{HCl}$
 b₂) $\text{HCl} + \text{methyl red} \rightarrow \text{red reaction product}$

Cross Sensitivity

The indication is not affected by:

- 1,000 ppm acetone
- 20 ppm benzene
- 1,000 ppm ethyl acetate
- 1,000 ppm ethanol
- 10 ppm ethyl benzene
- 1,000 ppm hexane
- 100 ppm toluene

Styrene up to 50 ppm does not influence the indication. Butadiene reacts with the oxidation layer; in the presence of butadiene, the acrylonitrile indication will be too low (e.g. up to 50 % too low with 400 ppm butadiene).



Acrylonitrile 5/b

Order No. CH 26 901

Application Range

Standard Measuring Range:	5 to 30 ppm
Number of Strokes n:	3
Time for Measurement:	approx. 30 s
Standard Deviation:	± 15 to 20 %
Color Change:	yellow → red

Ambient Operating Conditions

Temperature:	0 to 40 °C
Absolute Humidity:	1 to 18 mg H ₂ O / L

Reaction Principle

- a) $\text{CH}_2=\text{CH}-\text{CN} + \text{Cr}^{\text{VI}} \rightarrow \text{HCN}$
 b₁) $\text{HCN} + \text{HgCl}_2 \rightarrow \text{HCl}$
 b₂) $\text{HCl} + \text{methyl red} \rightarrow \text{red reaction product}$

Cross Sensitivity

Styrene up to 50 ppm does not influence the indication. Butadiene reacts with the oxidation layer; in the presence of butadiene, the acrylonitrile indication will be too low (e.g. up to 50 % too low with 400 ppm butadiene).



Alcohol 25/a

Order No. 81 01 631

A

Application Range

Standard Measuring Range:	25 to 5,000 ppm Methanol
	50 to 4,000 ppm i-Propanol
(Methanol scale)	100 to 5,000 ppm n-Butanol
(Methanol scale)	25 to 2,000 ppm Ethanol
Number of Strokes n:	10
Time for Measurement:	approx. 5 min
Standard Deviation:	± 25 %
Color Change:	brown → brownish-black

Ambient Operating Conditions

Temperature:	15 to 30 °C
Absolute Humidity:	max. 15 mg H ₂ O / L

Reaction Principle

$\text{CH}_3\text{OH} + \text{Cr}^{\text{VI}} \rightarrow$ brownish-black reaction product

Cross Sensitivity

- 500 ppm n-octane result in an overall discoloration of the tube.
- 400 ppm ethylacetat = display of approx. 60 ppm methanol.
- 200 ppm tetrahydrofurane = display of approx. 900 ppm on i-propanol
- 1000 ppm acetone = display of approx. 200 ppm methanol.
- 400 ppm diethyl ether = display of approx. 1000 ppm methanol.

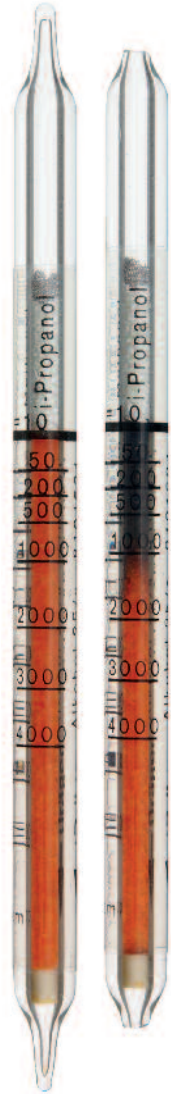

D-13322-2010

Alcohol 100/a

Order No. CH 29 701

Application Range

Standard Measuring Range:	100 to 3,000 ppm
Number of Strokes n:	10
Time for Measurement:	approx. 1.5 min.
Standard Deviation:	± 15 to 20 %
Color Change:	yellow → green

Ambient Operating Conditions

Temperature:	15 to 25 °C
Absolute Humidity:	< 20 mg H ₂ O / L

Reaction Principle

R-OH + Cr^{VI+} green reaction product

Cross Sensitivity

The tube does not differentiate between different alcohols. Higher molecular weight alcohols are indicated with a markedly reduced sensitivity. Aldehydes, ethers, ketones and esters are indicated, but with different sensitivity. Aromates, petroleum and halogenated hydrocarbons are not indicated.

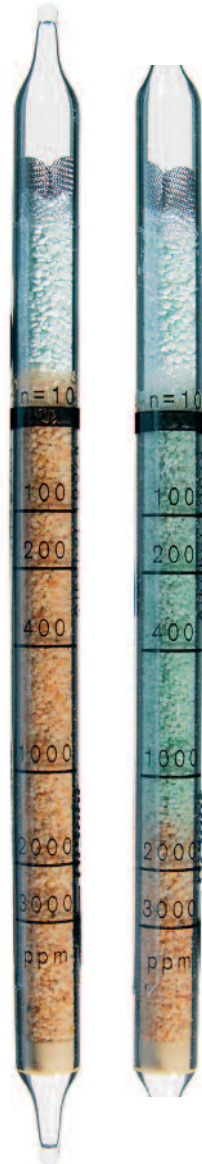

ST-5745-2004

Amine Test

Order No. 81 01 061

A

Application Range

Standard Measuring Range:	qualitative
Number of Strokes n:	1
Time for Measurement:	approx. 5 s
Standard Deviation:	± 30 %
Color Change:	yellow → blue

Ambient Operating Conditions

Temperature:	0 to 40 °C
Absolute Humidity:	3 to 15 mg H ₂ O / L

Reaction Principle

Amine + pH indicator → blue reaction product

Cross Sensitivity

The tube indicates unspecifically basic reacting gases with different sensitivities. It is impossible to differentiate between the basic reacting gases.

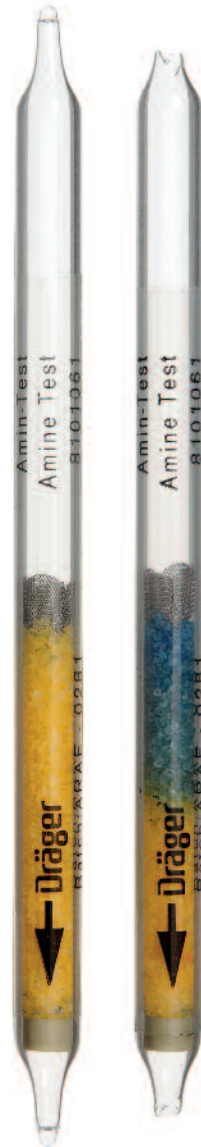

D-13318-2010

Ammonia 0.25/a

Order No. 81 01 711

Application Range

Standard Measuring Range:	0.25 to 3 ppm
Number of Strokes n:	10
Time for Measurement:	approx. 1 min
Standard Deviation:	± 10 to 15 %
Color Change:	yellow → blue

Ambient Operating Conditions

Temperature:	10 to 50 °C
Absolute Humidity:	< 20 mg H ₂ O / L

Reaction Principle

NH₃+ pH indicator → blue reaction product

Cross Sensitivity

Other basic substances such as e.g. organic amines are indicated as well, but with different sensitivity.

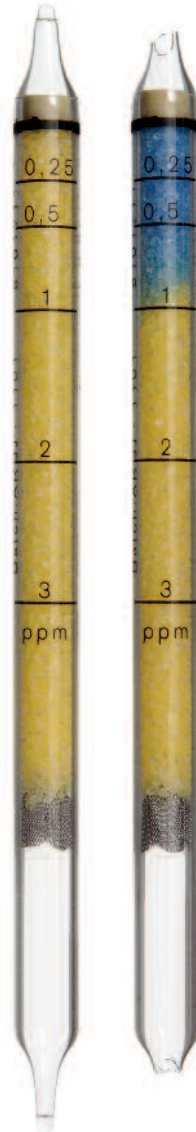

Ammonia 2/a

Order No. 67 33 231

A

Application Range

Standard Measuring Range:	2 to 30 ppm
Number of Strokes n:	5
Time for Measurement:	approx. 1 min
Standard Deviation:	± 10 to 15 %
Color Change:	yellow → blue

Ambient Operating Conditions

Temperature:	10 to 50 °C
Absolute Humidity:	< 20 mg H ₂ O / L

Reaction Principle

$\text{NH}_3 + \text{pH indicator} \rightarrow \text{blue reaction product}$

Cross Sensitivity

Other basic substances such as e.g. organic amines are indicated as well.

The indication is not affected by:

- 300 ppm nitrous fumes
- 2,000 ppm sulfur dioxide
- 2,000 ppm hydrogen sulfide



D-13816/2010

Ammonia 5/a

Order No. CH 20 501

Application Range

Standard Measuring Range:	5 to 70 ppm / 50 to 600 ppm
Number of Strokes n:	10 / 1
Time for Measurement:	approx. 60 sec./ 10 sec.
Standard Deviation:	± 10 to 15 %
Color Change:	yellow → blue

Ambient Operating Conditions

Temperature:	10 to 50 °C
Absolute Humidity:	< 20 mg H ₂ O / L

Reaction Principle

NH₃ + pH indicator → blue reaction product

Cross Sensitivity

Other basic substances such as e.g. organic amines are indicated as well.

The indication is not affected by:

- 300 ppm nitrous fumes
- 2,000 ppm sulfur dioxide
- 2,000 ppm hydrogen sulfide

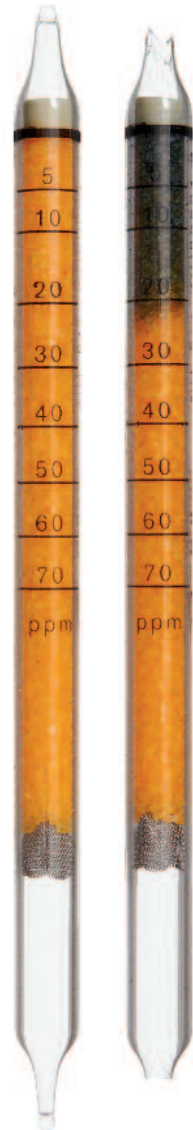

D-18344-2010

Ammonia 5/b

Order No. 81 01 941

A

Application Range

Standard Measuring Range:	5 to 100 ppm
Number of Strokes n:	1
Time for Measurement:	approx. 10 s
Standard Deviation:	± 10 to 15 %
Color Change:	yellow → blue

Ambient Operating Conditions

Temperature:	10 to 50 °C
Absolute Humidity:	< 20 mg H ₂ O / L

Reaction Principle

$\text{NH}_3 + \text{pH-indicator} \rightarrow \text{blue reaction product}$

Cross Sensitivity

Other basic substances such as e.g. organic amines are indicated as well.

The indication is not affected by:

- 300 ppm nitrous fumes
- 2,000 ppm sulfur dioxide
- 2,000 ppm hydrogen sulfide

Extension of the Measuring Range

Using $n = 2$ strokes, divide the reading by 2; the measuring range will be 2.5 to 50 ppm.



D-13329-2010

Ammonia 0.5%/a

Order No. CH 31 901

Application Range

Standard Measuring Range:	0.5 to 10 vol. %
Number of Strokes n:	1 + 1 desorption stroke in clean air
Time for Measurement:	20 s per stroke
Standard Deviation:	± 10 to 15 %
Color Change:	yellow → violet

Ambient Operating Conditions

Temperature:	10 to 30 °C
Absolute Humidity:	3 to 12 mg H ₂ O / L

Reaction Principle

NH₃ + pH indicator → purple reaction product

Cross Sensitivity

Other basic substances such as e.g. organic amines are indicated as well.

Extension of the Measuring Range

Using n = 10 + 1 desorptionstroke in clean air divide the reading by 10; the measuring range will be 0.05 to 1 % by vol.



Aniline 0.5/a

Order No. 67 33 171

A

Application Range

Standard Measuring Range:	0.5 to 10 ppm
Number of Strokes n:	20
Time for Measurement:	approx. 4 min
Standard Deviation:	± 15 to 20 %
Color Change:	pale yellow → pale green

Ambient Operating Conditions

Temperature:	15 to 30 °C
Absolute Humidity:	7 to 12 mg H ₂ O / L

Reaction Principle

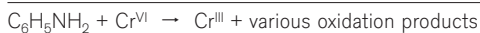

Cross Sensitivity

When methyl aniline and aniline are present at the same time, it is impossible to measure only the aniline concentration. Ethers, ketones, esters, aromatics and benzines are indicated as well but with different sensitivities.

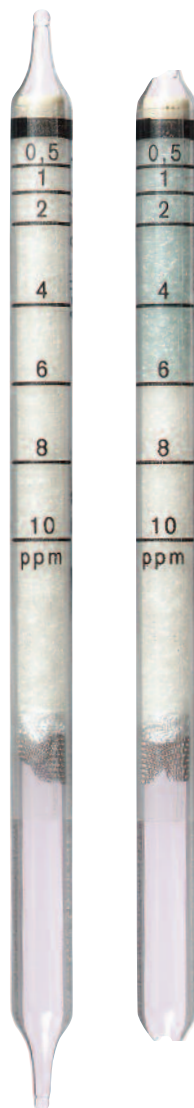

ST-14-2001

Aniline 5/a

Order No. CH 20 401

Application Range

Standard Measuring Range:	1 to 20 ppm
Number of Strokes n:	5 to 25
Time for Measurement:	max. 3 min
Standard Deviation:	± 30 %
Color Change:	white → red

Ambient Operating Conditions

Temperature:	15 to 40 °C
Absolute Humidity:	< 50 mg H ₂ O / L

Reaction Principle

Aniline + furfural → dianiline derivative of hydroxyglutacondialdehyde

Cross Sensitivity

N,N-Dimethylaniline is not indicated.

Ammonia concentrations up to 50 ppm do not affect the indication, higher ammonia concentrations will cause plus errors.



D-13349-2010

Arsine 0.05/a

Order No. CH 25 001

A

Application Range

Standard Measuring Range:	0.05 to 3 ppm
Number of Strokes n:	20
Time for Measurement:	approx. 6 min
Standard Deviation:	± 15 to 20 %
Color Change:	white → greyish-violett

Ambient Operating Conditions

Temperature:	0 to 40 °C
Absolute Humidity:	max. 40 mg H ₂ O / L

Reaction Principle

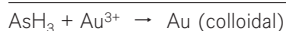

Cross Sensitivity

Phosphine and antimony hydride are indicated as well, but with different sensitivities. Hydrogen sulfide, mercaptans, ammonia and hydrogen chloride in the TLV range do not affect the indication. Carbon monoxide and sulfur dioxides in the TLV range also do not affect the indication.

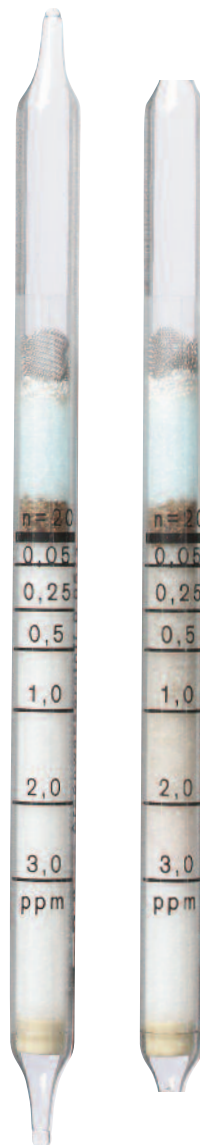

Benzene 0.25/a

Order No. 81 03 691

Application Range

Standard Measuring Range:	0.25 to 2 ppm / 2 to 10 ppm
Number of Strokes n:	5 / 1
Time for Measurement:	5 / 1
Standard Deviation:	± 15 %
Color Change:	light grey → dark grey to black

Ambient Operating Conditions

Temperature:	0 to 40 °C
Absolute Humidity:	< 40 mg H ₂ O / L

Reaction Principle

Benzene + Alu+ → dark grey to black reaction product

Cross Sensitivity

Up to a concentration of approx. 40 ppm (n=5) and 200 ppm (n=1), toluene, xylene and ethyl benzole are kept in the pre-layer where they cause a brown discolouration. 800 ppm n-Oktane (n=5) and 4000 ppm n-Octane (n=1) do not cause any discolouration in the indicating layer.



Benzene 1/a

Order No. 81 03 641

B

Application Range

Standard Measuring Range:	1 ppm
Number of Strokes n:	4
Time for Measurement:	approx. 3 min
Standard Deviation:	± 20 %
Color Change:	light grey → dark grey to black

Ambient Operating Conditions

Temperature:	0 to 40 °C
Absolute Humidity:	< 40 mg H ₂ O / L

Reaction Principle

Benzene + AlI_3 → dark grey to black reaction product

Cross Sensitivity

Alkanes are not indicated. Toluene, xylene, ethyl benzene, and other substituted aromatics up to a concentration of approx. brown discolouration (approx. 4 mm at 40 ppm). 200 ppm propene and 200 ppm 1-butene each to not cause any discolouration of the indicating layer.



D-5457-2004

Benzene 2/a

Order No. 81 01 231

Application Range

Standard Measuring Range:	2 to 60 ppm
Number of Strokes n:	20
Time for Measurement:	approx. 8 min
Standard Deviation:	± 10 to 15 %
Color Change:	white → brown grey

Ambient Operating Conditions

Temperature:	0 to 40 °C
Absolute Humidity:	1 to 15 mg H ₂ O / L

Reaction Principle

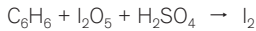

Cross Sensitivity

Alkyl benzenes such as toluene or xylene up to a concentration of 200 ppm do not affect the indication. It is impossible to measure benzene in the presence of petroleum hydrocarbons and carbon monoxide.



ST-198-4-2001

Benzene 5/a

Order No. 67 18 801

B

Application Range

Standard Measuring Range:	5 to 40 ppm
Number of Strokes n:	15 to 2
Time for Measurement:	max. 3 min
Standard Deviation:	± 30 %
Color Change:	white → red brown

Ambient Operating Conditions

Temperature:	0 to 40 °C
Absolute Humidity:	max. 50 mg H ₂ O / L

Reaction Principle

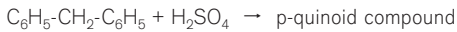

Cross Sensitivity

Other aromatics (toluene, xylene) are retained in the pre-layer causing a reddish brown discoloration. If the toluene or xylene concentrations are too high the entire pre-layer up to the indicating layer is discolored making a benzene measurement impossible. Petroleum hydrocarbons, alcohols and esters do not affect the indication.



SI-22-2001

Benzene 5/b

Order No. 67 28 071

Application Range

Standard Measuring Range:	5 to 50 ppm
Number of Strokes n:	20
Time for Measurement:	approx. 8 min
Standard Deviation:	± 10 to 15 %
Color Change:	white → brown green

Ambient Operating Conditions

Temperature:	0 to 40 °C
Absolute Humidity:	3 to 15 mg H ₂ O / L

Reaction Principle

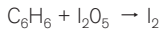

Cross Sensitivity

Many other petroleum hydrocarbons are indicated as well, but with different sensitivities. It is impossible to differentiate them. Other aromatics are indicated as well.

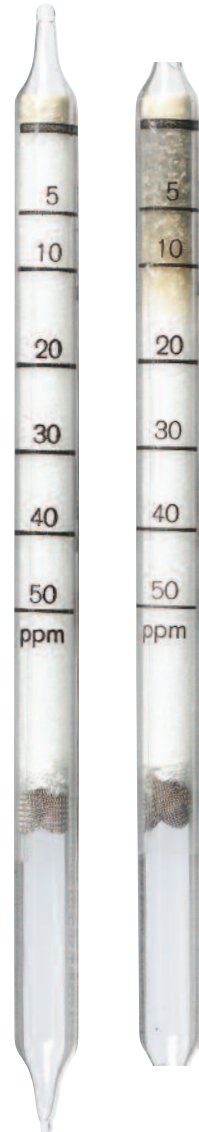

ST-28-2001

Application Range

Standard Measuring Range:	15 to 420 ppm
Number of Strokes n:	20 to 2
Time for Measurement:	max. 4 min
Standard Deviation:	± 30 %
Color Change:	white → red brown

Ambient Operating Conditions

Temperature:	0 to 30 °C
Absolute Humidity:	max. 30 mg H ₂ O / L

Reaction Principle

- a) $2 \text{C}_6\text{H}_6 + \text{HCHO} \rightarrow \text{C}_6\text{H}_5\text{-CH}_2\text{-C}_6\text{H}_5 + \text{H}_2\text{O}$
 b) $\text{C}_6\text{H}_5\text{-CH}_2\text{-C}_6\text{H}_5 + \text{H}_2\text{SO}_4 \rightarrow \text{p-quinoid compound}$

Cross Sensitivity

Other aromatics (toluene, xylene) are retained in the pre-layer causing a reddish brown discoloration. If the toluene or xylene concentrations are too high the entire pre-layer up to the indicating layer is discolored making a benzene measurement impossible. Petroleum hydrocarbons, alcohols and esters do not affect the indication.



Carbon Dioxide 100/a

Order No. 81 01 811

Application Range

Standard Measuring Range:	100 to 3,000 ppm
Number of Strokes n:	10
Time for Measurement:	approx. 4 min.
Standard Deviation:	± 10 to 15 %
Color Change:	white → pale violet/ blue violet

Ambient Operating Conditions

Temperature:	15 to 25 °C
Absolute Humidity:	max. 23 mg H ₂ O / L

Reaction Principle



Cross Sensitivity

No influence on the reading by 10 ppm hydrogen sulfide and 2 ppm sulfur dioxide.

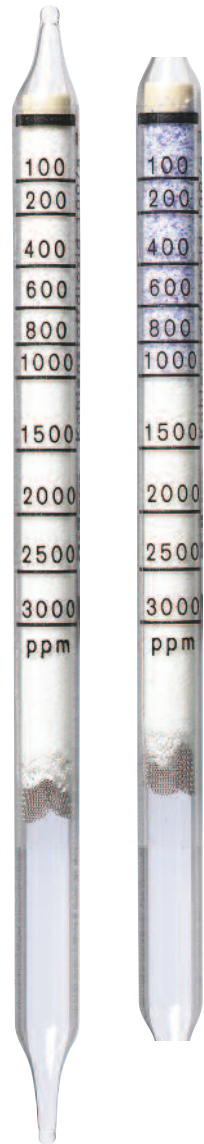

ST-51-2001

Carbon Dioxide 0.1%/a

Order No. CH 23 501

C

Application Range

Standard Measuring Range:	0.5 to 6 vol. % / 0.1 to 1.2 vol. %
Number of Strokes n:	1 / 5
Time for Measurement:	approx. 30 s / approx. 2.5 min
Standard Deviation:	± 5 to 10 %
Color Change:	white → violet

Ambient Operating Conditions

Temperature:	0 to 30 °C
Absolute Humidity:	max. 30 mg H ₂ O /L

Reaction Principle

CO₂ + Amine → violet reaction product

Cross Sensitivity

No influence on the reading by 10 ppm hydrogen sulfide and 2 ppm sulfur dioxide.



Carbon Dioxide 0.5%/a

Order No. CH 31 401

Application Range

Standard Measuring Range:	0.5 to 10 vol. %
Number of Strokes n:	1
Time for Measurement:	approx. 30 s
Standard Deviation:	± 5 to 10 %
Color Change:	white → violet

Ambient Operating Conditions

Temperature:	0 to 40 °C
Absolute Humidity:	max. 50 mg H ₂ O / L

Reaction Principle

CO₂ + amine → violet reaction product

Cross Sensitivity

Hydrogen sulfide in the TLV range does not interfere. In a range comparable to the calibrated range for carbon dioxide, sulfur dioxide is indicated. The sulfur dioxide sensitivity is approximately 1/3 (e.g. 3 vol. % sulfur dioxide gives an indication of 1 vol. %).

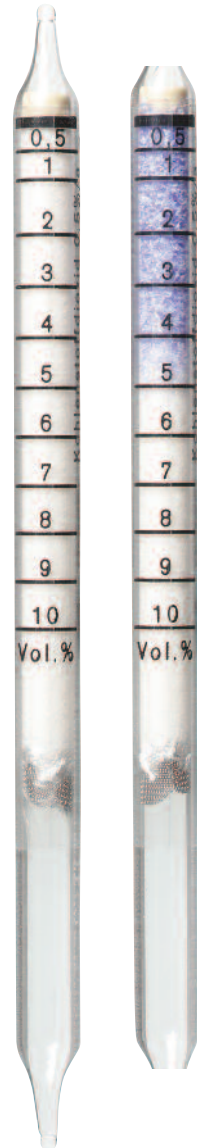

ST-54:2001

Carbon Dioxide 1%/a

Order No. CH 25 101

C

Application Range

Standard Measuring Range:	1 to 20 vol. %
Number of Strokes n:	1
Time for Measurement:	approx. 30 s
Standard Deviation:	± 5 to 10 %
Color Change:	white → violet

Ambient Operating Conditions

Temperature:	0 to 40 °C
Absolute Humidity:	max. 40 mg H ₂ O / L

Reaction Principle

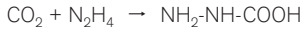

Cross Sensitivity

Hydrogen sulfide in the TLV range does not interfere. In a range comparable to the calibrated range for carbon dioxide, sulfur dioxide is indicated. The sulfur dioxide sensitivity is approximately $\frac{1}{3}$ (e.g. 6 vol. % sulfur dioxide gives an indication of 2 vol. %).

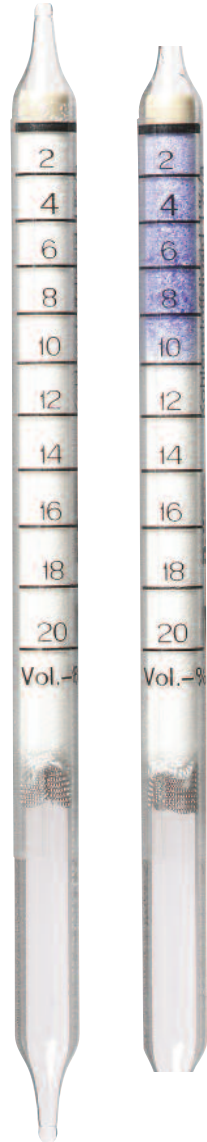

ST-55-2001

Carbon Dioxide 5%/A

Order No. CH 20 301

Application Range

Standard Measuring Range:	5 to 60 vol. %
Number of Strokes n:	1
Time for Measurement:	approx. 2 min
Standard Deviation:	± 10 to 15 %
Color Change:	white → violet

Ambient Operating Conditions

Temperature:	0 to 40 °C
Absolute Humidity:	max. 50 mg H ₂ O / L

Reaction Principle

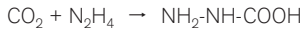

Cross Sensitivity

Hydrogen sulphide is not indicated near the limit value. Sulfur dioxide is indicated with comparable concentration range, however, with three times less the sensitivity.



D-13342-2010

Carbon Disulfide 3/a

Order No. 81 01 891

C

Application Range

Standard Measuring Range:	3 to 95 ppm
Number of Strokes n:	15 to 1
Time for Measurement:	max. 2 min
Standard Deviation:	± 30 %
Color Change:	pale blue → yellow green

Ambient Operating Conditions

Temperature:	0 to 40 °C
Absolute Humidity:	< 30 mg H ₂ O / L

Reaction Principle

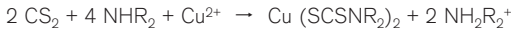

Cross Sensitivity

Hydrogen sulfide in the TLV range is retained in the pre-layer and does not interfere.



ST-5749-2004

Carbon Disulfide 5/a

Order No. 67 28 351

Application Range

Standard Measuring Range:	5 to 60 ppm
Number of Strokes n:	11
Time for Measurement:	approx. 3 min
Standard Deviation:	± 10 to 15 %
Color Change:	white → brown green

Ambient Operating Conditions

Temperature:	0 to 40 °C
Absolute Humidity:	3 to 15 mg H ₂ O / L

Reaction Principle

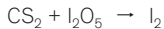

Cross Sensitivity

Aliphatic and aromatic hydrocarbons, carbon monoxide and hydrogen sulfide are indicated, but with different sensitivities. It is impossible to measure carbon disulfide in the presence of these substances.

Additional Information

These tubes become very warm during the measurement. Therefore this Dräger-Tube shall not be used in potentially combustible atmospheres. The lower explosion limit for carbon disulfide is 1 vol. %.

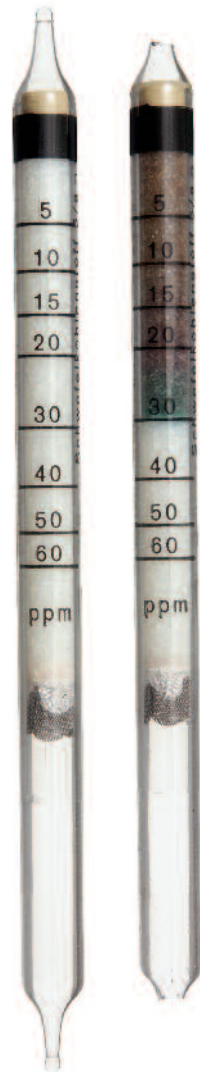

D-13309-2/010

Carbon Disulfide 30/a

Order No. CH 23 201

C

Application Range

Standard Measuring Range:	0.1 to 10 mg/L
Number of Strokes n:	6
Time for Measurement:	approx. 1 min
Standard Deviation:	± 15 to 20 %
Color Change:	pale blue → brown

Ambient Operating Conditions

Temperature:	0 to 40 °C
Absolute Humidity:	< 30 mg H ₂ O / L

Reaction Principle

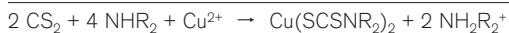

Cross Sensitivity

Hydrogen sulfide is indicated, producing a pale green discoloration. It is impossible to measure carbon disulfide in the presence of hydrogen sulfide.



D133462010

Carbon Monoxide 2/a

Order No. 67 33 051

Application Range

Standard Measuring Range:	2 to 60 ppm / 25 to 300 ppm
Number of Strokes n:	10 / 2
Time for Measurement:	approx. 4 min / 50 sec.
Standard Deviation:	± 10 to 15 %
Color Change:	white → brownish pink/green

Ambient Operating Conditions

Temperature:	0 to 50 °C
Absolute Humidity:	2 to 20 mg H ₂ O / L

Reaction Principle

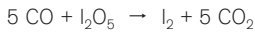

Cross Sensitivity

The following have no influence on the display of 10 ppm CO (respectively):

100 ppm hydrogen sulphide

50 ppm sulphur dioxide

15 ppm nitrogen dioxide

10 ppm CO + 200 ppm octane: display approx. 30 ppm

10 ppm CO + 40 ppm butadiene: display approx. 15 ppm

10 ppm CO + 30 (100) ppm benzene: display approx. 15 (20 - 30) ppm

10 ppm CO + 40 ppm chloroform: display approx. 60 ppm

10 (60) ppm acetylene: display approx. 5 (15) ppm

With the insertion of a carbon attachment tube (CH 24101),

10ppm CO can still be measured in the presence of 10000 ppm n-octane

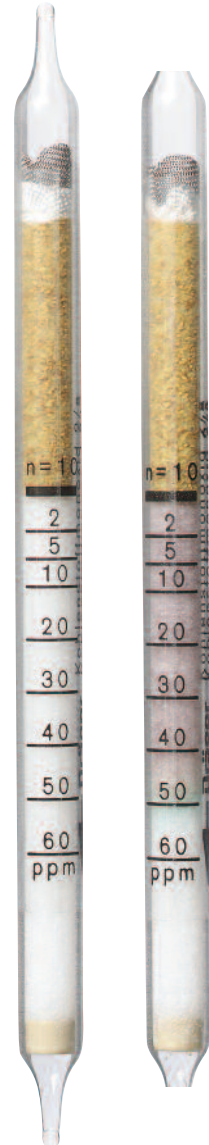

ST-64-2001

Carbon Monoxide 5/c

Order No. CH 25 601

C

Application Range

Standard Measuring Range:	100 to 700	/ 5 to 150 ppm
Number of Strokes n:	1	/ 5
Time for Measurement:	approx. 50 sec.	/ approx. 150 sec.
Standard Deviation:	± 10 to 15 %	
Color Change:	white → brownish-green	

Ambient Operating Conditions

Temperature:	0 to 50 °C
Absolute Humidity:	max. 50 mg H ₂ O / L

Reaction Principle

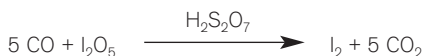

Cross Sensitivity

The following have no influence on the display of 10 ppm CO (respectively):

200ppm n-octane, with carbon attachment tube (CH 24101)

10000 ppm

30 ppm benzene

100 ppm hydrogen sulphide

50 ppm sulphur dioxide

15 ppm nitrogen dioxide

40 ppm butadiene

10 ppm CO + 100 ppm benzene: display approx. 20 ppm

10 ppm CO + 40 ppm chloroform: display approx. 60 ppm

10 (60) ppm acetylene: display 8 (20) ppm

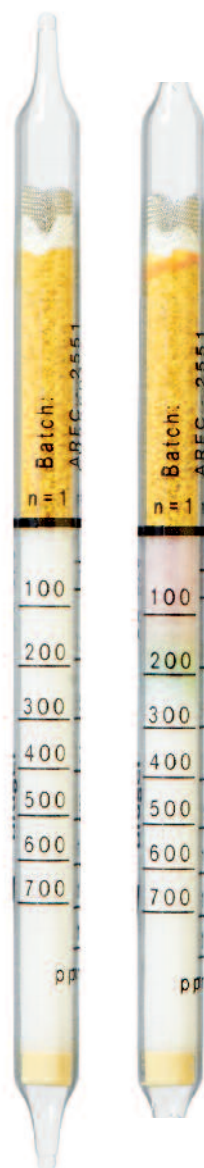

Carbon Monoxide 8/a

Order No. CH 19 701

Application Range

Standard Measuring Range:	8 to 150 ppm
Number of Strokes n:	10
Time for Measurement:	approx. 2 min
Standard Deviation:	± 10 to 15 %
Color Change:	white → pale brown

Ambient Operating Conditions

Temperature:	0 to 50 °C
Absolute Humidity:	< 50 mg H ₂ O / L

Reaction Principle

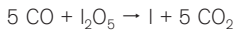

Cross Sensitivity

Acetylene is also indicated, however, with less sensitivity. Petroleum hydrocarbons, benzene, halogenated hydrocarbons and hydrogen sulfide are retained in the pre-layer. In the case of higher concentrations of interfering hydrocarbons, use should be made of a carbon pre-tube (CH 24 101). Higher concentrations of easily cleavable halogenated hydrocarbons (e.g. trichloroethylene), are liable to form chromyl chloride in the pre-layer which changes the indicating layer to a yellowish-brown. CO determination is impossible in the case of high olefin concentrations.

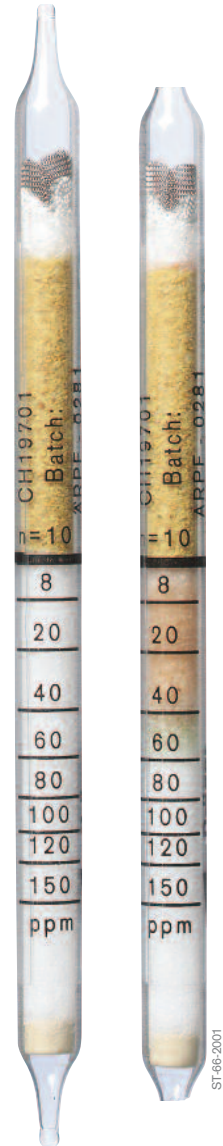

ST-66-2001

Carbon Monoxide 10/b

Order No. CH 20 601

C

Application Range

Standard Measuring Range:	100 to 3,000	/ 10 to 300 ppm
Number of Strokes n:	1	/ 10
Time for Measurement:	approx. 20 s	/ approx. 4 min
Standard Deviation:	± 10 to 15 %	
Color Change:	white → brown green	

Ambient Operating Conditions

Temperature:	0 to 50 °C
Absolute Humidity:	max. 50 mg H ₂ O / L

Reaction Principle

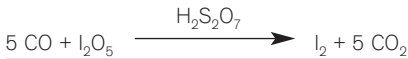

Cross Sensitivity

The following have no influence on the display of 10 ppm CO (respectively):

- 200ppm n-octane, with carbon attachment tube (CH 24101)
- 10000 ppm
- 30 ppm benzene
- 100 ppm hydrogen sulphide
- 50 ppm sulphur dioxide
- 15 ppm nitrogen dioxide
- 40 ppm butadiene
- 10 ppm CO + 100 ppm benzene: display approx. 30 ppm
- 10 ppm CO + 40 ppm chloroform: display approx. 35 ppm
- 10 (60) ppm acetylene: display 0 (70) ppm

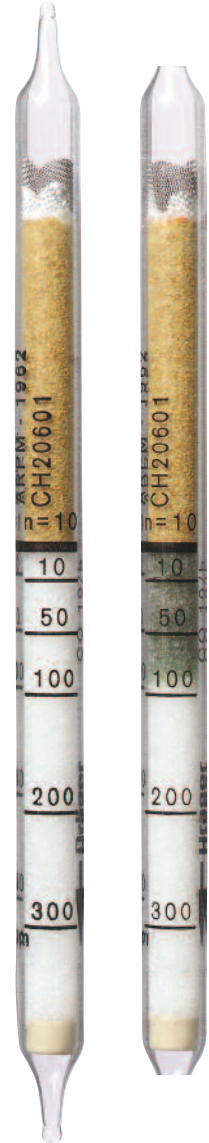

Carbon Monoxide 0.3%/b

Order No. CH 29 901

Application Range

Standard Measuring Range:	0.3 to 7 vol. % CO
Number of Strokes n:	1
Time for Measurement:	approx. 30 s
Standard Deviation:	± 10 to 15 %
Color Change:	white → brown green

Ambient Operating Conditions

Temperature:	0 to 50 °C
Absolute Humidity:	max. 50 mg H ₂ O / L

Reaction Principle

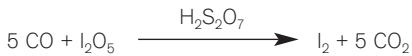

Cross Sensitivity

The following do not influence the display of 0.3 vol. % CO

- 10000 ppm n-octane
- 300 ppm benzene
- 500 ppm hydrogen sulphide
- 500 ppm sulphur dioxide
- 500 ppm nitrogen dioxide
- 300 ppm butadiene
- 250 ppm chloroform
- 3000 ppm acetylene result in a display of 0.3 vol. %



ST-70/2001

Carbon Tetrachloride 0.1/a

Order No. 81 03 501

C

Application Range

Standard Measuring Range:	0.1 to 5 ppm
Number of Strokes n:	5
Time for Measurement:	approx. 2.5 min
Standard Deviation:	± 20 to 15 %
Color Change:	yellow → blue-green

Ambient Operating Conditions

Temperature:	2 to 40 °C
Absolute Humidity:	1 to 40 mg / L

Reaction Principle

- a) $\text{CCl}_4 + \text{H}_2\text{S}_2\text{O}_7 \rightarrow \text{COCl}_2$
 b) $\text{COCl}_2 + \text{diethylaniline} + \text{dimethylaminobenzaldehyde} \rightarrow$
 blue-green reaction product

Cross Sensitivity

Phosgene is displayed with roughly the same sensitivity as carbon tetrachloride.

50 ppm Tetrachloroethylene will have a display of approx. 1 to 2 ppm,
 50 ppm trichloroethylene and 1.1 dichloroethylene will have a weak
 display of < 0.1 pmm.

No indication with:

- 10 ppm Vinyl Chloride
- 200 pmm 1,2-Dichloroethylene



ST-587-2008

Carbon Tetrachloride 1/a

Order No. 81 01 021

Application Range

Standard Measuring Range:	1 to 15 ppm	/ 10 to 50 ppm
Number of Strokes n:	10	/ 5
Time for Measurement:	approx. 6 min	/ 3 min
Standard Deviation:	± 15 to 20 %	
Color Change:	white → yellow	

Ambient Operating Conditions

Temperature:	15 to 30 °C
Absolute Humidity:	3 to 15 mg H ₂ O / L

Reaction Principle

- a) $\text{CCl}_4 + \text{H}_2\text{S}_2\text{O}_7 \rightarrow \text{COCl}_2$
 b) $\text{COCl}_2 + \text{Aromatic nitrogen compounds} \rightarrow \text{yellow reaction product}$

Cross Sensitivity

Chloropicrin and phosgene are indicated with the same sensitivity. It is impossible to measure carbon tetrachloride in the presence of chloropicrin and phosgene.

No interference from:

- 1 ppm chlorine
- 5 ppm hydrochloric acid
- 20 ppm methyl bromide
- 1,000 ppm acetone



D-13317-2010

Chlorine 0.2/a

Order No. CH 24 301

C

Application Range

Standard Measuring Range:	0.2 to 3 ppm	/ 3 to 30 ppm
Number of Strokes n:	10	/ 1
Time for Measurement:	approx. 3 min	/ 20 sec.
Standard Deviation:	± 10 to 15 %	
Color Change:	white → yellow orange	

Ambient Operating Conditions

Temperature:	0 to 40 °C
Absolute Humidity:	< 15 mg H ₂ O / L

Reaction Principle

$\text{Cl}_2 + o\text{-tolidine} \rightarrow \text{yellow orange reaction product}$

Cross Sensitivity

Bromine is indicated with the same sensitivity, but with a paler discoloration. Chlorine dioxide is indicated with different sensitivity.

Nitrogen dioxide is indicated as well, but with a paler discoloration and lower sensitivity.

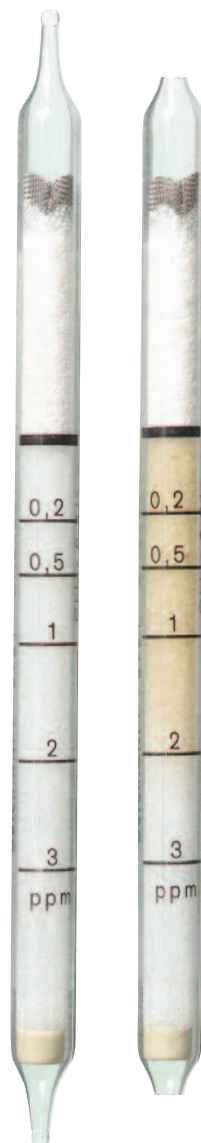

Chlorine 0.3/b

Order No. 67 28 411

Application Range

Standard Measuring Range:	0.3 to 5 ppm
Number of Strokes n:	20
Time for Measurement:	approx. 8 min.
Standard Deviation:	± 10 to 15 %
Color Change:	pale green-grey → brown

Ambient Operating Conditions

Temperature:	0 to 40 °C
Absolute Humidity:	< 15 mg H ₂ O / L

Reaction Principle

$\text{Cl}_2 + \text{o-tolidine} \rightarrow \text{brown reaction product}$

Cross Sensitivity

Bromine is indicated with the same sensitivity, but with a paler discoloration. Chlorine dioxide is indicated with different sensitivity. Nitrogen dioxide is indicated as well, but with a paler discoloration and lower sensitivity.

Extension of the Measuring Range

Using $n = 10$ strokes, multiply the reading by 2, the measuring range will be 0.6 to 10 ppm.

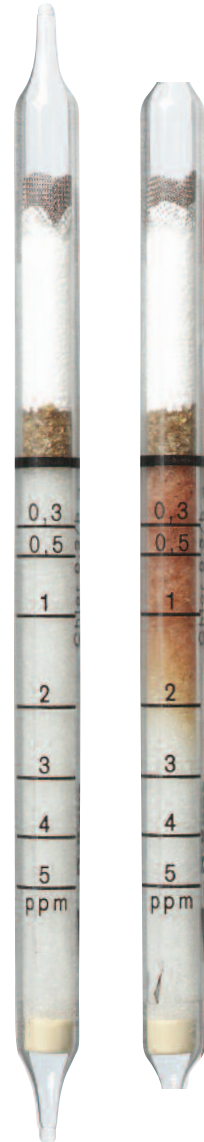

Chlorine 50/a

Order No. CH 20 701

C

Application Range

Standard Measuring Range:	50 to 500 ppm
Number of Strokes n:	1
Time for Measurement:	approx. 20 s
Standard Deviation:	± 10 to 15 %
Color Change:	grey green → orange brown

Ambient Operating Conditions

Temperature:	10 to 40 °C
Absolute Humidity:	< 40 mg H ₂ O / L

Reaction Principle

$\text{Cl}_2 + \text{o-tolidine} \rightarrow \text{orange brown reaction product}$

Cross Sensitivity

Bromine is indicated with the same sensitivity, but with a higher standard deviation ± 25 to 30 %. Chlorine dioxide and nitrogen dioxide are indicated as well, but with different sensitivities.



Chlorine Dioxide 0.025/a

Order No. 81 03 491

Application Range

Standard Measuring Range:	0.1 to 1 ppm	/ 0.025 to 0.1 ppm
Number of Strokes n:	10	/ 30
Time for Measurement:	approx. 2.5 min	/ approx. 7.5 min.
Standard Deviation:	± 10 to 15 %	
Color Change:	light grey → light green	

Ambient Operating Conditions

Temperature:	0 to 50 °C
Absolute Humidity:	≤ 50 mg / L

Reaction Principle

$\text{ClO}_2 + o\text{-Tolidine} \rightarrow \text{light green reaction product}$

Cross Sensitivity

The following values are not displayed:

1 ppm Cl_2 , 10 ppm H_2S , 1 ppm SO_2 ,

10 ppm methyl mercaptane.

1 ppm bromide is not displayed at a stroke count of $n = 10$,

at $n = 30$ there is a discoloration of approx. 10 mm.

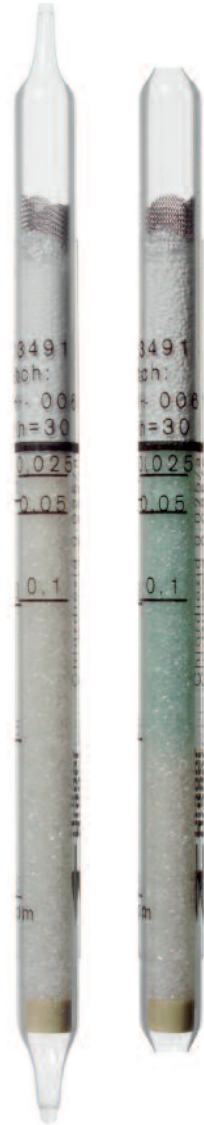

Chlorobenzene 5/a

Order No. 67 28 761



Application Range

Standard Measuring Range:	5 to 200 ppm
Number of Strokes n:	10
Time for Measurement:	approx. 3 min.
Standard Deviation:	± 10 to 15 %
Color Change:	blue → yellowish-grey

Ambient Operating Conditions

Temperature:	10 to 40 °C
Absolute Humidity:	3 to 15 mg H ₂ O / L

Reaction Principle

- $C_6H_5Cl + Cr^{VI} \rightarrow HCl$
- $HCl + \text{bromophenol blue} \rightarrow \text{yellow reaction product}$

Cross Sensitivity

Other chlorinated hydrocarbons are indicated as well, but with different sensitivities. Methylene chloride does not affect the indication. Chlorine and hydrogen chloride in the TLV range are absorbed in the pre-layer, but in such concentrations do not affect the indication.



D-13311-2010

Chloroform 2/a

Order No. 67 28 861

Application Range

Standard Measuring Range:	2 to 10 ppm
Number of Strokes n:	10
Time for Measurement:	approx. 9 min
Standard Deviation:	± 20 to 30 % at 20 °C and 9 mg H ₂ O / L
Color Change:	white → yellow

Ambient Operating Conditions

Temperature:	10 to 30 °C
Absolute Humidity:	9 mg H ₂ O / L

Reaction Principle

- $\text{CHCl}_3 + \text{Cr}^{\text{VI}} \rightarrow \text{Cl}_2$
- $\text{Cl}_2 + \text{o-tolidine} \rightarrow \text{yellow reaction product}$

Cross Sensitivity

Other chlorinated hydrocarbons are indicated, but with different sensitivities.



D-5442/2014

Chloroformate 0.2/b

Order No. 67 18 601

C

Application Range

Standard Measuring Range:	0.2 to 10 ppm
Number of Strokes n:	20
Time for Measurement:	approx. 3 min
Standard Deviation:	± 20 to 30 %
Color Change:	white → yellow

Ambient Operating Conditions

Temperature:	10 to 40 °C
Absolute Humidity:	5 to 15 mg H ₂ O / L

Reaction Principle

$\text{ClCOOR} + 4\text{-(4-nitrobenzyl)-pyridine} \rightarrow \text{yellow reaction product}$

Cross Sensitivity

Methyl, ethyl and isopropylchloroformate are indicated with approximately the same sensitivity. It is impossible to differentiate them. Petroleum hydrocarbons, aromatics, alcohols and ketones in the TLV range do not affect the indication. It is impossible to measure chloroformate in the presence of phosgene.

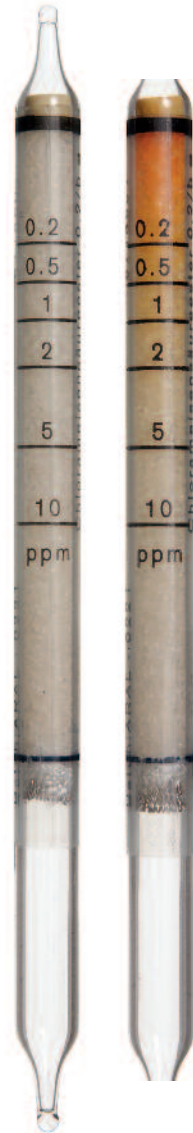

D:13304-2010

Chloropicrine 0.1/a

Order No. 81 03 421

Application Range

Standard Measuring Range:	0.1 to 2 ppm
Number of Strokes n:	15
Time for Measurement:	approx. 7.5 min
Standard Deviation:	± 20 to 30 %
Color Change:	yellow → blue green

Ambient Operating Conditions

Temperature:	0 to 40 °C
Absolute Humidity:	1 to 20 mg H ₂ O / L

Reaction Principle

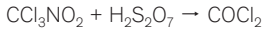

$\text{COCl}_2 + \text{diethylaniline} + \text{dimethylaminobenzaldehyde} \rightarrow$
bluish-green reaction product

Cross Sensitivity

The indication is not affected by:

- 50 ppm ammonia
- 10 ppm hydrocyanic acid
- 1 ppm ethylene oxide
- 1 ppm phosphine
- 5 ppm methyl bromide
- 15 ppm sulfuryl fluoride
- 10 ppm formaldehyde
- 10 ppm chloroform



Chloroprene 5/a

Order No. 67 18 901

C

Application Range

Standard Measuring Range:	5 to 60 ppm
Number of Strokes n:	3 + 3 desorption strokes in clean air.
Time for Measurement:	approx. 3 min
Standard Deviation:	± 10 to 15 %
Color Change:	violet → yellow brown

Ambient Operating Conditions

Temperature:	10 to 30 °C
Absolute Humidity:	3 to 15 mg H ₂ O / L

Reaction Principle



Cross Sensitivity

Many other organic compounds with C=C double bonds are indicated as well, but with different sensitivities. It is impossible to differentiate them. It is impossible to measure chloroprene in the presence of dialkyl sulfides.

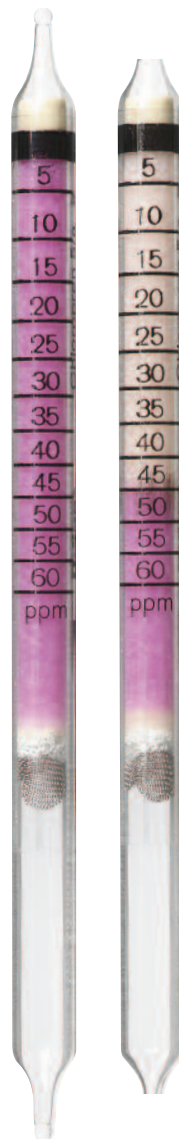

ST-36-2001

Chromic Acid 0.1/a

Order No. 67 28 681

Application Range

Standard Measuring Range:	0.1 to 0.5 mg/m ³ Discoloration compared to color standard.
Number of Strokes n:	40
Time for Measurement:	approx. 8 min
Standard Deviation:	± 50 %
Color Change:	white → violet

Ambient Operating Conditions

Temperature:	5 to 40 °C
Absolute Humidity:	< 20 mg H ₂ O / L

Reaction Principle

- $\text{CrO}_3 + \text{H}_2\text{SO}_4 \rightarrow \text{Cr}^{\text{VI}}$
- $\text{Cr}^{\text{VI}} + \text{diphenylcarbazide} \rightarrow \text{Cr}^{\text{III}} + \text{diphenylcarbazone}$

Cross Sensitivity

Metal chromates such as zinc or strontium chromate are indicated with about half the sensitivity.

Cr^{III} compounds do not affect the indication.

Very high chromate concentrations lead to a rapid bleaching of the indication. Measurements should be repeated with less strokes.

Additional Information

After carrying out the required 40 pump strokes the reagent ampoule must be broken, the liquid transferred onto the indicating layer and carefully drawn through it using the pump.



Cyanide 2/a

Order No. 67 28 791

C

Application Range

Standard Measuring Range:	2 to 15 mg/m ³
Number of Strokes n:	10 (+2)
Time for Measurement:	approx. 2.5 min
Standard Deviation:	± 20 to 30 %
Color Change:	yellow → red

Ambient Operating Conditions

Temperature:	0 to 30 °C
Absolute Humidity:	< 20 mg H ₂ O / L

Reaction Principle

- $2 \text{ KCN} + \text{H}_2\text{SO}_4 \rightarrow 2 \text{ HCN} + \text{K}_2\text{SO}_4$
- $2 \text{ HCN} + \text{HgCl}_2 \rightarrow 2 \text{ HCl} + \text{Hg}(\text{CN})_2$
- $\text{HCl} + \text{methyl red} \rightarrow \text{red reaction product}$

Cross Sensitivity

Free hydrogen cyanide is indicated already before breaking the ampoule.

Acid gases are indicated with different sensitivities.

A certain portion of the cyanide can have reacted with the CO₂ in the air through hydrolysis.

It is impossible to measure cyanide in the presence of phosphine.

Additional Information

After carrying out the 10 strokes the reagent ampoule must be broken, the liquid transferred onto the white separating layer and carefully drawn through with two strokes in cyanide free air using the pump. The indicating layer must not become moist.



Cyanogen Chloride 0.25/a

Order No. CH 19 801

Application Range

Standard Measuring Range:	0.25 to 5 ppm
Number of Strokes n:	20 to 1
Time for Measurement:	max. 5 min
Standard Deviation:	± 30 %
Color Change:	white → pink

Ambient Operating Conditions

Temperature:	5 to 40 °C
Absolute Humidity:	< 50 mg H ₂ O / L

Reaction Principle

- $\text{ClCN} + \text{pyridine} \rightarrow \text{glutaconaldehyde cyanamide}$
- Glutaconaldehyde + barbituric acid → pink reaction product

Cross Sensitivity

Cyanogen bromide is indicated as well, but with a different sensitivity. Calibration data is not available.

Additional Information

Before performing the measurement the reagent ampoule must be broken and the liquid transferred onto the indicating layer so that it is completely saturated.



Cyclohexane 100/a

Order No. 67 25 201

C

Application Range

Standard Measuring Range:	100 to 1,500 ppm
Number of Strokes n:	10
Time for Measurement:	approx. 5 min
Standard Deviation:	± 15 to 20 %
Color Change:	orange → green brown

Ambient Operating Conditions

Temperature:	15 to 40 °C
Absolute Humidity:	3 to 15 mg H ₂ O / L

Reaction Principle

$C_6H_{12} + Cr^{VI} \rightarrow Cr^{III} + \text{various oxidation products}$

Cross Sensitivity

Many petroleum hydrocarbons, alcohols, aromatics and esters are indicated as well, but with different sensitivities. It is not possible to differentiate between them.



ST-34-2001

Cyclohexylamine 2/a

Order No. 67 28 931

Application Range

Standard Measuring Range:	2 to 30 ppm
Number of Strokes n:	10
Time for Measurement:	approx. 4 min
Standard Deviation:	± 15 to 20 %
Color Change:	yellow → blue

Ambient Operating Conditions

Temperature:	15 to 35 °C
Absolute Humidity:	3 to 15 mg H ₂ O / L

Reaction Principle

$C_6H_{11}NH_2 + \text{pH-indicator} \rightarrow \text{blue reaction product}$

Cross Sensitivity

Other basic substances such as organic amines and ammonia are indicated as well.

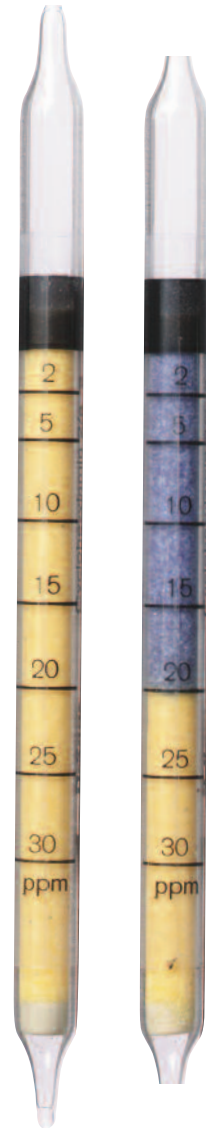

ST-35/2001

Diesel Fuel

Order No. 81 03 475

C

Application Range

Standard Measuring Range:	25 to 200 mg/m ³
Number of Strokes n:	5
Time for Measurement:	approx. 2.5 min.
Standard Deviation:	–
Color Change:	white → brown

Ambient Operating Conditions

Temperature:	0 to 40 °C
Absolute Humidity:	≤ 40 mg H ₂ O / L

Reaction Principle

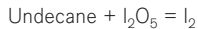

Cross Sensitivity

Various organic compounds with changing sensitivity are displayed.



ST-364-2008

Diethyl Ether 100/a

Order No. 67 30 501

Application Range

Standard Measuring Range:	100 to 4,000 ppm
Number of Strokes n:	10
Time for Measurement:	approx. 3 min
Standard Deviation:	± 15 to 20 %
Color Change:	orange → green brown

Ambient Operating Conditions

Temperature:	15 to 40 °C
Absolute Humidity:	3 to 15 mg H ₂ O / L

Reaction Principle



Cross Sensitivity

Many petroleum hydrocarbons, alcohols, aromatics and esters are indicated as well, but with different sensitivities. It is not possible to differentiate between them.

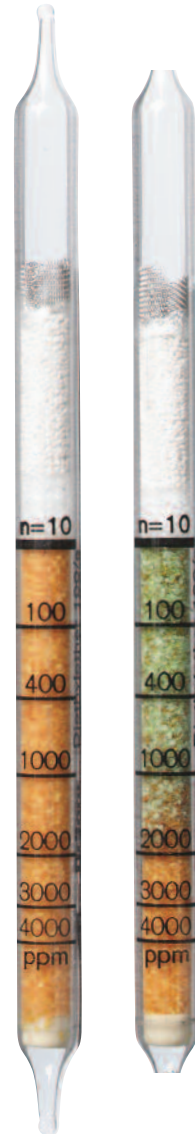

ST-36-2001

Dimethyl Formamide 10/b

Order No. 67 18 501

D

Application Range

Standard Measuring Range:	10 to 40 ppm
Number of Strokes n:	10
Time for Measurement:	approx. 3 min
Standard Deviation:	± 20 to 30 %
Color Change:	yellow → greyblue

Ambient Operating Conditions

Temperature:	15 to 35 °C
Absolute Humidity:	3 to 12 mg H ₂ O / L

Reaction Principle

- Dimethylformamide + NaOH → NH₃
- NH₃ + pH-indicator → greyblue reaction product

Cross Sensitivity

Other basic substances, e.g. ammonia, organicsamines and hydrazine are also indicate, however, with differing sensitivity.



ST-37-2001

Dimethyl Sulfate 0.005/c

Order No. 67 18 701

Application Range

Standard Measuring Range:	0.005 to 0.05 ppm
	Discoloration compared to color standard.
Number of Strokes n:	200
Time for Measurement:	approx. 50 min
Standard Deviation:	± 30 %
Color Change:	white → blue

Ambient Operating Conditions

Temperature:	15 to 30 °C
Absolute Humidity:	3 to 15 mg H ₂ O / L

Reaction Principle

Dimethyl sulphate + 4-(4-Nitrobenzyl)-pyridine → colorless alkylation product
 colorless alkylation product → blue reaction product

Cross Sensitivity

Phosgene and chloroformates cause a yellow discoloration of the indicating layer, and it is impossible to perform a dimethyl sulphate measurement. Alcohols, ketones, aromatics and petroleum hydrocarbons in the TLV range do not affect the indication.

Additional Information

After carrying out the required 200 pump strokes the reagent ampoule must be broken, the liquid transferred onto the indicating layer and carefully drawn through it using the pump. Wait five minutes before evaluating the indication. The tube must not be exposed to direct sunlight during the 5 minutes waiting period.

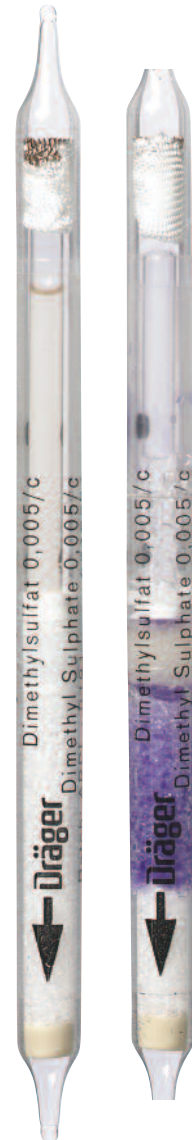

ST-39-2001

Dimethyl Sulfide 1/a

Order No. 67 28 451

D

Application Range

Standard Measuring Range:	1 to 15 ppm
Number of Strokes n:	20
Time for Measurement:	approx. 15 min
Standard Deviation:	± 15 to 30 %
Color Change:	violet → yellow brown

Ambient Operating Conditions

Temperature:	15 to 30 °C
Absolute Humidity:	< 20 mg H ₂ O / L

Reaction Principle

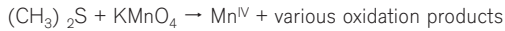

Cross Sensitivity

Many organic compounds with C=C double bonds are indicated as well, but with different sensitivities. It is impossible to differentiate between them. H₂S (hydrogen sulfide) is indicated with approximately twice the sensitivity. The tube H₂S 5/b can be used as a filtering tube. Then, with n = 20 pump strokes approx. 30 ppm H₂S is retained. Methyl mercaptan is indicated with approximately twice the sensitivity.



ST-186-2001

Epichlorhydrine 5/c

Order No. 67 28 111

Application Range

Standard Measuring Range:	5 to 80 ppm
Number of Strokes n:	20
Time for Measurement:	approx. 8 min
Standard Deviation:	± 15 to 20 %
Color Change:	pale gray → yellow orange

Ambient Operating Conditions

Temperature:	10 to 40 °C
Absolute Humidity:	5 to 15 mg H ₂ O / L

Reaction Principle



Cross Sensitivity

Other chlorinated hydrocarbons are indicated as well but with different sensitivities. It is not possible to measure epichlorohydrine in the presence of free halogens and hydrogen halides in the TLV range because they are indicated as well. Petroleum hydrocarbons cause low readings.

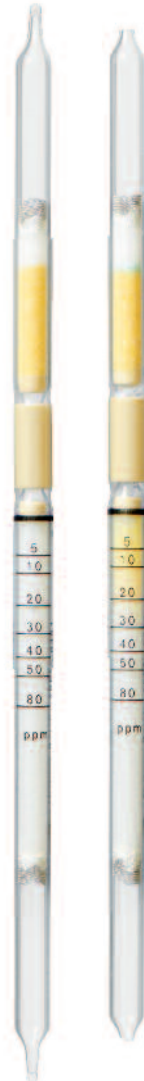

D-54402014

Ethyl Acetate 200/a

Order No. CH 20 201

D

Application Range

Standard Measuring Range:	200 to 3,000 ppm
Number of Strokes n:	20
Time for Measurement:	approx. 5 min
Standard Deviation:	± 15 to 20 %
Color Change:	orange → green brown

Ambient Operating Conditions

Temperature:	17 to 40 °C
Absolute Humidity:	3 to 15 mg H ₂ O / L

Reaction Principle

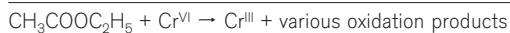

Cross Sensitivity

Many petroleum hydrocarbons, alcohols, aromatics and esters are indicated, but with different sensitivities. It is impossible to differentiate between them.



Ethyl Benzene 30/a

Order No. 67 28 381

Application Range

Standard Measuring Range:	30 to 400 ppm
Number of Strokes n:	6
Time for Measurement:	approx. 2 min
Standard Deviation:	± 10 to 15 %
Color Change:	white → brown

Ambient Operating Conditions

Temperature:	10 to 30 °C
Absolute Humidity:	5 to 12 mg H ₂ O / L

Reaction Principle

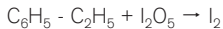

Cross Sensitivity

Many petroleum hydrocarbons and aromatics are indicated, but with different sensitivities. It is impossible to differentiate between them.

Extension of the Measuring Range

Using n = 4, multiply the reading by 1.5; the measuring range will be 45 to 600 ppm.



ST-41-2001

Ethyl Formate 20/a

Order No. 81 03 541

E

Application Range

Standard Measuring Range:	20 to 500 ppm
Number of Strokes n:	20
Time for Measurement:	approx. 5 min
Standard Deviation:	± 30 %
Color Change:	orange → greenbrown

Ambient Operating Conditions

Temperature:	15 to 40 °C
Absolute Humidity:	1 to 15 mg / L

Reaction Principle

$\text{HCOOC}_2\text{H}_5 + \text{Cr}^{6+} \rightarrow \text{Cr}^{3+} + \text{various oxidation products}$

Cross Sensitivity

At 100 ppm ethyl formate has no effect from: 500 ppm carbon dioxide (CO₂) and 10 ppm carbon monoxide (CO).

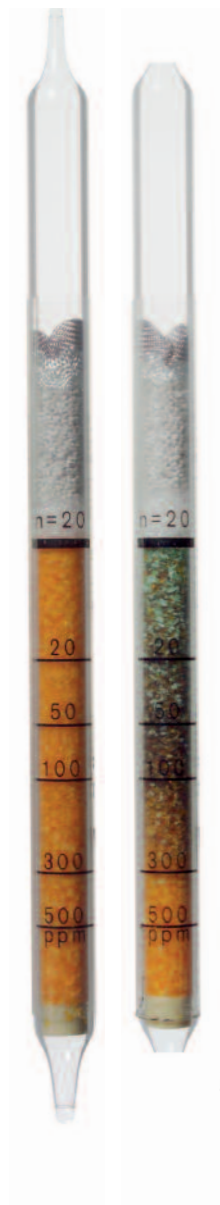

Ethyl Glycol Acetate 50/a

Order No. 67 26 801

Application Range

Standard Measuring Range:	50 to 700 ppm
Number of Strokes n:	10
Time for Measurement:	approx. 3 min
Standard Deviation:	± 20 to 30 %
Color Change:	yellow → turquoise green

Ambient Operating Conditions

Temperature:	10 to 35 °C
Absolute Humidity:	5 to 12 mg H ₂ O / L

Reaction Principle

Ethyl glycol acetate + Cr^{VI} → Cr^{III} + various oxidation products

Cross Sensitivity

Alcohols, esters, aromatics and ethers are also indicated, but with different sensitivities. It is impossible to differentiate between them.



D-13307-2010

Ethylene 0.1/a

Order No. 81 01 331

E

Application Range

Standard Measuring Range:	0.2 to 5 ppm
Number of Strokes n:	20
Time for Measurement:	approx. 30 min
Standard Deviation:	± 15 to 30 %
Color Change:	pale yellow → greyish blue

Ambient Operating Conditions

Temperature:	10 to 40 °C
Absolute Humidity:	5 to 20 mg H ₂ O / L

Reaction Principle

$\text{CH}_2=\text{CH}_2 + \text{Pd-Molybdate complex} \rightarrow \text{blue reaction product}$

Cross Sensitivity

Other similar compounds are indicated in addition to ethylene, e.g.:

- 100 ppm butadiene result in a reading of 1 ppm
- 50 ppm butylene result in a reading of 1 ppm
- 5 ppm propylene result in a reading of 1 ppm
- 20 ppm hydrogen sulfide result in a reading of 2 ppm
- 25 ppm CO change the indicating layer to a greyish blue.



ST-5789-2004

Ethylene 50/a

Order No. 67 28 051

Application Range

Standard Measuring Range:	50 to 2,500 ppm
Number of Strokes n:	3
Time for Measurement:	approx. 6 min
Standard Deviation:	± 20 to 30 %
Color Change:	yellow → blue

Ambient Operating Conditions

Temperature:	15 to 40 °C
Absolute Humidity:	< 30 mg H ₂ O / L

Reaction Principle

$\text{CH}_2=\text{CH}_2 + \text{Pd-Molybdate complex} \rightarrow \text{blue reaction product}$

Cross Sensitivity

Organic compounds with C=C double bonds are indicated, but with different sensitivities. It is impossible to differentiate between them. In the presence of CO, the indicating layer is colored blue depending upon the CO concentration and its exposure time. H₂S is indicated by a black color, but with considerably lower sensitivity.

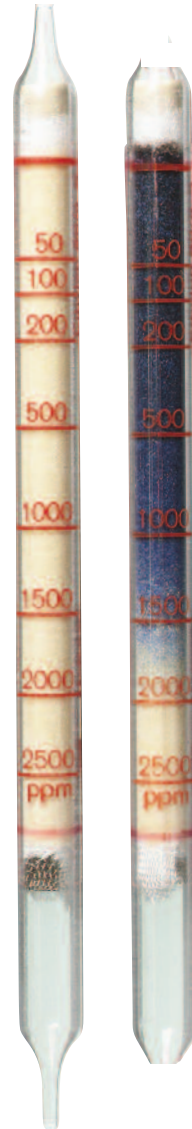

ST-49-2001

Ethylene Glycol 10

Order No. 81 01 351

E

Application Range

Standard Measuring Range:	10 to 180 mg/m ³ Corresponds to 4 to 70 ppm.
Number of Strokes n:	10
Time for Measurement:	approx. 7 min
Standard Deviation:	± 20 to 30 %
Color Change:	white → pink

Ambient Operating Conditions

Temperature:	10 to 35 °C
Absolute Humidity:	5 to 15 mg H ₂ O / L

Reaction Principle

- $\text{OH-C}_2\text{H}_4\text{-OH} \rightarrow \text{HCHO}$
- $\text{HCHO} + \text{C}_6\text{H}_4(\text{CH}_3)_2 + \text{H}_2\text{SO}_4 \rightarrow \text{quinoid reaction products}$

Cross Sensitivity

Styrene, vinyl acetate and acetaldehyde are indicated with a yellowish brown discoloration.

It is impossible to measure ethylene glycol in the presence of formaldehyde and ethylene oxide because they produce the same discoloration.

Additional Information

The reagent ampoule must be broken before carrying out the measurement.



ST-198/2001

Ethylene Oxide 1/a

Order No. 67 28 961

Application Range

Standard Measuring Range:	1 to 15 ppm
Number of Strokes n:	20
Time for Measurement:	approx. 8 min
Standard Deviation:	± 20 to 30 %
Color Change:	white → pink

Ambient Operating Conditions

Temperature:	10 to 30 °C
Absolute Humidity:	3 to 15 mg H ₂ O / L

Reaction Principle

- Ethylene Oxide → HCHO
- $\text{HCHO} + \text{C}_6\text{H}_4(\text{CH}_3)_2 + \text{H}_2\text{SO}_4 \rightarrow$ quinoid reaction products

Cross Sensitivity

Styrene, vinyl acetate and acetaldehyde are indicated with a yellowish brown discoloration.

It is impossible to measure ethylene oxide in the presence of ethylene glycol and formaldehyde because they produce the same discoloration.

Additional Information

The reagent ampoule must be broken before carrying out the measurement.



ST-2004-2001

Ethylene Oxide 25/a

Order No. 67 28 241

E

Application Range

Standard Measuring Range:	25 to 500 ppm
Number of Strokes n:	30
Time for Measurement:	approx. 6 min
Standard Deviation:	± 20 to 30 %
Color Change:	pale yellow → turquoise green

Ambient Operating Conditions

Temperature:	15 to 30 °C
Absolute Humidity:	3 to 15 mg H ₂ O / L

Reaction Principle

Ethylene oxide + Cr^{VI} → Cr^{III} + various oxidation products

Cross Sensitivity

Alcohols, esters and aldehydes are also indicated, but with different sensitivities. It is impossible to differentiate between them. Propylene oxide is also indicated, but with a different sensitivity. Ethylene, ketones and toluene in the TLV range do not interfere.



Fluorine 0.1/a

Order No. 81 01 491

Application Range

Standard Measuring Range:	0.1 to 2 ppm
Number of Strokes n:	20
Time for Measurement:	approx. 5 min
Standard Deviation:	± 15 to 20 %
Color Change:	white → yellow

Ambient Operating Conditions

Temperature:	10 to 40 °C
Absolute Humidity:	< 10 mg H ₂ O / L

Reaction Principle

- $F_2 + MgCl_2 \rightarrow Cl_2 + Mg F_2$
- $Cl_2 + o\text{-tolidine} \rightarrow \text{yellow reaction product}$

Cross Sensitivity

Nitrogen dioxide, chlorine and chlorine dioxide are indicated, but with different sensitivities.

Extension of the Measuring Range

Using n = 40, divide the reading by 2; the measuring range will be 0.05 to 1 ppm.

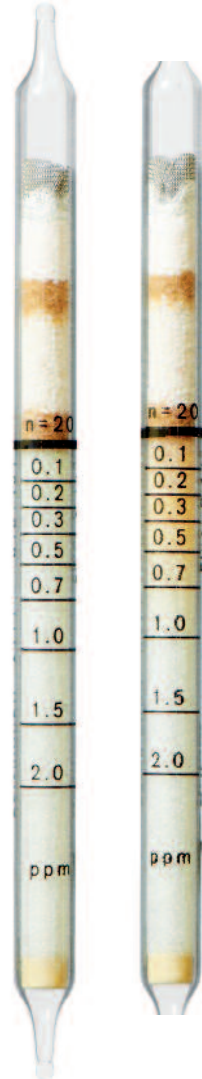

Formaldehyde 0.2/a

Order No. 67 33 081

E

Application Range

Standard Measuring Range:	0.5 to 5	/ 0.2 to 2.5 ppm
Number of Strokes n:	10	/ 20
Time for Measurement:	approx. 1.5 min	/ approx. 3 min
Standard Deviation:	± 20 to 30 %	
Color Change:	white → pink	

Ambient Operating Conditions

Temperature:	10 to 40 °C
Absolute Humidity:	3 to 15 mg/ L

Reaction Principle

$$\text{HCHO} + \text{C}_6\text{H}_4(\text{CH}_3)_2 + \text{H}_2\text{SO}_4 \rightarrow \text{quinoid reaction products}$$

Cross Sensitivity

Styrene, vinyl acetate, acetaldehyde, acrolein, diesel fuel and furfuryl alcohol are indicated with a yellowish brown discoloration. 500 ppm octane, 5 ppm nitric oxide and 5 ppm nitrogen dioxide have no effect.

Extension of the Measuring Range

The measuring range can be extended in conjunction with the activation tube (Order No. 81 01 141). The following information applies to the n = 20 stroke scale:

Pump Strokes	Scale divided by	Range
40	2	0.1 to 1.25 ppm
80	4	0.05 to 0.63 ppm
100	5	0.04 to 0.5 ppm



Formaldehyde 2/a

Order No. 81 01 751

Application Range

Standard Measuring Range:	2 to 40 ppm
Number of Strokes n:	5
Time for Measurement:	approx. 30 s
Standard Deviation:	± 20 to 30 %
Color Change:	white → pink

Ambient Operating Conditions

Temperature:	0 to 40 °C
Absolute Humidity:	3 to 15 mg H ₂ O / L

Reaction Principle

$$\text{HCHO} + \text{C}_6\text{H}_4(\text{CH}_3)_2 + \text{H}_2\text{SO}_4 \rightarrow \text{quinoid reaction products}$$

Cross Sensitivity

Styrene, vinyl acetate, acetaldehyde, acrolein, diesel fuel and furfuryl alcohol are indicated with a yellowish brown discoloration. 500 ppm Octane, 5 ppm nitric oxide and 5 ppm nitrogen dioxide have no effect.

Additional Information

The reagent ampoule must be broken before carrying out the measurement.



Formic Acid 1/a

Order No. 67 22 701

F

Application Range

Standard Measuring Range:	1 to 15 ppm
Number of Strokes n:	20
Time for Measurement:	approx. 3 min
Standard Deviation:	± 10 to 15 %
Color Change:	blue violet → yellow

Ambient Operating Conditions

Temperature:	10 to 50 °C
Absolute Humidity:	< 30 mg H ₂ O / L

Reaction Principle

HCOOH + pH indicator → yellow reaction product

Cross Sensitivity

It is impossible to measure formic acid in the presence of other acids. Organic acids are indicated by the same color change, but partly with different sensitivity. Mineral acids, e.g. hydrochloric acid are indicated with different sensitivity and by red color.

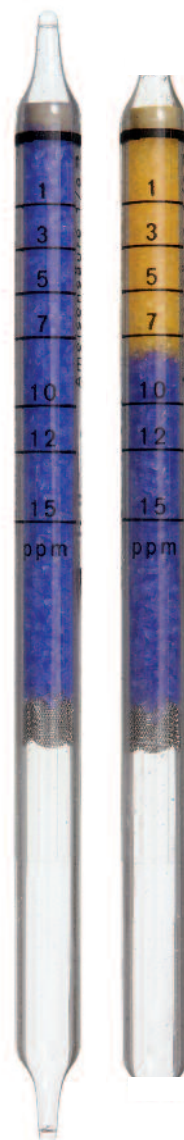

D-13306-2010

Halogenated Hydrocarbons 100/a

Order No. 81 01 601

Application Range

Standard Measuring Range: 200 to 2,600 ppm R 113/R 114
 100 to 1,400 ppm R 11
 200 to 2,800 ppm R 22
 The indication is in mm and must be compared to the calibration data sheets.

Number of Strokes n: 3
 Time for Measurement: approx. 1 min
 Standard Deviation: $\pm 30\%$
 Color Change: blue \rightarrow yellow to greyish green

Ambient Operating Conditions

Temperature: 0 to 40 °C
 Absolute Humidity: 1 to 15 mg H₂O / L

Reaction Principle

For Example:

- a) R113 [pyrolysis] \rightarrow HCl
 b) HCl + pH indicator \rightarrow yellow reaction product

Cross Sensitivity

Other halogenated hydrocarbons, free halogens and hydrogens halides are also indicated, however, with differing sensitivity.
 Perchloroethylene is indicated with the same sensitivity as R113.

Additional Information

The tubes become very warm during the measurement. Therefore, these tubes should not be used in potentially combustible atmospheres. A combustible gas monitor should be used to qualify any questionable area before conducting a measurement with one of these tubes.



ST-199-2001

Hexane 100/a

Order No. 67 28 391

F

Application Range

Standard Measuring Range:	100 to 3,000 ppm
Number of Strokes n:	6
Time for Measurement:	approx. 3 min
Standard Deviation:	± 15 to 20 %
Color Change:	orange → green-brown

Ambient Operating Conditions

Temperature:	15 to 35 °C
Absolute Humidity:	5 to 12 mg H ₂ O / L

Reaction Principle



Cross Sensitivity

Alcohols, esters, aromatics, petroleum hydrocarbons and ethers are also indicated, but with different sensitivities. It is impossible to differentiate between them.

Extension of the Measuring Range

Using $n = 11$, divide the reading by 2; the measuring range will be 50 to 1,500 ppm.



ST-45-2001

Hydrazine 0.01/a

Order No. 81 03 351

Application Range

Standard Measuring Range:	0.01 to 0.4 ppm	/ 0.5 to 6 ppm
Number of Strokes n:	see tube ¹⁾	/ 5
Time for Measurement:	approx. 20 to 30 min	/ approx. 1 min
Standard Deviation:	± 20 to 25 %	
Color Change:	pale grey → grey-brown	

Ambient Operating Conditions

Temperature:	10 to 30 °C
Absolute Humidity:	1 to 20 mg H ₂ O / L

Reaction Principle

N_2H_4 + Silver Salt → grey-brown reaction product

Cross Sensitivity

1.1-Dimethylhydrazin and Monomethylhydrazine are shown with the same sensitivity (Standard Deviation ± 50 %) 5 ppm Ammonia at 100 strokes result in a measurement of approx. 0.01 ppm Hydrazine. At 5 strokes, Ammonia will also not be shown in high concentrations.

¹⁾ Number of strokes is printed on the tube. As a result of manufacturing of processes the number of strokes can vary between 100 and 150 strokes for the low measuring range.

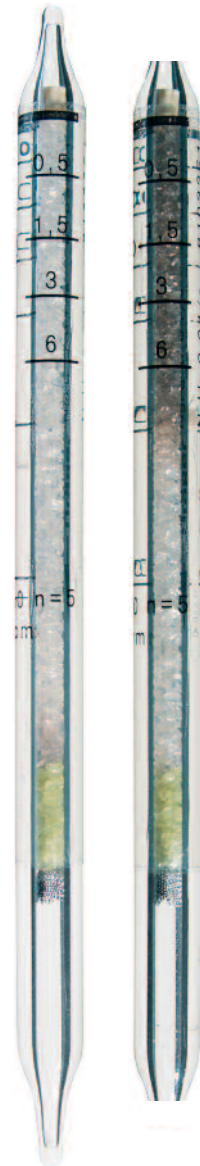

Hydrazine 0.25/a

Order No. CH 31 801

H

Application Range

Standard Measuring Range:	0.25 to 10 / 0.1 to 5 ppm
Number of Strokes n:	10 / 20
Time for Measurement:	approx. 1 min / approx. 2 min
Standard Deviation:	± 10 to 15 %
Color Change:	yellow → blue

Ambient Operating Conditions

Temperature:	10 to 50 °C
Absolute Humidity:	< 20 mg H ₂ O / L

Reaction Principle

$N_2H_4^+$ pH Indicator → blue reaction product

Cross Sensitivity

This tube indicates other basic gases (e.g. organic amines and ammonia), however, with differing sensitivity.

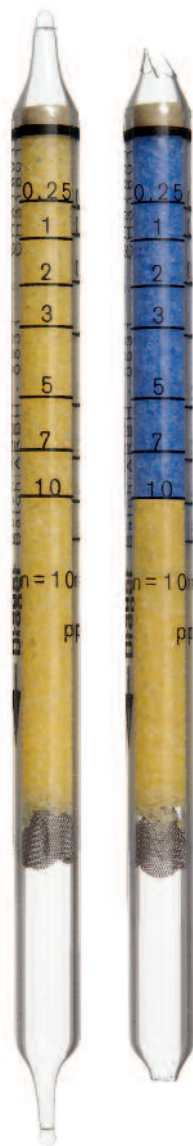

D-13350-2010

Hydrocarbons 2/a

Order No. 81 03 581

Application Range

Standard Measuring Range:	2 to 24 mg / L
Number of Strokes n:	3
Time for Measurement:	approx. 5 min
Standard Deviation:	± 25 %
Color Change:	orange → brown-green

Ambient Operating Conditions

Temperature:	0 to 40 °C
Absolute Humidity:	1 to 25 mg H ₂ O / L

Reaction Principle

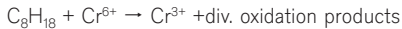

Cross Sensitivity

The information regarding cross sensitivity only applies for measurements with a maximum of 3 strokes. Paraffinic and aromatic hydrocarbons are indicated as a whole. Differentiation is not possible. Aromatic hydrocarbons (benzene, toluene) are also displayed. Their concentration in the mixture should not exceed 20%. There is no fault caused on the display by < 1000 ppm CO.

Additional Information

A maximum of 15 strokes within 1 hour can be performed for leakage measurements (qualitative measurements).

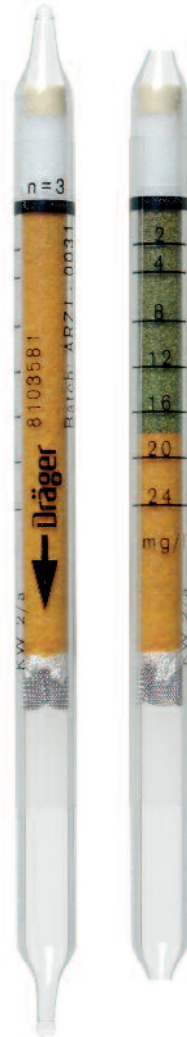

Hydrocarbons 0.1%/c

Order No. 81 03 571

H

Application Range

Standard Measuring Range:	0.1 to 1.3 vol. % propane 0.1 to 1.3 vol. % butane 0.1 to 1.3 vol. % mixture (mix 1:1)
Number of Strokes n:	1
Time for Measurement:	approx. 3 min
Standard Deviation:	± 15 %
Color Change:	orange → brown green

Ambient Operating Conditions

Temperature:	0 to 40 °C
Absolute Humidity:	1 to 40 H ₂ O / L

Reaction Principle

$C_3H_8 / C_4H_{10} + Cr^{6+} \rightarrow Cr^{3+} + \text{div. oxidation products}$

Cross Sensitivity

The information regarding cross sensitivity only applies for measurements with a maximum of 1 stroke. Hydrocarbons, hydrocarbons with olefin double bonds are indicated with different discoloration and sensitivity. No influence on the display of 0.1 vol. % propane/butane at:

- < 99.9 vol. % methane
- < 5 vol. % ethane
- < 1 vol. % carbon monoxide
- < 500 ppm acetylene, ethylene

Additional Information

A maximum of 15 strokes within 1 hour can be performed for leakage measurements (qualitative measurements).



D-5-693-2014

Hydrochloric Acid 0.2/a

Order No. 81 03 481

Application Range

Standard Measuring Range:	0.2 to 3 ppm / 3 to 20 ppm
Number of Strokes n:	10 / 2
Time for Measurement:	approx. 2 min / 0.4 min
Standard Deviation:	± 10 to 15 %
Color Change:	blue → yellow

Ambient Operating Conditions

Temperature:	5 to 40 °C
Absolute Humidity:	≤ 15 mg H ₂ O / L

Reaction Principle

HCl + bromophenol blue → yellow reaction product

Cross Sensitivity

No interference on the reading of 10 ppm H₂S and 2 ppm SO₂. Other acid gases are also indicated, however, with differing sensitivity. Chlorine changes the indicating layer to grey. If chlorine occurs simultaneously, HCl readings will be higher.



ST-561-2008

Hydrochloric Acid 1/a

Order No. CH 29 501

H

Application Range

Standard Measuring Range:	1 to 10 ppm
Number of Strokes n:	10
Time for Measurement:	approx. 2 min
Standard Deviation:	± 10 to 15 %
Color Change:	blue → yellow

Ambient Operating Conditions

Temperature:	5 to 40 °C
Absolute Humidity:	max. 15 mg H ₂ O / L

Reaction Principle

HCl + bromophenol blue → yellow reaction product

Cross Sensitivity

Hydrogen sulfide and sulfur dioxide in the TLV range do not interfere. It is impossible to measure hydrochloric acid in the presence of other mineral acids. Chlorine and nitrogen dioxide are indicated, but with different sensitivities.



ST-114-2001

Hydrochloric Acid 50/a

Order No. 67 28 181

Application Range

Standard Measuring Range:	500 to 5,000 / 50 to 500 ppm
Number of Strokes n:	1 / 10
Time for Measurement:	approx. 30 s / approx. 5 min
Standard Deviation:	± 10 to 15 %
Color Change:	blue → white yellow

Ambient Operating Conditions

Temperature:	10 to 50 °C
Absolute Humidity:	max. 15 mg H ₂ O / L

Reaction Principle

HCl + bromophenol blue → white yellow reaction product

Cross Sensitivity

Hydrogen sulfide and sulfur dioxide do not interfere in the TLV range. It is impossible to measure hydrochloric acid in the presence of other mineral acids. Chlorine and nitrogen dioxide are indicated, but with different sensitivities.

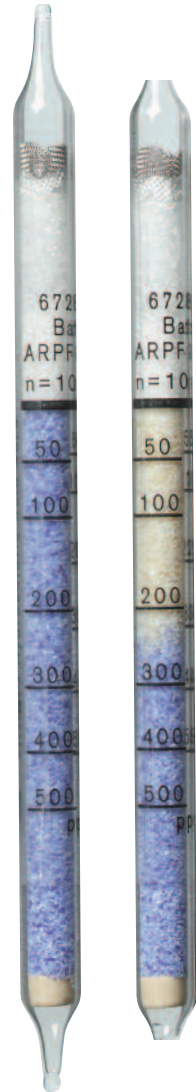

ST-116-2001

Hydrochloric Acid/Nitric Acid 1/a

Order No. 81 01 681

H

Application Range

Standard Measuring Range:

Substance:	Hydrochloric acid:	nitric acid:
Standard Measuring Range:	1 to 10 ppm /	1 to 15 ppm
Number of Strokes n:	10	/ 20
Time for Measurement:	approx. 1.5 min	/ approx. 3 min
Standard Deviation:	± 30 %	
Color Change:	blue → yellow	

Ambient Operating Conditions

Temperature: 5 to 40 °C for HCl

For HNO₃ measurements, the tube scales are applicable only to 20 °C. Where the temperature is different, the measuring result must be multiplied as follows:

Temperature °C	Factor
40	0.3
30	0.4
10	2

Absolute Humidity: max. 15 mg H₂O / L

Reaction Principle

HCl and/or HNO₃ + pH indicator → yellow reaction product

Cross Sensitivity

50 ppm nitrogen dioxide result in almost the same reading as 2 ppm nitric acid. 10 ppm hydrogen sulfide or 5 ppm nitrogen dioxide do not effect the reading. Chlorine concentrations in excess of 1 ppm change the entire indicating layer to a yellow-green.



ST-156-2001

Hydrocyanic Acid 0,5a

Order No. 81 03 601

Application Range

Standard Measuring Range:	0.5 to 5 ppm / 5 to 50 ppm
Number of Strokes n:	10 / 2
Time for Measurement:	approx. 2.5 min. / ca. 0.5 min.
Standard Deviation:	± 10 to 15 %
Color Change:	yellow → red

Ambient Operating Conditions

Temperature:	0 to 40 °C
Absolute Humidity:	< 40 mg H ₂ O / L

Reaction Principle

- $\text{HCN} + \text{HgCl}_2 \rightarrow \text{HCl}$
- $\text{HCl} + \text{methyl red} \rightarrow \text{red reaction product}$

Cross Sensitivity

30 ppm hydrogen sulfide, 300 ppm ammonia, 40 ppm sulfur dioxide, 20 ppm nitrogen dioxide and 1,000 ppm hydrogen chloride do not affect the indication.

Hydrogen sulfide causes the pre-layer to discolor to dark brown. Ammonia concentrations above 300 ppm can cause the indication at the beginning of the indicating layer to discolor back to yellow.

Acylonitrile up to a concentration of 1,000 ppm does not affect the indication.

It is impossible to measure hydrocyanic acid in the presence of phosphine.

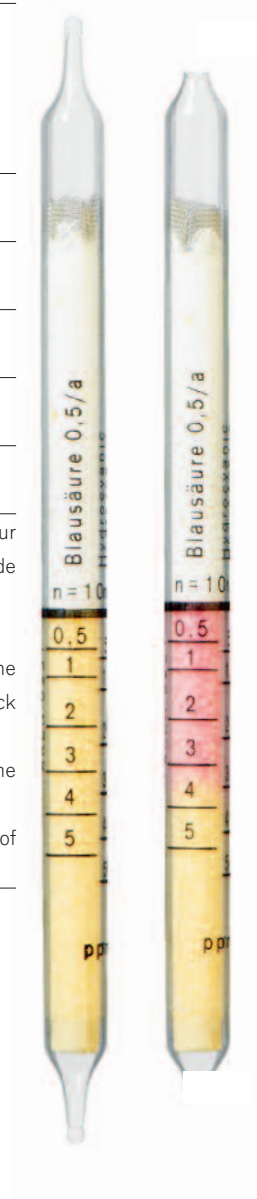

Hydrogen 0.2%/a

Order No. 81 01 511

H

Application Range

Standard Measuring Range:	0.2 to 2.0 vol. %
Number of Strokes n:	1
Time for Measurement:	approx. 1 min
Standard Deviation:	± 15 to 20 %
Color Change:	green yellow → turquoise blue

Ambient Operating Conditions

Temperature:	20 to 40 °C
Absolute Humidity:	max. 50 mg H ₂ O / L

Reaction Principle

- $\text{H}_2 + \frac{1}{2} \text{O}_2 \rightarrow \text{H}_2\text{O}$
- $\text{H}_2\text{O} + \text{indicator} \rightarrow \text{turquoise blue reaction product}$

Cross Sensitivity

- No interference by:
- 0.1 vol. % acetylene
 - 6 vol. % alcohol
 - 6 vol. % ammonia
 - 0.5 vol. % carbon monoxide

Additional Information

The indicating layer is heated up by hydrogen concentrations of more than 10 vol. %. The air sample must not contain additional flammable substances whose ignition temperature is below 250 °C/ 482 °F as this will cause an explosion risk.



ST-166-2001

Hydrogen 0.5%/a

Order No. CH 30 901

Application Range

Standard Measuring Range:	0.5 to 3.0 vol. %
Number of Strokes n:	5
Time for Measurement:	approx. 1 min
Standard Deviation:	± 10 to 15 %
Color Change:	yellow-green → pink

Ambient Operating Conditions

Temperature:	5 to 40 °C
Absolute Humidity:	< 30 mg H ₂ O / L

Reaction Principle

- a) $\text{H}_2 + \frac{1}{2} \text{O}_2 \rightarrow \text{H}_2\text{O}$
 b) $\text{H}_2\text{O} + \text{SeO}_2 + \text{H}_2\text{SO}_4 \rightarrow \text{pink reaction product}$

Cross Sensitivity

Up to 1,000 ppm CO has no influence on the indication; higher concentrations lead to lower measurement results. Acetylene and alcohols react similarly to hydrogen.

Additional Information

Do not use in potentially explosive areas. Qualify before use with a combustible gas monitor. When the hydrogen concentration is above 3 vol. % the catalysis layer heats up during the measurement with a reddish glow.

Determination of hydrogen in air with at least 5 vol. % O₂.



ST-170-2001

Hydrogen Fluoride 0.5/a

Order No. 81 03 251

H

Application Range

Standard Measuring Range:	0.5 to 15 ppm	/ 10 to 90 ppm
Number of Strokes n:	10	/ 2
Time for Measurement:	approx. 2 min	/ approx. 25 s
Standard Deviation:	± 20 to 30 %	
Color Change:	blue violet → yellow	

Ambient Operating Conditions

Temperature:	10 to 40 °C
Absolute Humidity:	30 to 80 %

Reaction Principle

HF + pH indicator → yellow reaction product

Cross Sensitivity

Other mineral acids, e.g. hydrochloric acid or nitric acid, are indicated. Alkaline gases, e.g. ammonia, causes minus results or prevents an indication.

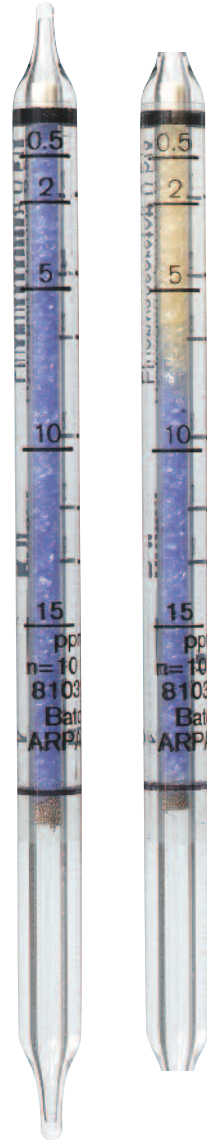

ST-62-2001

Hydrogen Fluoride 1.5/b

Order No. CH 30 301

Application Range

Standard Measuring Range:	1.5 to 15 ppm
Number of Strokes n:	20
Time for Measurement:	approx. 2 min
Standard Deviation:	± 15 to 20 %
Color Change:	pale blue → pale pink

Ambient Operating Conditions

Temperature:	15 to 30 °C
Absolute Humidity:	max. 9 mg H ₂ O / L

Reaction Principle



Cross Sensitivity

In the presence of higher humidity (> 9 mg H₂O / L), hydrogen fluoride mist is generated, which cannot be quantitatively indicated by the detector tube (i.e. the indication is too low). Other halogenated hydrocarbons in the TLV range do not interfere.

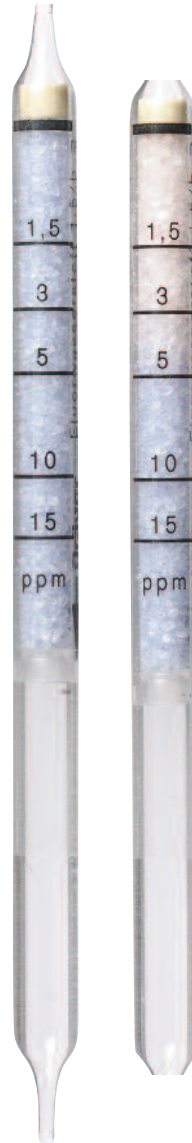

ST-63-2001

Hydrogen Peroxide 0.1/a

Order No. 81 01 041

H

Application Range

Standard Measuring Range:	0.1 to 3 ppm
Number of Strokes n:	20
Time for Measurement:	approx. 3 min
Standard Deviation:	± 10 to 15 %
Color Change:	white → brown

Ambient Operating Conditions

Temperature:	10 to 25 °C
Absolute Humidity:	3 to 10 mg H ₂ O / L

Reaction Principle

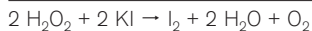

Cross Sensitivity

It is impossible to measure hydrogen peroxide in the presence of chlorine or nitrogen dioxide. Only hydrogen peroxide vapor is indicated, not the aerosols.



D-5445-2014

Hydrogen Sulfide 0.2/a

Order No. 81 01 461

Application Range

Standard Measuring Range:	0.2 to 5 ppm
Number of Strokes n:	10
Time for Measurement:	approx. 5 min
Standard Deviation:	± 5 to 10 %
Color Change:	white → pale brown

Ambient Operating Conditions

Temperature:	10 to 30 °C
Absolute Humidity:	3 to 15 mg H ₂ O / L

Reaction Principle



Cross Sensitivity

Sulfur dioxide and hydrochloric acid in the TLV range do not interfere.

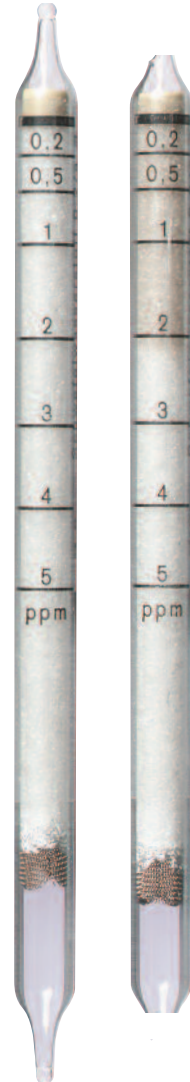

ST-192-2001

Hydrogen Sulfide 0.2/b

Order No. 81 01 991

H

Application Range

Standard Measuring Range:	0.2 to 6 ppm
Number of Strokes n:	1
Time for Measurement:	approx. 55 s
Standard Deviation:	± 15 to 20 %
Color Change:	yellow → pink

Ambient Operating Conditions

Temperature:	15 to 40 °C
In case of temperature between 0 °C and 10 °C, the reading has to be multiplied by 1.5; standard deviation: ± 30%.	
Absolute Humidity:	max. 20 mg H ₂ O / L

Reaction Principle

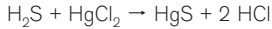

HCL + pH indicator → pink reaction product

Cross Sensitivity

Up to 1000 ppm, sulfur dioxide has no influence on the reading. Within the range of their TLV, mercaptanes, arsine, phosphine and nitrogen dioxide are also indicated, however, with differing sensitivity. Within its TLV, hydrogen cyanide changes the color of the entire indicating layer to a light orange. The reading of hydrogen sulfide is not affected.

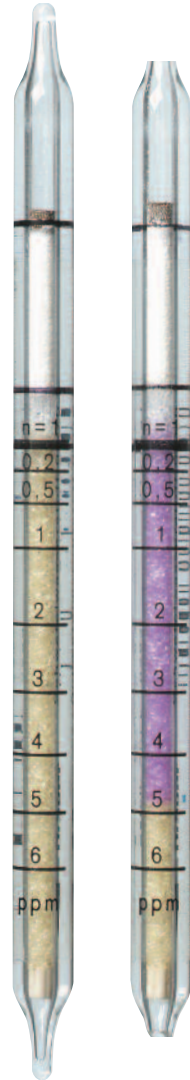

ST-127-2001

Hydrogen Sulfide 0.5/a

Order No. 67 28 041

Application Range

Standard Measuring Range:	0.5 to 15 ppm
Number of Strokes n:	10
Time for Measurement:	approx. 6 min
Standard Deviation:	± 5 to 10 %
Color Change:	white → pale brown

Ambient Operating Conditions

Temperature:	0 to 40 °C
Absolute Humidity:	3 to 30 mg H ₂ O / L

Reaction Principle



Cross Sensitivity

No interference by:	100 ppm sulfur dioxide
	100 ppm hydrochloric acid
	100 ppm ethyl mercaptan



ST-126-2001

Hydrogen Sulfide 1/c

Order No. 67 19 001

H

Application Range

Standard Measuring Range:	10 to 200	/ 1 to 20 ppm
Number of Strokes n:	1	/ 10
Time for Measurement:	approx. 20 sec./ approx. 3 min	
Standard Deviation:	± 5 to 10 %	
Color Change:	white → pale brown	

Ambient Operating Conditions

Temperature:	0 to 40 °C
Absolute Humidity:	max. 30 mg H ₂ O / L

Reaction Principle



Cross Sensitivity

Should sulfur dioxide occur simultaneously in concentrations well above their TLV, this may result in plus errors of up to 50%. Sulfur dioxide alone is not indicated.



ST-130-2001

Hydrogen Sulfide 1/d

Order No. 81 01 831

Application Range

Standard Measuring Range:	10 to 200	/ 1 to 20 ppm
Number of Strokes n:	1	/ 10
Time for Measurement:	approx. 1 min	/ approx. 10 min
Standard Deviation:	± 15 %	
Color Change:	white → brown	

Ambient Operating Conditions

Temperature:	2 to 40 °C
Absolute Humidity:	max. 40 mg H ₂ O / L

Reaction Principle

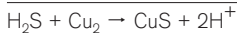

Cross Sensitivity

500 ppm hydrochloric acid, 500 ppm sulfur dioxide, 500 ppm ammonia or 100 ppm arsine do not interfere with the reading. Methyl mercaptan and ethyl mercaptan change the entire indicating layer to a pale yellow. When mixed with hydrogen sulfide, the reading is extended by approx. 30%.

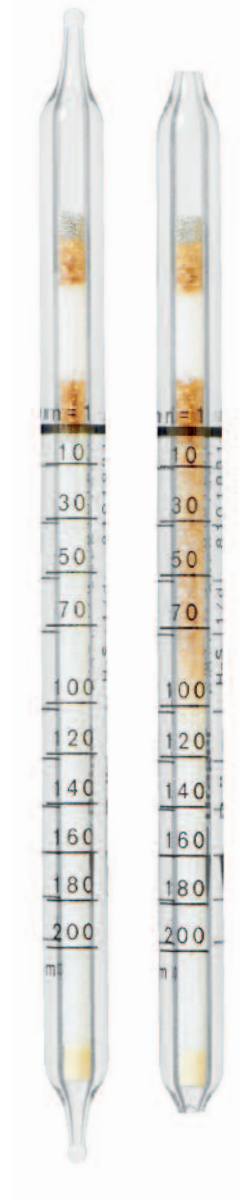

Hydrogen Sulfide 2/a

Order No. 67 28 821

H

Application Range

Standard Measuring Range:	20 to 200	/ 2 to 20 ppm
Number of Strokes n:	1	/ 10
Time for Measurement:	approx. 20 s	/ approx. 3.5 min
Standard Deviation:	± 5 to 10 %	
Color Change:	white → pale brown	

Ambient Operating Conditions

Temperature:	0 to 40 °C
Absolute Humidity:	3 to 30 mg H ₂ O / L

Reaction Principle

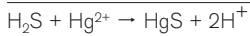

Cross Sensitivity

No interference by:	200 ppm sulfur dioxide
	100 ppm hydrochloric acid
	100 ppm ethyl mercaptan

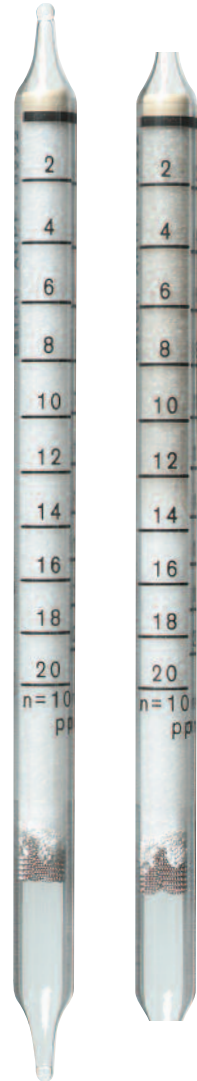

Hydrogen Sulfide 2/b

Order No. 81 01 961

Application Range

Standard Measuring Range:	2 to 60 ppm
Number of Strokes n:	1
Time for Measurement:	approx. 30 s
Standard Deviation:	± 5 to 10 %
Color Change:	white → pale brown

Ambient Operating Conditions

Temperature:	0 to 40 °C
Absolute Humidity:	max. 20 mg H ₂ O / L

Reaction Principle



Cross Sensitivity

Hydrochloric acid, mercaptan and sulfur dioxide in the TLV range does not interfere.

Extension of the Measuring Range

Using n = 2, divide the reading by 2; the measuring range will be 1 to 30 ppm.

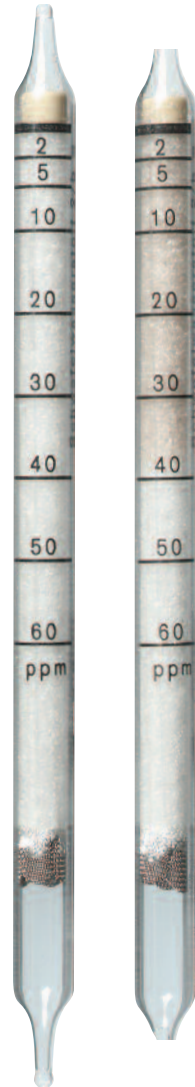

ST-128-2001

Hydrogen Sulfide 5/b

Order No. CH 29 801

H

Application Range

Standard Measuring Range:	5 to 60 ppm
Number of Strokes n:	10
Time for Measurement:	approx. 4 min
Standard Deviation:	± 5 to 10 %
Color Change:	white → brown

Ambient Operating Conditions

Temperature:	0 to 60 °C
Absolute Humidity:	< 40 mg H ₂ O / L

Reaction Principle



Cross Sensitivity

Sulfur dioxide can cause plus errors of up to 50%. Sulfur dioxide alone does not discolor the indicating layer.

Extension of the Measuring Range

Using n = 1, multiply the reading by 10; the measuring range will be 50 to 600 ppm.



ST-125-2001

Hydrogen Sulfide 100/a

Order No. CH 29 101

Application Range

Standard Measuring Range:	100 to 2,000 ppm
Number of Strokes n:	1
Time for Measurement:	approx. 30 s
Standard Deviation:	± 5 to 10 %
Color Change:	white → brown

Ambient Operating Conditions

Temperature:	0 to 40 °C
Absolute Humidity:	3 to 40 mg H ₂ O / L

Reaction Principle



Cross Sensitivity

No interference by:	2,000 ppm sulfur dioxide
	100 ppm nitrogen dioxide



ST-128-2001

Hydrogen Sulfide 0.2%/A

Order No. CH 28 101

H

Application Range

Standard Measuring Range:	0.2 to 7 vol. %
Number of Strokes n:	1 + 2 desorption strokes in clean air
Time for Measurement:	approx. 2 min
Standard Deviation:	± 5 to 10 %
Color Change:	pale blue → black

Ambient Operating Conditions

Temperature:	0 to 60 °C
Absolute Humidity:	max. 40 mg H ₂ O / L

Reaction Principle



Cross Sensitivity

In the presence of sulfur dioxide, the indicating layer can change to a yellowish color, but the hydrogen sulfide measurement is not affected. Comparable concentrations of mercaptan will interfere with the reading.



Hydrogen Sulfide 2%/a

Order No. 81 01 211

Application Range

Standard Measuring Range:	2 to 40 vol. %
Number of Strokes n:	1
Time for Measurement:	approx. 1 min
Standard Deviation:	± 5 to 10 %
Color Change:	pale blue → black

Ambient Operating Conditions

Temperature:	0 to 40 °C
Absolute Humidity:	3 to 20 mg H ₂ O / L

Reaction Principle

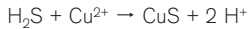

Cross Sensitivity

No interference by:	5,000 ppm sulfur dioxide
	1,000 ppm hydrochloric acid
	1,000 ppm ethyl mercaptan



D-13319-2010

Hydrogen Sulfide + Sulfur Dioxide 0.2%/A

Order No. CH 28 201

H

Application Range

Standard Measuring Range:	0.2 to 7 vol. %
Number of Strokes n:	1 + 2 desorption strokes in clean air
Time for Measurement:	approx. 2 min
Standard Deviation:	± 5 to 10 %
Color Change:	brown → bright yellow

Ambient Operating Conditions

Temperature:	0 to 40 °C
Absolute Humidity:	max. 40 mg H ₂ O / L

Reaction Principle

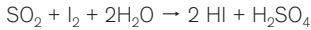
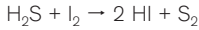

Cross Sensitivity

All substances oxidized by iodine are indicated, but with different sensitivities. It is impossible to measure hydrogen sulfide and sulfur dioxide in the presence of such substances.

Extension of the Measuring Range

Using $n = 10$, divide the reading by 10; the measuring range will be 0.02 to 0.7 vol. %.



D-13349-2010

Iodine 0.1/a

Order No. 81 03 521

Application Range

Standard Measuring Range:	0.1 to 0.6 ppm / 1 to 5 ppm
Number of Strokes n:	5 / 1
Time for Measurement:	approx. 5 min / approx. 1 min
Standard Deviation:	± 15 to 20 %
Color Change:	yellow → pink

Ambient Operating Conditions

Temperature:	15 to 40 °C
Absolute Humidity:	≤ 20 mg H ₂ O / L

Reaction Principle

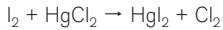

Cross Sensitivity

Mercaptans, arsine, phosphine and nitrogen dioxide are displayed with varying sensitivities. 10 ppm hydrocyanic acid changes the color of the entire indicating layer to a light orange.

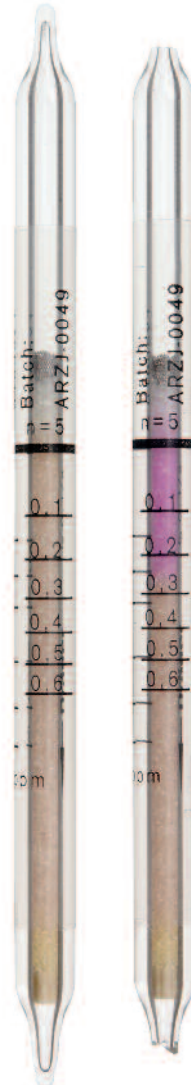

D-13339-2010

Mercaptan 0.1/a

Order No. 81 03 281

H

Application Range

Standard Measuring Range:	0.1 to 2.5 ppm	/ 3 to 15 ppm
Number of Strokes n:	10	/ 2
Time for Measurement:	approx. 3 min	/ approx. 40 s
Standard Deviation:	± 10 to 15 %	
Color Change:	yellow → red	

Ambient Operating Conditions

Temperature:	5 to 40 °C
Absolute Humidity:	2 to 40 mg H ₂ O / L

Reaction Principle

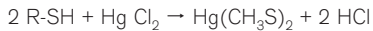

HCl + pH-indicator → reddish reaction product

Cross Sensitivity

Propyl mercaptan and n-butyl-mercaptan are indicated, but with different sensitivities. 4 ppm ethylene, 30 ppm CO, 10 ppm tetrahydrothiophene and 100 ppm hydrogen sulfide do not affect the indication. Hydrogen sulfide changes the pre-layer to black.

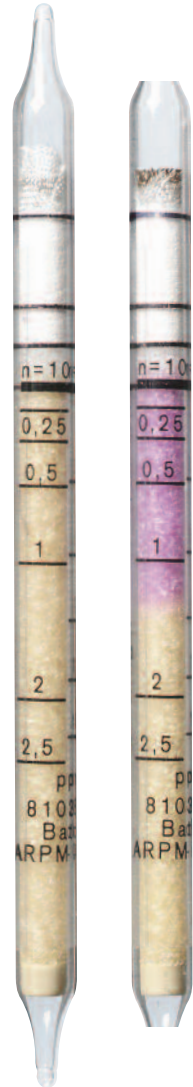

ST-180-2001

Mercaptan 0.5/a

Order No. 67 28 981

Application Range

Standard Measuring Range:	0.5 to 5 ppm
Number of Strokes n:	20
Time for Measurement:	approx. 5 min.
Standard Deviation:	± 10 to 15 %
Color Change:	white → yellow

Ambient Operating Conditions

Temperature:	10 to 40 °C
Absolute Humidity:	3 to 15 mg H ₂ O / L

Reaction Principle



Cross Sensitivity

Higher molecular weight alkyl mercaptans (e.g. propyl- and butylmercaptans) are indicated with approximately the same sensitivity. 1,000 ppm ethylene, 2,000 ppm carbon monoxide and 200 ppm hydrogen sulfide do not affect the indication. Hydrogen sulfide discolors the pre-layer black.



ST-58-2001

Mercaptan 20/a

Order No. 81 01 871

Application Range

Standard Measuring Range:	20 to 100 ppm
Number of Strokes n:	10
Time for Measurement:	approx. 2.5 min
Standard Deviation:	± 10 to 15 %
Color Change:	white → yellow brown

Ambient Operating Conditions

Temperature:	0 to 50 °C
Absolute Humidity:	3 to 30 mg H ₂ O / L

Reaction Principle

- $2 \text{R-SH} + \text{Cu}^{2+} \rightarrow \text{Cu}(\text{RS})_2 + 2 \text{H}^+$
- $\text{Cu}(\text{RS})_2 + \text{S} \rightarrow \text{yellow brown copper compound}$

Cross Sensitivity

Higher molecular weight alkyl mercaptans (e.g. propyl- and butylmercaptans) are indicated with approximately the same sensitivity.

Hydrogen sulfide is indicated with approximately twice the sensitivity of the mercaptans (e.g. 10 ppm hydrogen sulfide gives an indication of 20 ppm). In presence of Hydrogen Sulfide a measurement of mercaptans is impossible.

Additional Information

After performing the required ten pump strokes the reagent ampoule must be broken. The liquid of the ampoule must be transferred to the indicating layer and carefully drawn through it using the pump. After completing the measurement wait for 3 min prior to evaluation.



ST-57-2001

Mercury Vapor 0.1/b

Order No. CH 23 101

Application Range

Standard Measuring Range:	0.05 to 2 mg/m ³
Number of Strokes n:	40 to 1
Time for Measurement:	max. 10 min
Standard Deviation:	± 30 %
Color Change:	pale yellow grey → pale orange

Ambient Operating Conditions

Temperature:	0 to 40 °C
Absolute Humidity:	< 20 mg H ₂ O / L

Reaction Principle

$\text{Hg} + \text{CuI} \rightarrow \text{Cu-Hg-complex}$

Cross Sensitivity

Free halogens cause substantial minus errors. It is impossible to measure mercury vapor in the presence of halogens. Arsine, phosphine, hydrogen sulfide, ammonia, nitrogen dioxide, sulfur dioxide and hydrazine in the TLV range do not interfere.



D-5459-2014

Methyl Acrylate 5/a

Order No. 67 28 161

M

Application Range

Standard Measuring Range:	5 to 200 ppm
Number of Strokes n:	20
Time for Measurement:	approx. 5 min
Standard Deviation:	± 30 to 40 %
Color Change:	yellow → blue

Ambient Operating Conditions

Temperature:	15 to 35 °C
Absolute Humidity:	5 to 12 mg H ₂ O / L

Reaction Principle

$\text{CH}_2=\text{CH}-\text{COOCH}_3 + \text{Pd-Molybdate complex} \rightarrow \text{blue reaction product}$

Cross Sensitivity

Other compounds with C=C double bonds are indicated, but with different sensitivities. It is impossible to differentiate between them. It is impossible to measure methyl acrylate in the presence of hydrogen sulfide. Hydrogen sulfide will discolor the indicating layer black. Carbon monoxide in high concentrations discolors the indicating layer pale blue grey.

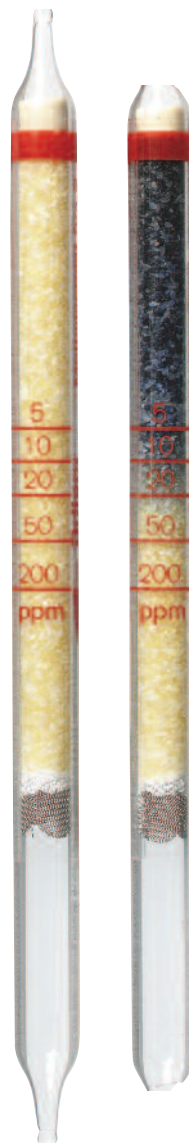

ST-60-2001

Methyl Bromide 0.2/a

Order No. 81 03 391

Application Range

Standard Measuring Range:	0.2 to 2 ppm	/ 2 to 8 ppm
Reverse activation (n)	1 (1A)	/ 1 (1A)
Number of Strokes n:	5	/ 2
Time for Measurement:	approx. 8 min.	/ approx. 4 min.
Standard Deviation:	± 15 to 20 %	
Color Change:	light color → green	

Ambient Operating Conditions

Temperature:	2 to 40 °C
Absolute Humidity:	< 20 mg/L

Reaction Principle

$\text{CH}_3\text{Br} + \text{H}_2\text{S}_2\text{O}_7 + \text{chromate} \rightarrow \text{Br}_2$

$\text{Br}_2 + \text{o-tolidine} \rightarrow \text{green reaction product}$

Cross Sensitivity

Vinyl chloride or carbon tetrachloride: < 2 ppm no indication. Methyl bromide cannot be measured in the presence of perchloroethylene or trichloroethylene. Sulfuryl fluoride, phosphine, ethylene oxide, ammonia, hydrocyanic acid, chloropicrin and formaldehyde below their AGW/TLV values are not indicated. Ethylene dibromide is indicated with 1.2 times its sensitivity.

Additional Informations

One reverse activationstroke with air or gas sample



Methyl Bromide 0.5/a

Order No. 81 01 671

M

Application Range

Standard Measuring Range:	5 to 30	/ 0.5 to 5 ppm
Number of Strokes n:	2	/ 8
Time for Measurement:	approx. 2 min	/ approx. 5 min
Standard Deviation:	± 15 to 20 %	
Color Change:	white → blue green	

Ambient Operating Conditions

Temperature:	2 to 40 °C
Absolute Humidity:	max. 20 mg H ₂ O / L

Reaction Principle

- a) $\text{CH}_3\text{Br} + \text{H}_2\text{S}_2\text{O}_7 \rightarrow \text{HBr}$
 b,) $\text{HBr} + \text{Cr}^{\text{VI}} \rightarrow \text{Br}_2$
 b) $\text{Br}_2 + \text{o-tolidine} \rightarrow \text{blue green reaction product}$

Cross Sensitivity

Vinyl chloride:	2 ppm no reading.
Carbon tetrachloride:	2 ppm no reading
Perchloroethylene and Trichloroethylene:	5 ppm changes the indicating layer to a light yellow.
1,2-dichloroethylene:	20 ppm result in a reading of approx. 3 ppm.
1,1-dichloroethylene:	up to 2 ppm the sensitivity is the same as with methyl bromide.



D-5449-2014

Methyl Bromide 3/a

Order No. 67 28 211

Application Range

Standard Measuring Range:	10 to 100 / 3 to 35 ppm
Number of Strokes n:	5 activation strokes in methyl bromide free air before testing. 2 / 5
Time for Measurement:	approx. 1 min / approx. 2.5 min
Standard Deviation:	± 10 to 15 %
Color Change:	pale grey green → blue grey

Ambient Operating Conditions

Temperature:	0 to 40 °C
Absolute Humidity:	5 to 12 mg H ₂ O / L

Reaction Principle

- $\text{CH}_3\text{Br} + \text{H}_2\text{S}_2\text{O}_7 \rightarrow$ gaseous cleavage product
- Gaseous cleavage product + $\text{KMnO}_4 \rightarrow \text{Br}_2$
- $\text{Br}_2 + \text{Diphenylbenzidine} \rightarrow$ blue grey reaction product

Cross Sensitivity

Other chlorinated hydrocarbons are indicated, but with different sensitivities.



ST-5752-2004

Methyl Bromide 5/b

Order No. CH 27 301

M

Application Range

Standard Measuring Range:	5 to 50 ppm
Number of Strokes n:	5
Time for Measurement:	approx. 1 min.
Standard Deviation:	± 20 to 30 %
Color Change:	green → brown

Ambient Operating Conditions

Temperature:	0 to 40 °C
Absolute Humidity:	3 to 15 mg H ₂ O / L

Reaction Principle

- $\text{CH}_3\text{Br} + \text{SO}_3 + \text{MnO}_4^- \rightarrow \text{Br}_2$
- $\text{Br}_2 + \text{o-dianisidine} \rightarrow \text{brown reaction product}$

Cross Sensitivity

Other chlorinated hydrocarbons, free halogens and halogenated hydrocarbon acids are also indicated, however, with differing sensitivities.



Methylene Chloride 20/a

Order No. 81 03 591

Application Range

Standard Measuring Range:	20 to 200 ppm
Number of Strokes n:	8
Time for Measurement:	approx. 7 min.
Standard Deviation:	± 15 to 25 %
Color Change:	yellow → red

Ambient Operating Conditions

Temperature:	17 to 30 °C At 25 °C to 30 °C/77 °F to 86 °F multiply the reading with the factor 0.6.
Absolute Humidity:	3 to 25 mg H ₂ O / L

Reaction Principle

- $\text{CH}_2\text{Cl}_2 + \text{chromate} \rightarrow \text{Cl}_2$
- $\text{Cl}_2 + \text{amine} \rightarrow \text{red reaction product}$

Cross Sensitivity

100 ppm n-octane and 300 ppm carbon monoxide do not interfere the reading. In case of concentrations > 100 ppm n-octane, methylene chloride is not indicated. Other chlorinated hydrocarbons will be indicated.

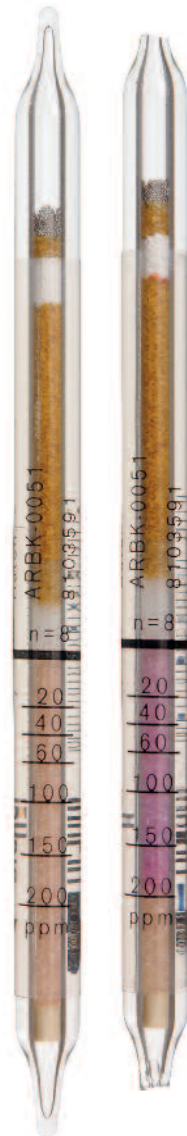

Methylisothiocyanate 0.1/a

Order No. 81 03 485

M

Application Range

Standard Measuring Range:	0.2 to 6 ppm / 0.1 to 1.2 ppm
Number of Strokes n:	6 / 20
Time for Measurement:	approx. 60 s / 200 s
Standard Deviation:	± 10 to 15 %
Color Change:	yellow → brownish-grey

Ambient Operating Conditions

Temperature:	0 to 50 °C
Absolute Humidity:	≤ 55 mg H ₂ O / L

Reaction Principle

Methylisothiocyanate + Palladium sulfate → brownish-grey reaction product

Cross Sensitivity

20 ppm methyl bromide and 20 ppm chloropicrine are not indicated.

Use the following factors to correct the temperature and humidity dependence:

Temp [°C / °F]	0 / 32	20 / 68	50 / 122
rel. humidity [%]			
5	1.4	1	0.9
50	1.2	1	0.9
90	1.2	1	-

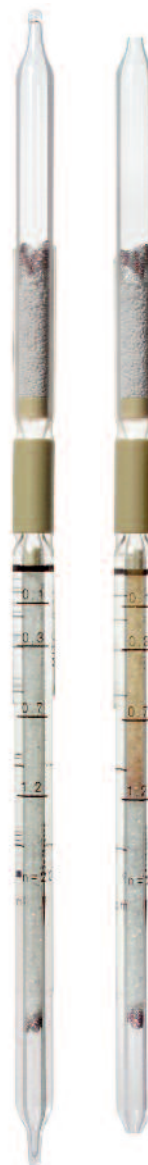

Natural Gas Test

Order No. CH 20 001

Application Range

Standard Measuring Range:	Qualitative determination of natural gas
Number of Strokes n:	5
Time for Measurement:	approx. 100 s
Standard Deviation:	50 %
Color Change:	white → brown green to grey violet

Ambient Operating Conditions

Temperature:	0 to 50 °C
Absolute Humidity:	max. 40 mg H ₂ O / L

Reaction Principle

- a) $\text{CH}_4 + \text{KMnO}_4 + \text{H}_2\text{S}_2\text{O}_7 \rightarrow \text{CO}$
 b) $\text{CO} + \text{I}_2\text{O}_5 \rightarrow \text{I}_2 + \text{CO}_2$

Cross Sensitivity

Due to the reaction principle a number of other organic compounds such as propane and butane are indicated as well. Carbon monoxide is also indicated. It is not possible to differentiate between different compounds.

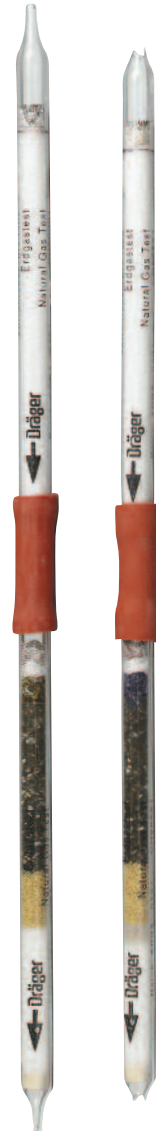

ST-187-2001

Nickel Tetracarbonyl 0.1/a

Order No. CH 19 501

M

Application Range

Standard Measuring Range:	0.1 to 1 ppm Discoloration compared to color standard.
Number of Strokes n:	20
Time for Measurement:	approx. 5 min
Standard Deviation:	± 50 %
Color Change:	yellow → pink

Ambient Operating Conditions

Temperature:	0 to 30 °C
Absolute Humidity:	< 30 mg H ₂ O / L

Reaction Principle

- $\text{Ni}(\text{CO})_4 + \text{I}_2 \rightarrow \text{NiI}_2 + 4 \text{CO}$
- $\text{NiI}_2 + \text{Dimethylglyoxime} \rightarrow \text{pink colored complex}$

Cross Sensitivity

Iron pentacarbonyl is also indicated by a brownish discoloration, however, with less sensitivity. Measurement of nickel tetra carbonyl is not possible in the presence of hydrogen sulfide or sulfur dioxide, since the reading is suppressed. Such a disturbance can be recognised by decoloration of the indicating layer even before the reagent ampoule is opened.

Additional Information

After performing the required 20 pump strokes the reagent ampoule must be broken and the liquid carefully drawn onto the indicating layer using the pump.



ST-74-2001

Nitric Acid 1/a

Order No. 67 28 311

Application Range

Standard Measuring Range:	5 to 50	/ 1 to 15 ppm
Number of Strokes n:	10	/ 20
Time for Measurement:	approx. 2 min	/ approx. 4 min
Standard Deviation:	± 10 to 15 %	
Color Change:	blue → yellow	

Ambient Operating Conditions

Temperature:	5 to 40 °C
Absolute Humidity:	3 to 15 mg H ₂ O / L

Reaction Principle

$\text{HNO}_3 + \text{bromophenol blue} \rightarrow \text{yellow reaction product}$

Cross Sensitivity

Hydrogen sulfide and nitrogen dioxide in the TLV range do not interfere, however, 50 ppm nitrogen dioxide gives an indication similar to 3 ppm nitric acid. It is impossible to measure nitric acid in the presence of other mineral acids. Chlorine discolors the indication layer grey, and this makes it difficult to evaluate the nitric acid indication. If chlorine is present in the TLV range, this leads to slightly higher nitric acid indications.

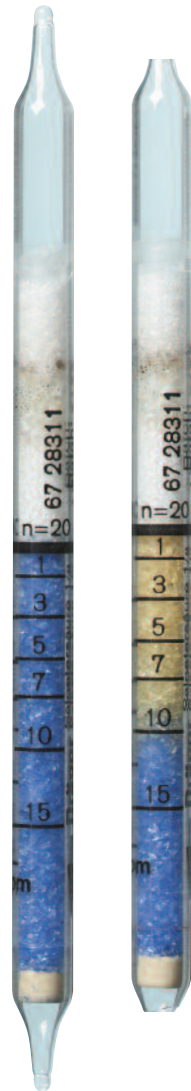

Nitrogen Dioxide 0.1/a

Order No. 81 03 631

N

Application Range

Standard Measuring Range:	5 to 30 ppm / 0.1 to 5 ppm
	The first scale line on the tube's scale equals 0.1 ppm.
Number of Strokes n:	1 / 5
Time for Measurement:	approx. 15 s / approx. 75 s
Standard Deviation:	± 10 to 15 %
Color Change:	grey-green → blue-grey

Ambient Operating Conditions

Temperature:	0 to 40 °C
Absolute Humidity:	< 40 mg H ₂ O / L

Reaction Principle

$\text{NO}_2 + \text{diphenylbenzidine} \rightarrow \text{blue-grey reaction product}$

Cross Sensitivity

Chlorine and ozone are also indicated, but with different sensitivities. Nitrogen monoxide is not indicated. NO₂ concentrations above 400 ppm result in the display bleaching out.

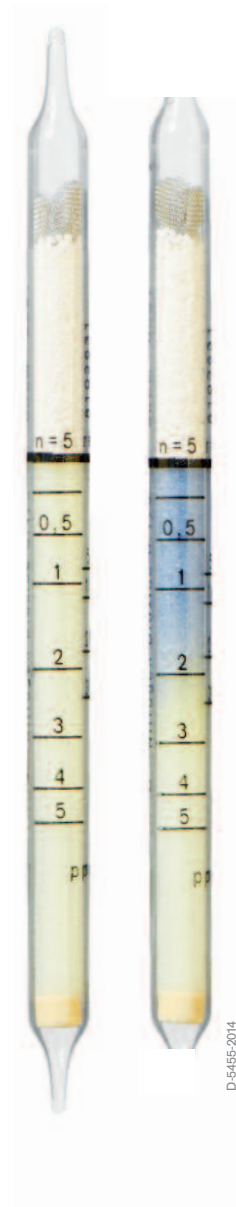

D-5465-2014

Nitrogen Dioxide 2/c

Order No. 67 19 101

Application Range

Standard Measuring Range: 5 to 100 ppm / 2 to 50 ppm

Number of Strokes n: 5 / 10

Time for Measurement: approx. 1 min / approx. 2 min

Standard Deviation: ± 10 to 15 %

Color Change: yellow green \rightarrow blue grey

Ambient Operating Conditions

Temperature: 10 to 40 °C

Absolute Humidity: max. 30 mg H₂O / L

Reaction Principle

NO₂ + diphenylbenzidine \rightarrow blue grey reaction product

Cross Sensitivity

Within their TLV, ozone or chlorine do not interfere with the reading. Higher concentrations are indicated, however with differing sensitivity period. Nitrogen monoxide is not indicated.

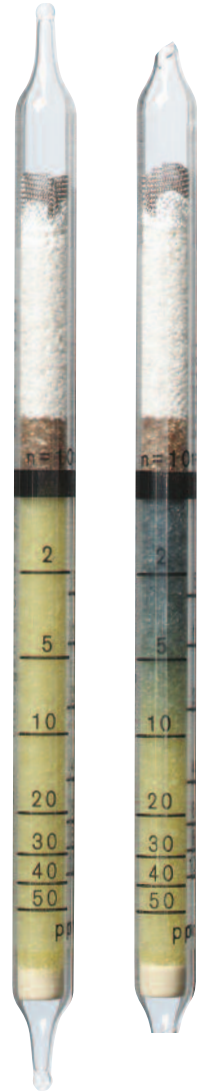

ST-140-2001

Nitrous Fumes 0.2/a

Order No. 81 03 661

N

Application Range

Standard Measuring Range:	0.2 to 6 ppm / 5 to 30 ppm
Number of Strokes n:	5 / 2
Time for Measurement:	approx. 75 sec. / approx. 30 sec.
Standard Deviation:	± 10... 15 % / ± 20... 25 %
Color Change:	grey-green → blue grey

Ambient Operating Conditions

Temperature:	10 to 40 °C
Absolute Humidity:	3 to 40 mg H ₂ O / L

Reaction Principle

- $\text{NO} + \text{Ox} \rightarrow \text{NO}_2$
- $\text{NO}_2 + \text{diphenylbenzidine} \rightarrow \text{blue grey reaction product}$

Cross Sensitivity

In case of nitrogen dioxide in concentrations above 300 ppm the indication layer can bleach. Chlorine and ozone are indicated as well, but with different sensitivities and may falsify the measurement results.

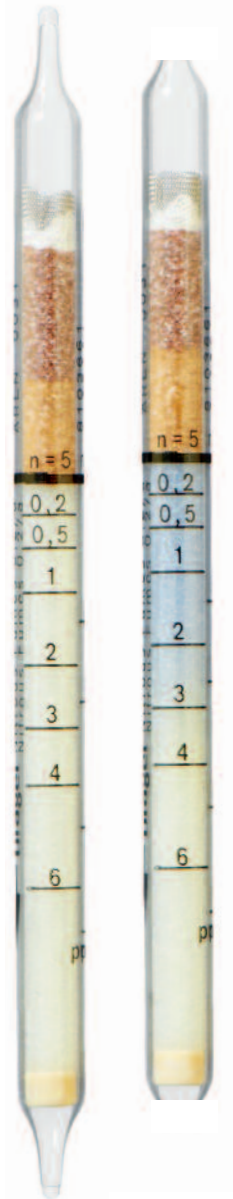

Nitrous Fumes 2/a

Order No. CH 31 001

Application Range

Standard Measuring Range:	5 to 100	/ 2 to 50 ppm
Number of Strokes n:	5	/ 10
Time for Measurement:	approx. 1 min / approx. 2 min	
Standard Deviation:	± 10 to 15 %	
Color Change:	yellow → blue grey	

Ambient Operating Conditions

Temperature:	10 to 30 °C
Absolute Humidity:	max. 30 mg H ₂ O / L

Reaction Principle

- $\text{NO} + \text{Cr}^{\text{VI}} \rightarrow \text{NO}_2$
- $\text{NO}_2 + \text{o-diphenylbenzidine} \rightarrow \text{blue grey reaction product}$

Cross Sensitivity

Chlorine and ozone are indicated with different sensitivities.



Nitrous Fumes 20/a

Order No. 67 24 001

N

Application Range

Standard Measuring Range:	20 to 500 ppm
Number of Strokes n:	2
Time for Measurement:	approx. 30 s
Standard Deviation:	± 10 to 15 %
Color Change:	grey → red brown

Ambient Operating Conditions

Temperature:	15 to 40 °C
Absolute Humidity:	max. 40 mg H ₂ O / L

Reaction Principle

- $\text{NO} + \text{Cr}^{\text{VI}} \rightarrow \text{NO}_2$
- $\text{NO}_2 + \text{o-dianisidine} \rightarrow \text{red brown reaction product}$

Cross Sensitivity

There is no influence of chlorine and ozone, if these gases are in range of their TLVs. Higher concentrations are indicated with different sensitivities.

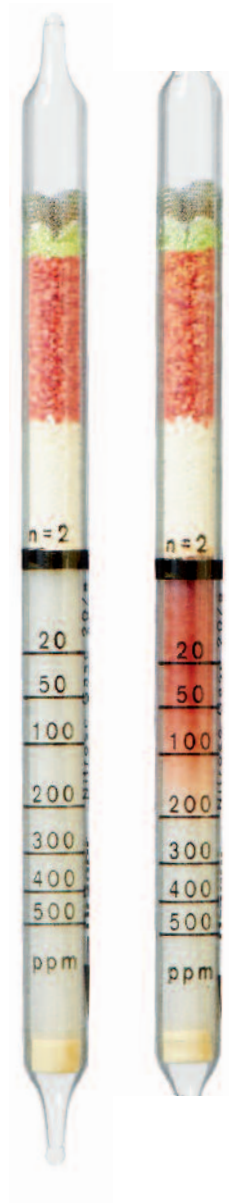

D-5-698/2014

Nitrous Fumes 50/a

Order No. 81 01 921

Application Range

Standard Measuring Range: 50 to 1,000 ppm / 250 to 2,000 ppm

Number of Strokes n: 2 / 1

Time for Measurement: 80 s / 40 s

Standard Deviation: ± 10 to 15 %

Color Change: white \rightarrow yellowish green

Ambient Operating Conditions

Temperature: 10 to 40 °C

Absolute Humidity: max. 30 mg H₂O / L

Reaction Principle

a) $\text{NO} + \text{Cr}^{\text{VI}} \rightarrow \text{NO}_2$

b) $\text{NO}_2 + \text{aromatic amine} \rightarrow \text{yellowish green reaction product}$

Cross Sensitivity

Chlorine and ozone are also indicated, but with different sensitivities.

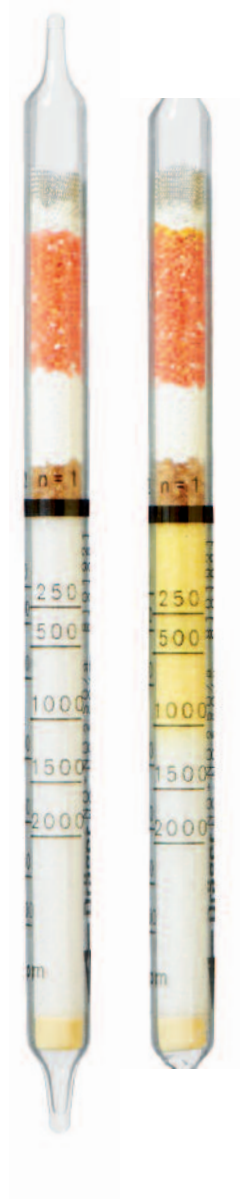

Nitrous Fumes 100/c

Order No. CH 27 701

N

Application Range

Standard Measuring Range: 100 to 1,000 ppm / 500 to 5,000 ppm

Number of Strokes n: 5 / 1 + 4
desorption strokes in clean air.

Time for Measurement: approx. 1.5 min / approx. 18 sec

Standard Deviation: ± 10 to 20 %

Color Change: grey \rightarrow red brown

Ambient Operating Conditions

Temperature: 10 to 30 °C

Absolute Humidity: max. 30 mg H₂O / L

Reaction Principle

a) $\text{NO} + \text{Cr}^{\text{VI}} \rightarrow \text{NO}_2$

b) $\text{NO}_2 + \text{o-dianisidine} \rightarrow \text{red brown reaction product}$

Cross Sensitivity

Chlorine and ozone are also indicated, but with different sensitivities.

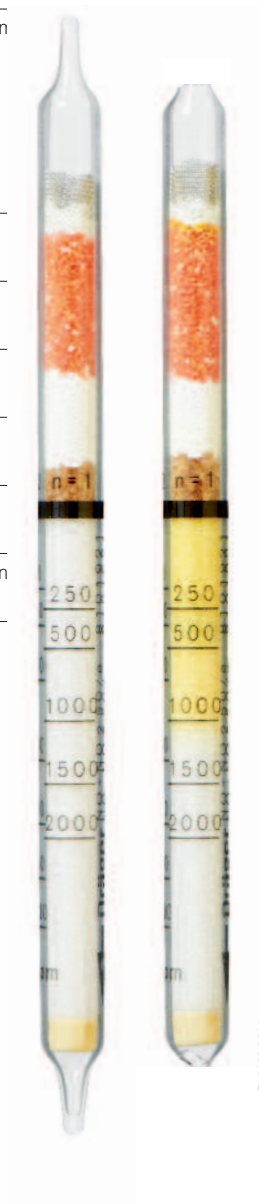

D-5462-2014

Oil Mist 1/a

Order No. 67 33 031

Application Range

Standard Measuring Range:	1 to 10 mg/m ³ Discoloration compared to color standard.
Number of Strokes n:	100
Time for Measurement:	approx. 25 min
Standard Deviation:	± 30 %
Color Change:	white → brown

Ambient Operating Conditions

Temperature:	10 to 30 °C
Absolute Humidity:	< 20 mg H ₂ O / L

Reaction Principle

Oil mist + H₂SO₄ → brown reaction product

Additional Information

After performing the required 100 pump strokes the reagent ampoule must be broken and the liquid carefully drawn onto the indication layer using the pump.



Olefine 0.05%/a

Order No. CH 31 201

N

Application Range

Standard Measuring Range:	0.06 to 3.2 vol. % propylene 0.04 to 2.4 vol. % butylene
Number of Strokes n:	20 to 1
Time for Measurement:	max. 5 min
Standard Deviation:	± 30 %
Color Change:	violet → pale brown

Ambient Operating Conditions

Temperature:	0 to 40 °C
Absolute Humidity:	< 30 mg H ₂ O / L

Reaction Principle

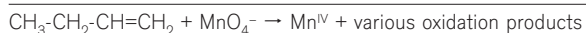

Cross Sensitivity

Many organic compounds with C=C double bonds are indicated, but with different sensitivities. It is impossible to differentiate between them. It is impossible to measure olefines in the presence of dialkyl sulfides.



ST-84-2001

Oxygen 5%/B

Order No. 67 28 081

Application Range

Standard Measuring Range:	5 to 23 vol. %
Number of Strokes n:	1
Time for Measurement:	approx. 1 min
Standard Deviation:	± 5 to 10 %
Color Change:	blue black → white

Ambient Operating Conditions

Temperature:	0 to 50 °C
Absolute Humidity:	3 to 20 mg/L

Reaction Principle

- $O_2 + TiCl_3 \rightarrow Ti^{IV}\text{-compound} + HCl$
- Adsorption of HCl by silica gel

Cross Sensitivity

Carbon dioxide, carbon monoxide, solvent vapors, halogenated hydrocarbons and N_2O do not affect the indication.

Additional Information

These tubes become very warm during measurement, reaching temperatures of approximately 100 °C. Therefore these tubes should not be used in potentially combustible atmospheres. If in doubt, test the area before using the tube with a combustible gas monitor, before using the tube.



ST-5743/2004

Oxygen 5%/C

Order No. 81 03 261



Application Range

Standard Measuring Range:	5 to 23 vol. %
Number of Strokes n:	1
Time for Measurement:	approx. 1 min
Standard Deviation:	± 10 to 15 %
Color Change:	blue black → white

Ambient Operating Conditions

Temperature:	5 to 50 °C
Absolute Humidity:	0 to 40 mg H ₂ O / L

Reaction Principle

- $O_2 + TiCl_3 \rightarrow Ti^{IV}\text{-compound} + HCl$
- Adsorption of HCl by silica gel

Cross Sensitivity

Carbon dioxide, carbon monoxide, solvent vapors, halogenated hydrocarbons and N₂O do not affect the indication.

Additional Information

These tubes become very warm during measurement, reaching temperatures of approximately 100 °C. Therefore these tubes should not be used in potentially combustible atmospheres. If in doubt, test the area before using the tube with a combustible gas monitor, before using the tube.



ST-5744-2004

Ozone 0.05/b

Order No. 67 33 181

Application Range

Standard Measuring Range:	0.05 to 0.7 ppm
Number of Strokes n:	10
Time for Measurement:	approx. 3 min
Standard Deviation:	± 10 to 15 %
Color Change:	pale blue → white

Ambient Operating Conditions

Temperature:	0 to 40 °C
Absolute Humidity:	2 to 30 mg H ₂ O / L

Reaction Principle



Cross Sensitivity

No interference by:

1 ppm sulfur dioxide

1 ppm chlorine

1 ppm nitrogen dioxide

Higher concentrations of chlorine and nitrogen dioxide discolor the indicating layer a diffuse white to pale grey.

Extension of the Measuring Range

Using $n = 5$, multiply the reading by 2; the measuring range will be 0.1 to 1.4 ppm. Using $n = 100$, divide the reading by 10; the range of measurement is 0.005 to 0.07 ppm.



Ozone 10/a

Order No. CH 21 001

Application Range

Standard Measuring Range:	20 to 300 ppm
Number of Strokes n:	1
Time for Measurement:	approx. 20 s
Standard Deviation:	± 10 to 15 %
Color Change:	greenish blue → yellow

Ambient Operating Conditions

Temperature:	0 to 40 °C
Absolute Humidity:	2 to 30 mg H ₂ O / L

Reaction Principle



Cross Sensitivity

No interference by:

1 ppm sulfur dioxide

1 ppm chlorine

1 ppm nitrogen dioxide.

Higher concentrations of chlorine and nitrogen dioxide discolor the indicating layer a diffuse yellowish grey.

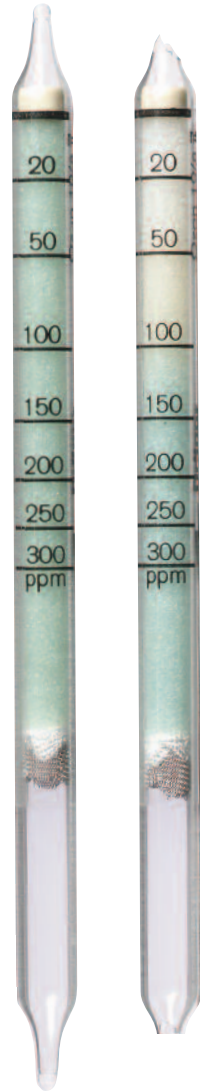

ST-198-2001

Pentane 100/a

Order No. 67 24 701

Application Range

Standard Measuring Range:	100 to 1,500 ppm
Number of Strokes n:	5
Time for Measurement:	approx. 3 min
Standard Deviation:	± 15 to 20 %
Color Change:	yellow → blue

Ambient Operating Conditions

Temperature:	15 to 40 °C
Absolute Humidity:	3 to 15 mg H ₂ O / L

Reaction Principle

$C_5H_{12} + Cr^{VI} \rightarrow Cr^{III} + \text{various oxidation products}$

Cross Sensitivity

Alcohols, esters, aromatics, petroleum hydrocarbons and ethers are indicated, but with different sensitivities. It is impossible to differentiate between them.

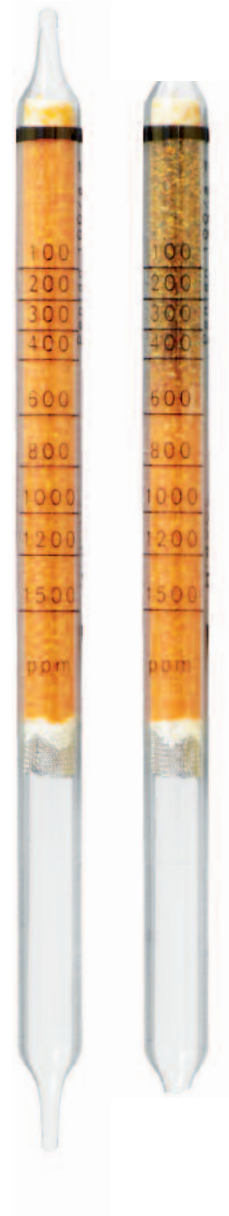

D-5-698-2014

Perchloroethylene 0.1/a

Order No. 81 01 551

Application Range

Standard Measuring Range:	0.5 to 4 ppm	/ 0.1 to 1 ppm
Number of Strokes n:	3	/ 9
Time for Measurement:	approx. 3 min	/ approx. 9 min
Standard Deviation:	± 15 to 20 %	
Color Change:	light grey → blue	

Ambient Operating Conditions

Temperature:	15 to 30 °C
Absolute Humidity:	max. 30 mg H ₂ O / L

Reaction Principle

- a) $\text{CCl}_2 = \text{CCl}_2 + \text{MnO}_4^- \rightarrow \text{Cl}_2$
 b) $\text{Cl}_2 + \text{diphenylbenzidine} \rightarrow \text{blue reaction product}$

At higher concentrations there may be created a reddish area at the beginning of the indicating layer.

Cross Sensitivity

Other chlorinated hydrocarbons, free halogens and hydrogen halides are also indicated. Petroleum hydrocarbon vapors result in a shortened reading once they exceed the following concentrations: 40 ppm with 9 strokes or 160 ppm with 3 strokes.



ST-5751-2004

Perchloroethylene 2/a

Order No. 81 01 501

Application Range

Standard Measuring Range:	20 to 300 ppm	/ 2 to 40 ppm
Number of Strokes n:	1	/ 5
Time for Measurement:	approx. 30 s	/ approx. 3 min
Standard Deviation:	± 15 to 20 %	
Color Change:	yellow → grey blue	

Ambient Operating Conditions

Temperature:	15 to 30 °C
Absolute Humidity:	< 25 mg H ₂ O / L

Reaction Principle

- $\text{CCl}_2=\text{CCl}_2 + \text{MnO}_4^- \rightarrow \text{Cl}_2$
- $\text{Cl}_2 + \text{diphenylbenzidine} \rightarrow \text{grey blue reaction product}$

At higher concentrations there may be created a reddish area at the beginning of the indicating layer.

Cross Sensitivity

Other chlorinated hydrocarbons, free halogens and hydrogen halides are also indicated. Petroleum hydrocarbon vapors result in a shortened reading once they exceed the following concentrations: 50 ppm with 5 strokes or 500 ppm with 1 stroke.



ST-90-2001

Perchloroethylene 10/b

Order No. CH 30 701

P

Application Range

Standard Measuring Range:	10 to 500 ppm
Number of Strokes n:	3
Time for Measurement:	approx. 40 s
Standard Deviation:	± 15 to 20 %
Color Change:	grey → orange

Ambient Operating Conditions

Temperature:	15 to 40 °C
Absolute Humidity:	5 to 12 mg H ₂ O / L

Reaction Principle

- $\text{CCl}_2=\text{CCl}_2 + \text{MnO}_4^- \rightarrow \text{Cl}_2$
- $\text{Cl}_2 + \text{o-Tolidine} \rightarrow \text{orange reaction product}$

Cross Sensitivity

Other chlorinated hydrocarbons, free halogens and hydrogen halides are also indicated. Petroleum hydrocarbon vapors result in a shortened reading.



ST-69/2001

Petroleum Hydrocarbons 10/a

Order No. 81 01 691

Application Range

Standard Measuring Range:	10 to 300 ppm for n-octane.
Number of Strokes n:	2
Time for Measurement:	approx. 1 min
Standard Deviation:	± 25 %
Color Change:	white → brownish green

Ambient Operating Conditions

Temperature:	15 to 30 °C
Absolute Humidity:	1 to 20 mg H ₂ O / L

Reaction Principle

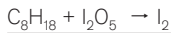

Cross Sensitivity

In addition to n-octane other organic or inorganic compounds are indicated as well.

50 ppm n-hexane indicates a discoloration of approx.	70 ppm
100 ppm n-heptane indicates a discoloration of approx.	150 ppm
10 ppm iso-octane indicates a discoloration of approx.	15 ppm
100 ppm iso-octane indicates a discoloration of approx.	150 ppm
200 ppm iso-octane indicates a discoloration of approx.	350 ppm
50 ppm n-nonane indicates a discoloration of approx.	50 ppm
50 ppm perchloroethylene indicates a discoloration of approx.	50 ppm
30 ppm CO indicates a discoloration of approx.	20 ppm

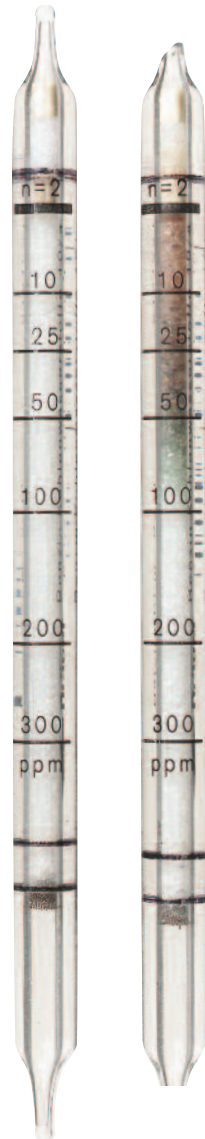

ST-19-2001

Petroleum Hydrocarbons 100/a

Order No. 67 30 201

P

Application Range

Standard Measuring Range:	100 to 2,500 ppm for n-octane.
Number of Strokes n:	2
Time for Measurement:	approx. 30 s
Standard Deviation:	± 10 to 15 %
Color Change:	white → green

Ambient Operating Conditions

Temperature:	0 to 40 °C
Absolute Humidity:	< 30 mg H ₂ O / L

Reaction Principle

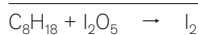

Cross Sensitivity

Many other petroleum hydrocarbons are indicated as well, but with different sensitivities. It is impossible to differentiate between them. Aromatics are indicated, but only with low sensitivities. Carbon monoxide is indicated in comparable concentrations with about half the sensitivity.

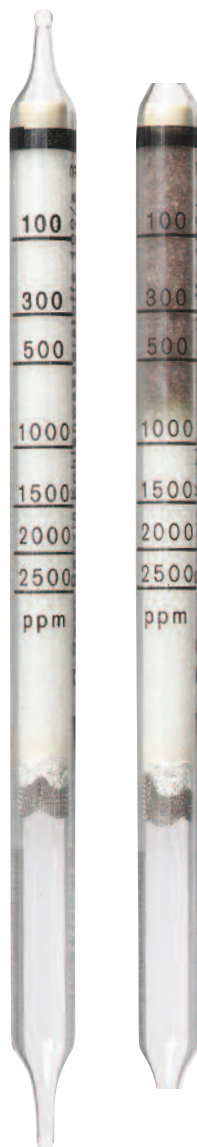

SI-30-2001

Phenol 1/b

Order No. 81 01 641

Application Range

Standard Measuring Range:	1 to 20 ppm
Number of Strokes n:	20
Time for Measurement:	approx. 5 min
Standard Deviation:	± 10 to 15 %
Color Change:	yellow → brown grey

Ambient Operating Conditions

Temperature:	10 to 30 °C
Absolute Humidity:	1 to 18 mg H ₂ O / L

Reaction Principle

$C_6H_5OH + Ce(SO_4)_2 + H_2SO_4 \rightarrow$ brown grey reaction product

Cross Sensitivity

Cresols are also indicated, but with different sensitivities. To determine m-cresol multiply the indication by 0.8. Benzene, toluene and other aromatics without the heteroatoms are not indicated. Aliphatic hydrocarbons and alcohols are not indicated.

Additional Information

At a temperature of 0 °C the resulting indication must be multiplied by 1.3, at a temperature of 40 °C it must be multiplied by 0.8.

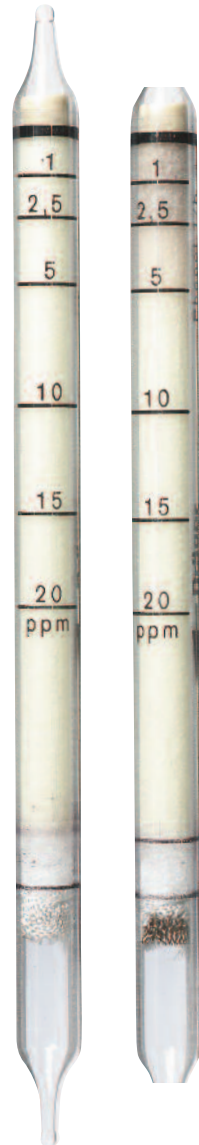

Phosgene 0.02/a

Order No. 81 01 521

P

Application Range

Standard Measuring Range:	0.02 to 1 ppm	/	0.02 to 0.6 ppm
Number of Strokes n:	20	/	40
Time for Measurement:	approx. 6 min	/	approx. 12 min
Standard Deviation:	± 10 to 15 %		
Color Change:	white → red		

Ambient Operating Conditions

Temperature:	0 to 40 °C
Absolute Humidity:	3 to 15 mg H ₂ O / L

Reaction Principle

$\text{COCl}_2 + \text{aromatic amine} \rightarrow \text{red reaction product}$

Cross Sensitivity

Chlorine and hydrochloric acid lead to plus errors and, at higher concentrations, to bleaching of the indicating layer. Concentrations of phosgene above 30 ppm will also lead to bleaching of the indicating layer.

Additional Information

High concentrations of phosgene will be not indicated!

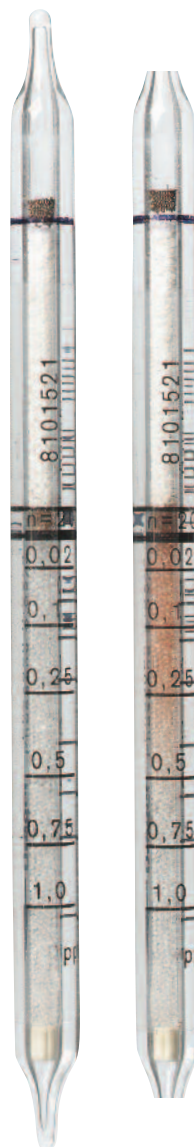

ST-98-2001

Phosgene 0.05/a

Order No. CH 19 401

Application Range

Standard Measuring Range:	0.04 to 1.5 ppm
Number of Strokes n:	33 to 1
Time for Measurement:	max. 11 min
Standard Deviation:	± 20 to 30 %
Color Change:	yellow → bluish-green

Ambient Operating Conditions

Temperature:	10 to 30 °C
Absolute Humidity:	< 20 mg H ₂ O / L

Reaction Principle

COCl₂ + ethylaniline +
dimethylaminobenzaldehyde → blue green reaction product

Cross Sensitivity

Carbonyl bromide and acetyl chloride are indicated.



Phosgene 0.25/c

Order No. CH 28 301

P

Application Range

Standard Measuring Range:	0.25 to 5 ppm
Number of Strokes n:	5
Time for Measurement:	approx. 1 min
Standard Deviation:	± 15 to 20 %
Color Change:	yellow → blue green

Ambient Operating Conditions

Temperature:	5 to 35 °C
Absolute Humidity:	3 to 15 mg H ₂ O / L

Reaction Principle

COCl₂ + ethylaniline +
dimethylaminobenzaldehyde → blue green reaction product

Cross Sensitivity

No interference by up to 100 ppm hydrochloric acid. Carbonyl bromide and acetyl chloride are indicated, but with different sensitivities. It is impossible to measure phosgene in the presence of carbonyl bromide or acetyl chloride.

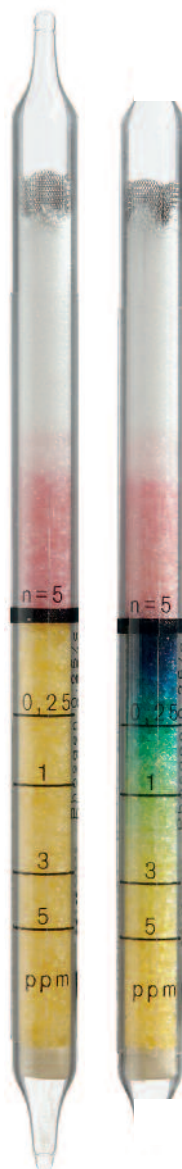

D-135-48-2010

Phosphine 0.01/a

Order No. 81 01 611

Application Range

Standard Measuring Range:	0.1 to 1.0 ppm	/ 0.01 to 0.3 ppm
Number of Strokes n:	3	/ 10
Time for Measurement:	approx. 2.5 min	/ approx. 8 min
Standard Deviation:	± 10 to 15 %	
Color Change:	yellow → red	

Ambient Operating Conditions

Temperature:	2 to 40 °C
Absolute Humidity:	< 20 mg H ₂ O / L

Reaction Principle

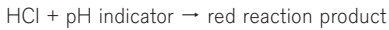

Cross Sensitivity

Arsine is indicated with different sensitivity. Up to 6 ppm sulfur dioxide or 15 ppm hydrochloric acid does not interfere, but higher concentrations cause plus errors. More than 100 ppm ammonia leads to minus errors. 30 ppm hydrocyanic acid does not affect the 3 stroke test, but with the 10 stroke test minus errors of up to 50 % can occur.

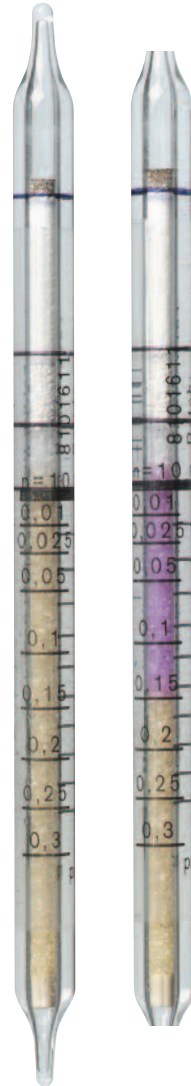

ST-110-2001

Phosphine 0.1/c

Order No. 81 03 711

P

Application Range

Standard Measuring Range:	0.5 to 3 ppm / 0.1 to 1.0 ppm
Number of Strokes n:	1 / 3
Time for Measurement:	approx. 1 min / approx. 2.5 min
Standard Deviation:	± 10 to 15 %
Color Change:	yellow → red

Ambient Operating Conditions

Temperature:	2 to 40 °C
Absolute Humidity:	< 40 mg H ₂ O / L

Reaction Principle

$\text{HgCl}_2 + \text{PH}_3 \rightarrow \text{Hg-phosphide} + \text{HCl}$

$\text{HCl} + \text{pH-Indicator} \rightarrow \text{red reaction product}$

Cross Sensitivity

A maximum of 6 ppm sulphur dioxide or 15 ppm hydrogen chloride have no influence on the reasing. Higher concentration result in plus errors. Ammonia (>100 ppm) result in minus errors. Hydrogen sulphide and Arsine are indicated with different sensitivity. 30 ppm hydrocyanic acid does not affect.

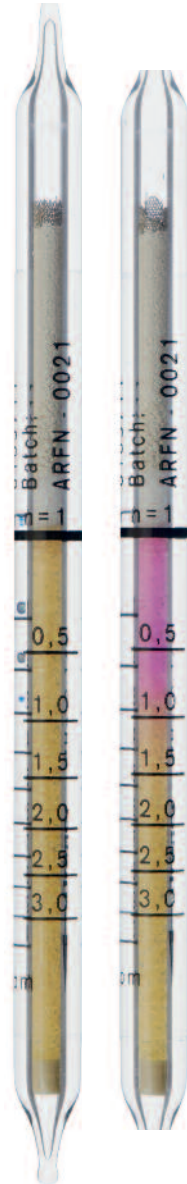

D-21246-2015

Phosphine 0.1/b in Acetylene

Order No. 81 03 341

Application Range

Standard Measuring Range:	0.1 to 1 ppm	/ 1 to 15 ppm
Number of Strokes n:	10	/ 1
Time for Measurement:	approx. 4 min	/ approx. 20 s
Standard Deviation:	± 15 to 20 %	
Color Change:	yellow orange → red violet	

Ambient Operating Conditions

Temperature:	2 to 40 °C
Absolute Humidity:	< 20 mg / L

Reaction Principle

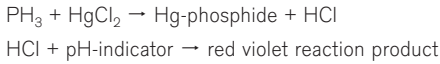

Cross Sensitivity

Arsin and hydrogen sulfide will be indicated with differing sensitivities.

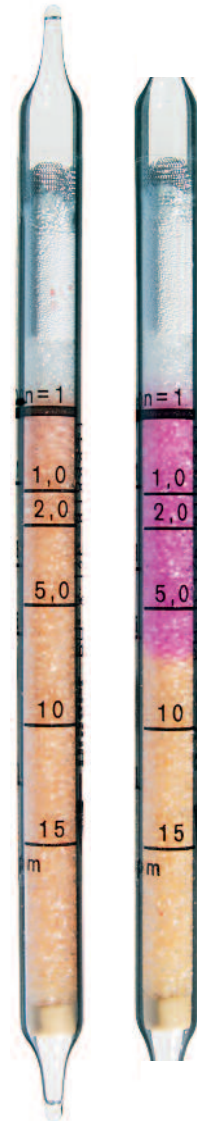

ST-5759-2004

Application Range

Standard Measuring Range:	20 to 100	/ 1 to 20 ppm
Number of Strokes n:	2	/ 10
Time for Measurement:	approx. 2 min	/ approx. 10 min
Standard Deviation:	± 15 to 20 %	
Color Change:	yellow → dark-brown	

Ambient Operating Conditions

Temperature:	5 to 40 °C
Absolute Humidity:	max. 30 mg H ₂ O / L

Reaction Principle

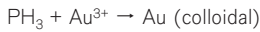

Cross Sensitivity

Ammonia, hydrogen chloride, hydrogen sulfide and mercaptans are retained in the prelayer. Arsine and stibine are also indicated, however, with less sensitivity.

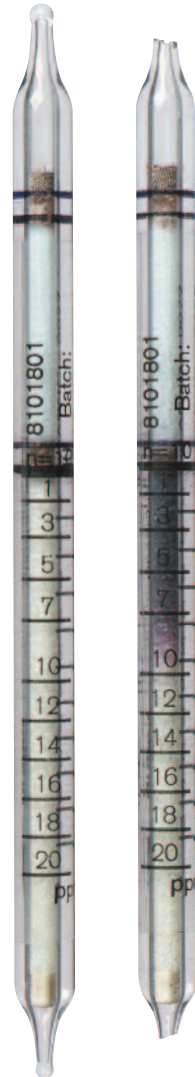

Phosphine 25/A

Order No. 81 01 621

Application Range

Standard Measuring Range:	200 to 10,000 ppm / 25 to 900 ppm	
Number of Strokes n:	1	/ 10
Time for Measurement:	approx. 1.5 min	/ approx. 10 min
Standard Deviation:	± 10 to 15 %	
Color Change:	yellow → dark brown	

Ambient Operating Conditions

Temperature:	0 to 40 °C
Absolute Humidity:	< 30 mg H ₂ O / L

Reaction Principle

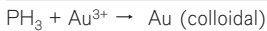

Cross Sensitivity

Arsine and antimony hydride are indicated, but with lower sensitivities.

Hydrogen sulfide, ammonia, hydrochloric acid and mercaptans are retained in the pre-cleanse layer.



ST 200-2001

Phosphine 50/a

Order No. CH 21 201

P

Application Range

Standard Measuring Range:	50 to 1,000 ppm
Number of Strokes n:	3
Time for Measurement:	approx. 2 min
Standard Deviation:	± 10 to 15 %
Color Change:	yellow → brown black

Ambient Operating Conditions

Temperature:	0 to 50 °C
Absolute Humidity:	< 40 mg H ₂ O / L

Reaction Principle

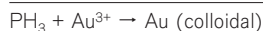

Cross Sensitivity

Arsine and antimony hydride are indicated, but with different sensitivities.

Hydrogen sulfide, mercaptans, ammonia, carbon monoxide, sulfur dioxide and hydrochloric acid in the TLV range do not interfere.

Extension of the Measuring Range

Using n = 10, multiply the reading by 0.3; the range of measurement is 15 to 300 ppm.



ST-113-2001

Application Range

Standard Measuring Range:	Qualitative determination of easily oxidable substances
Number of Strokes n:	5
Time for Measurement:	approx. 1.5 min
Color Change:	white → brown, green or violet (depending on substance)

Ambient Operating Conditions

Temperature:	0 to 50 °C
Absolute Humidity:	max. 50 mg H ₂ O / L

Reaction Principle

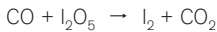

Cross Sensitivity

Based on the reaction principle, many easily oxidised compounds are indicated, several examples are shown below:

2000 ppm acetone	10 ppm acetylene
50 ppm ethylene	1 ppm arsine
10 ppm octane	50 ppm benzene
500 ppm propane	100 ppm butane
5 ppm carbon monoxide	10 ppm styrene
1 ppm carbon disulfide	20 ppm perchloroethylene
2 ppm hydrogen sulfide	10 ppm toluene, Xylene

Methane, ethane, hydrogen and carbon dioxide are not indicated.

Additional Information

If there is no reading, this does not always indicate that easily oxidizable substances are not present. In the individual case, the use of Dräger Polytest should be qualified by independent methods, particularly when combustible gases and vapors close to the LEL, or toxic substances are suspected.



Pyridine 5/A

Order No. 67 28 651

P

Application Range

Standard Measuring Range:	5 ppm
Number of Strokes n:	20 additional 5 strokes have to be taken in clean air after opening the second reagent ampoule.
Time for Measurement:	approx. 20 min
Standard Deviation:	± 30 %
Color Change:	white → brown red

Ambient Operating Conditions

Temperature:	10 to 30 °C
Absolute Humidity:	3 to 15 mg H ₂ O / L

Reaction Principle

Pyridine + Aconitic acid + Acetic anhydride → brown red reaction product

Cross Sensitivity

Ammonia in the TLV range does not interfere.

Additional Information

Before carrying out the measurement the lower reagent ampoule must be broken and the liquid transferred to the indication layer so that it is saturated. After performing 20 pump strokes, the upper reagent ampoule must be broken. The granular contents must be shaken out of the broken ampoule by gently tapping the side of the tube. The tube must be held vertically with the inlet of the tube up during the 5 additional pump strokes.



ST-203-2001

Styrene 10/a

Order No. 67 23 301

Application Range

Standard Measuring Range:	10 to 200 ppm
Number of Strokes n:	max. 15
Time for Measurement:	max. 3 min
Standard Deviation:	± 15 to 20 %
Color Change:	white → pale yellow

Ambient Operating Conditions

Temperature:	15 to 40 °C
Absolute Humidity:	< 15 mg H ₂ O / L

Reaction Principle

$C_6H_5-CH=CH_2 + H_2SO_4 \rightarrow$ pale yellow reaction product

Cross Sensitivity

Other organic compounds which tend toward polymerization (e. g. butadiene) are indicated, but with different sensitivities. It is impossible to measure monostyrene in the presence of these compounds.



ST-5746-2004

Styrene 10/b

Order No. 67 33 141

P

Application Range

Standard Measuring Range:	10 to 250 ppm
Number of Strokes n:	20
Time for Measurement:	approx. 3 min
Standard Deviation:	± 15 to 20 %
Color Change:	white → red brown

Ambient Operating Conditions

Temperature:	0 to 40 °C
Absolute Humidity:	3 to 15 mg H ₂ O / L

Reaction Principle

Styrene + HCHO → red brown reaction product

Cross Sensitivity

Other organic compounds, which react with the formaldehyde/sulfuric acid indicating system (e. g. xylene, toluene, butadiene and ethyl benzene) affect the indication. It is impossible to measure monostyrene in the presence of these compounds.

No interference by:

200 ppm methanol

500 ppm octane

400 ppm ethyl acetate

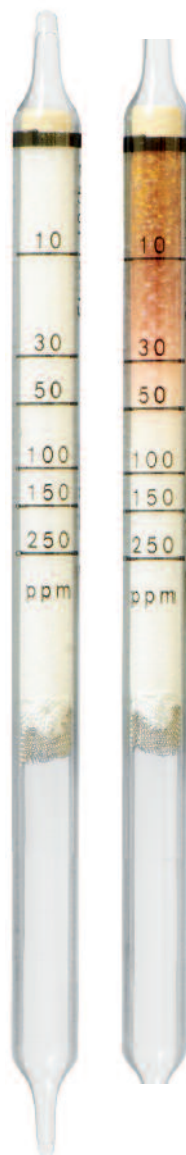

D-54432014

Styrene 50/a

Order No. CH 27 601

Application Range

Standard Measuring Range:	50 to 400 ppm
Number of Strokes n:	2 to 11
Time for Measurement:	max. 2 min
Standard Deviation:	± 30 %
Color Change:	white → yellow

Ambient Operating Conditions

Temperature:	10 to 40 °C
Absolute Humidity:	< 15 mg H ₂ O / L

Reaction Principle

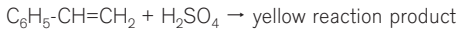

Cross Sensitivity

Other organic compounds which tend toward polymerization (e. g. butadiene) are indicated. It is impossible to measure monostyrene in the presence of these compounds.

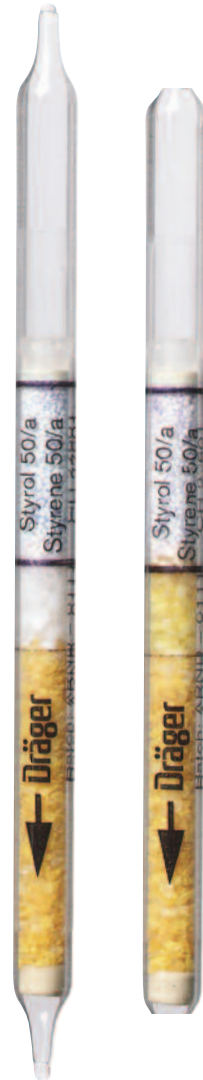

Sulfuryl Fluoride 1/a

Order No. 81 03 471

S

Application

Standard Measuring Range:	1 to 5 ppm
Number of Strokes n:	6
Time for Measurement:	approx. 3 min
Standard Deviation:	± 30 %
Color Change:	light blue → light pink

Ambient Operating Conditions

Temperature:	0 to 40 °C
Absolute Humidity:	15 to 90 % r.h.

At 0 to 10 °C, concentrations of sulfuryl fluoride are displayed with approximately half sensitivity.

At 30 to 40 °C and air humidity < 30 % r.h. the displays can only be recognised as of > 2 ppm.

At 30 to 40 °C and air humidity > 75 % r. h., concentrations of sulfuryl fluoride are displayed with approximately half sensitivity.

Reaction Principle

- pyrolysis sulfuryl fluoride → HF
- HF + zircon / quinalizarin → pink reaction product (HF destroys the quinalizarin/zircon complex by complexation of the zircon)

Cross Sensitivity

Fluorinated hydrocarbons are also displayed with different sensitivities. Ammonia and other basic gases could, depending on the concentrations, either shorten or prevent the color change. The following chemicals have no influence on the display of 3 ppm sulfuryl fluoride: 2 ppm formaldehyde, 5 ppm methyl bromide and 1 ppm phosphine.

When the oxygen concentration decreases, the sensitivity decreases. For example, the 3 ppm display at 18 % oxygen is very weak.

Additional Information

Do not use in areas subject to explosion hazards. Tubes get hot. During and shortly after measurement, do not touch the first tube near the black pyrolysis layer.



ST-418-2008

Sulfur Dioxide 0.1/a

Order No. 67 27 101

Application Range

Standard Measuring Range:	0.1 to 3 ppm
Number of Strokes n:	100
Time for Measurement:	approx. 20 min
Standard Deviation:	± 10 to 15 %
Color Change:	yellow → orange

Ambient Operating Conditions

Temperature:	10 to 30 °C
Absolute Humidity:	3 to 15 mg H ₂ O / L

Reaction Principle



Cross Sensitivity

It is impossible to measure sulfur dioxide in the presence of other acidic gases.

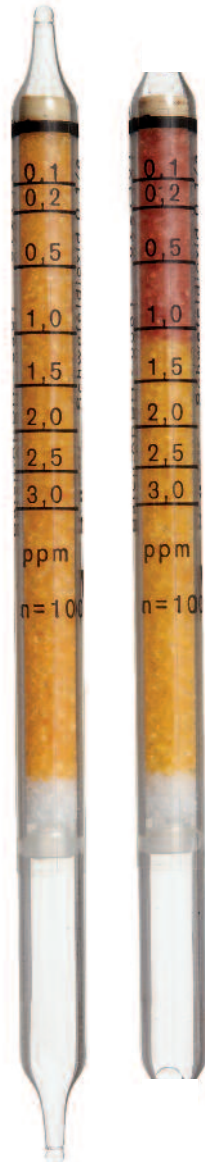

Sulfur Dioxide 0.5/a

Order No. 67 28 491

S

Application Range

Standard Measuring Range:	1 to 25 ppm	/ 0.5 to 5 ppm
Number of Strokes n:	10	/ 20
Time for Measurement:	approx. 3 min	/ approx. 6 min
Standard Deviation:	± 10 to 15 %	
Color Change:	grey blue → white	

Ambient Operating Conditions

Temperature:	15 to 30 °C
Absolute Humidity:	max. 20 mg H ₂ O / L

Reaction Principle

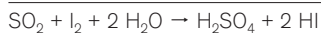

Cross Sensitivity

Measurement is not possible in the presence of H₂S. Nitrogen dioxide will shorten the reading.



ST-121-2001

Sulfur Dioxide 1/a

Order No. CH 31 701

Application Range

Standard Measuring Range:	1 to 25 ppm
Number of Strokes n:	10
Time for Measurement:	approx. 3 min
Standard Deviation:	± 10 to 15 %
Color Change:	grey blue → white

Ambient Operating Conditions

Temperature:	15 to 25 °C
Absolute Humidity:	3 to 20 mg H ₂ O / L

Reaction Principle

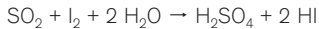

Cross Sensitivity

Hydrogen sulfide in the TLV range is retained in the pre-layer and does not interfere. Nitrogen dioxide will shorten the reading.

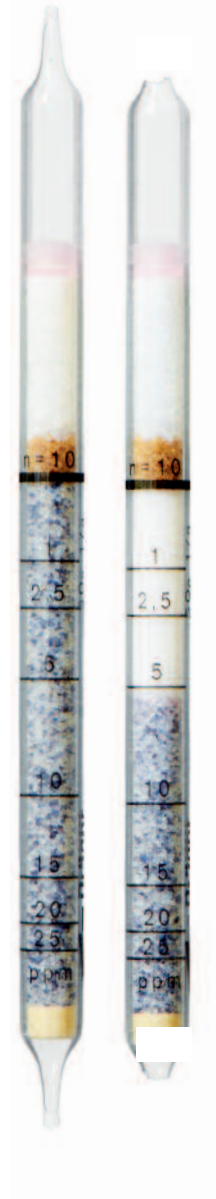

D-544632014

Sulfur Dioxide 20/a

Order No. CH 24 201

S

Application Range

Standard Measuring Range:	20 to 200 ppm
Number of Strokes n:	10
Time for Measurement:	approx. 3 min
Standard Deviation:	± 10 to 15 %
Color Change:	brown yellow → white

Ambient Operating Conditions

Temperature:	0 to 40 °C
Absolute Humidity:	< 30 mg H ₂ O / L

Reaction Principle

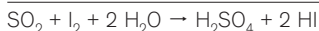

Cross Sensitivity

Hydrogen sulfide is indicated, with the same sensitivity. It is impossible to measure sulfur dioxide in the presence of hydrogen sulfide. Nitrogen dioxide will shorten the reading.

Extension of the Measuring Range

Using n = 1+3 desorption strokes, multiply the reading by 10; the range of measurement is 200 - 2,000 ppm. The desorption strokes are to be taken in clean air (i.e. free of sulfur dioxide) immediately following the single pump stroke.

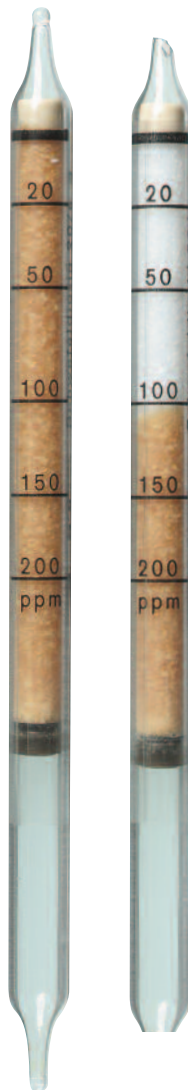

ST-123-2001

Sulfur Dioxide 50/b

Order No. 81 01 531

Application Range

Standard Measuring Range:	400 to 8,000 / 50 to 500 ppm
Number of Strokes n:	1 / 10
Time for Measurement:	approx. 15 s / approx. 3 min
Standard Deviation:	± 10 to 15 %
Color Change:	blue → yellow

Ambient Operating Conditions

Temperature:	0 to 50 °C
Absolute Humidity:	1 to 15 mg H ₂ O / L

Reaction Principle

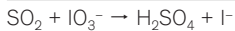

Cross Sensitivity

Hydrochloric acid is indicated in high concentrations. 10,000 ppm Hydrochloric acid corresponds to an indication of 150 ppm sulfur dioxide.

No interference by:

500 ppm nitrogen monoxide

100 ppm nitrogen dioxide



Sulfuric Acid 1/a

Order No. 67 28 781

S

Application Range

Standard Measuring Range:	1 to 5 mg/m ³ Discoloration compared to color comparison tube.
Number of Strokes n:	100
Time for Measurement:	approx. 100 min
Standard Deviation:	± 30 %
Color Change:	brown → pink violet

Ambient Operating Conditions

Temperature:	5 to 40 °C
Absolute Humidity:	< 15 mg H ₂ O / L

Reaction Principle

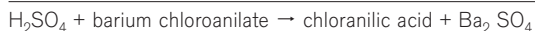

Cross Sensitivity

Sulfur trioxide in the gaseous form is not indicated, but in the presence of atmospheric humidity this forms sulfuric acid aerosols, which are indicated.

Soluble sulfates and other aerosol forming acids are also indicated but with different sensitivities. It is impossible to measure sulfuric acid in the presence of these substances.

Additional Information

After performing the required 100 pump strokes the reagent ampoule must be broken and the liquid transferred completely onto the brown reagent layer. Wait one minute before drawing the liquid carefully through the brown layer with approx. $\frac{1}{4}$ pump stroke into the indication chamber. The measurement must be evaluated immediately.



D-5/41:2014

Tertiary Butylmercaptan Natural Gas Odorization

Order No. 81 03 071

Application Range

Standard Measuring Range:	3 to 15 mg/m ³	/	1 to 10 mg/m ³
Number of Strokes n:	3	/	5
Time for Measurement:	3 min	/	5 min
Standard Deviation:	± 15 to 20 %		
Color Change:	yellow → pink		

Ambient Operating Conditions

Temperature:	20 to 35 °C
Absolute Humidity:	< 15 mg H ₂ O / L

Reaction Principle

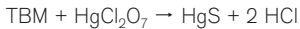

HCl + pH-indicator → pink reaction product

Cross Sensitivity

Hydrogen sulfide, sulfur dioxide, mercaptane, arsine, nitrogen dioxide and phosphine are indicated as well, but with different sensitivities.

Additional Information

For applications in an environment with temperatures below 20 °C use temperature correction. To do so refer to the instructions for use.

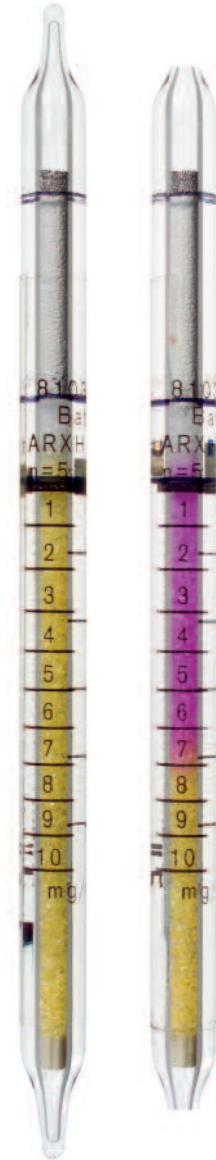

ST-380-2008

Tetrahydrothiophene 1/b

Order No. 81 01 341

S

Application Range

Standard Measuring Range:	1 to 10 ppm / 4 to 40 mg/m ³
Number of Strokes n:	30
Time for Measurement:	in air: approx. 15 min in natural gas: approx. 10 min
Standard Deviation:	± 15 to 20 %
Color Change:	violet → yellow brown

Ambient Operating Conditions

Temperature:	0 to 35 °C
Absolute Humidity:	< 30 mg H ₂ O / L

Reaction Principle

THT + KMnO₄ → yellow brown reaction product

Cross Sensitivity

Up to 10 ppm hydrogen sulfide is adsorbed in the pretube, causing a brown discoloration. It is impossible to measure tetrahydrothiophene in the presence of mercaptans. Up to 100 ppm of olefins (e. g. ethene, propene) will cause the color of the indicating layer to become lighter, at higher concentrations the olefins are also indicated. Up to 200 ppm methanol does not interfere.

Extension of Measuring Range

1.6 to 16 ppm / 6.4 to 64 mg/m³
n = 20 multiply the reading by 1.6



ST-206-2001

Thioether

Order No. CH 25 803

Application Range

Standard Measuring Range:	1 mg/m ³ is the minimum detectable concentration in form of a ring.
Number of Strokes n:	8
Time for Measurement:	approx. 1.5 min
Standard Deviation:	± 50 %
Color Change:	yellow → orange

Ambient Operating Conditions

Temperature:	0 to 40 °C
Absolute Humidity:	< 50 mg H ₂ O / L

Reaction Principle

R'-S-R + AuCl₃ + Chloramide → orange reaction product

Cross Sensitivity

Various thioethers are indicated, but it is impossible to differentiate between them.

Additional Information

After performing the required eight pump strokes the reagent ampoule must be broken and the liquid transferred completely onto the indication layer.



ST-149-2001

Toluene 5/b

Order No. 81 01 661

T

Application Range

Standard Measuring Range:	50 to 300 ppm / 5 to 80 ppm
Number of Strokes n:	2 / 10
Time for Measurement:	approx. 2 min / approx. 10 min
Standard Deviation:	± 10 to 15 %
Color Change:	white → pale brown

Ambient Operating Conditions

Temperature:	2 to 40 °C
Absolute Humidity:	max. 20 mg H ₂ O / L

Reaction Principle

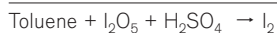

Cross Sensitivity

10 ppm phenol, 1,000 ppm acetone, 1,000 ppm ethanol and 300 ppm octane are not indicated, xylene (all isomers) and benzene are indicated with the same sensitivity. The discoloration in the presence of p-xylene is violet, and yellowish-green with benzene.

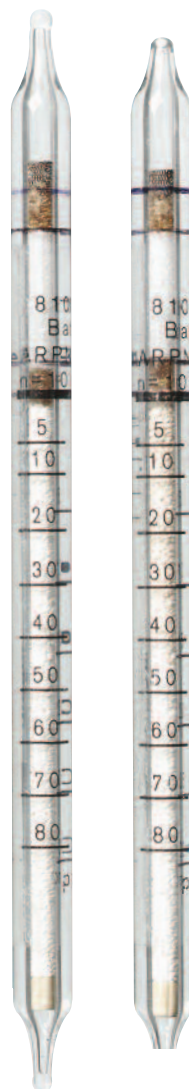

ST-161-2001

Toluene 50/a

Order No. 81 01 701

Application Range

Standard Measuring Range:	50 to 400 ppm
Number of Strokes n:	5
Time for Measurement:	approx. 1,5 min
Standard Deviation:	± 10 to 15 %
Color Change:	white → brown

Ambient Operating Conditions

Temperature:	0 to 30 °C
Absolute Humidity:	5 to 12 mg H ₂ O / L

Reaction Principle

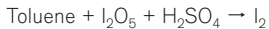

Cross Sensitivity

Xylenes will be indicated with different sensitivities. Benzene causes a total discoloration into yellow. Petroleum hydrocarbons cause a total discoloration into a diffuse red brown. Methanol, ethanol, acetone and ethyl acetate do not disturb the discoloration in the range of TLV-values.



ST-152-2001

Toluene 100/a

Order No. 81 01 731

T

Application Range

Standard Measuring Range:	100 to 1,800 ppm
Number of Strokes n:	10
Time for Measurement:	approx. 1.5 min
Standard Deviation:	± 10 to 15 %
Color Change:	white → brown violet

Ambient Operating Conditions

Temperature:	0 to 40 °C
Absolute Humidity:	< 30 mg H ₂ O / L

Reaction Principle

Toluene + SeO₂ + H₂SO₄ → brown violet reaction product

Cross Sensitivity

Xylenes are indicated with approximately the same sensitivity, but with a bluish violet color.

Benzene discolors the entire indicating layer a diffuse yellow brown.

Petroleum hydrocarbons discolor the entire indicating layer a diffuse reddish brown.

Methanol, ethanol, acetone and ethyl acetate do not interfere in the range of their TLVs.

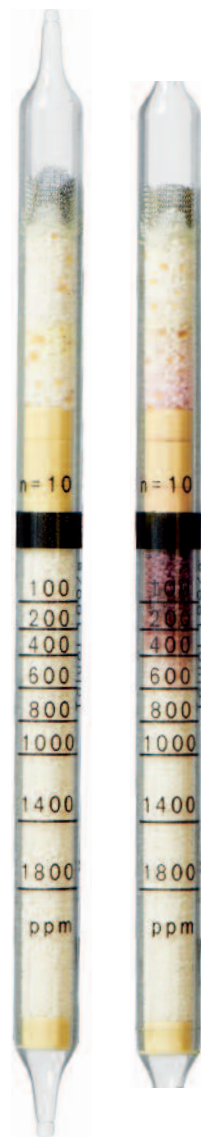

D-54450-2014

Toluene Diisocyanate 0.02/A

Order No. 67 24 501

Application Range

Standard Measuring Range:	0.02 to 0.2 ppm Discoloration compared to color comparison tube.
Number of Strokes n:	25
Time for Measurement:	approx. 20 min
Standard Deviation:	± 30 %
Color Change:	white → orange

Ambient Operating Conditions

Temperature:	15 to 30 °C
Absolute Humidity:	< 20 mg H ₂ O / L

Reaction Principle

- Pyridylpyridinium chloride + NaOH → Glutaconaldehyde sodium oletate
- 2,4-TDI (also for 2,6-TDI) + HCl → Aromatic amine
- Aromatic amine + glutaconaldehyde → orange reaction product

Cross Sensitivity

Other isocyanates are not indicated.

No interference by:

- 5 ppm aniline
- 10 ppm benzylamine
- 5 ppm toluene
- 20 ppm benzene

Mercaptans also discolor the indicating layer.

Additional Information

Before carrying out the measurement the lower reagent ampoule must be broken and the liquid transferred to the indication layer, so that it changes color to yellow. Next, the upper reagent ampoule must be broken and the liquid transferred to the indication layer, so that it returns to a white color. After performing 25 pump strokes wait 15 minutes before evaluating the indication.



Trichloroethane 50/d

Order No. CH 21 101

T

Application Range

Standard Measuring Range:	50 to 600 ppm
Number of Strokes n:	2 + 3 desorption strokes in clean air
Time for Measurement:	approx. 1.5 min
Standard Deviation:	± 10 to 15 %
Color Change:	grey → brown red

Ambient Operating Conditions

Temperature:	15 to 40 °C
Absolute Humidity:	5 to 15 mg H ₂ O / L

Reaction Principle

- 1,1,1-trichloroethane + IO₃⁻/H₂S₂O₇ → Cl₂
- Cl₂+ o-tolidine → brown red reaction product

Cross Sensitivity

Other chlorinated hydrocarbons are indicated, but with different sensitivities.

In the presence of aromatic hydrocarbons the indication is too low (e.g. 200 ppm 1,1,1-trichloroethane and 200 ppm toluene, the reading amounts to 1/4 only, i.e. 50 ppm).



D-19345-2010

Trichloroethylene 2/a

Order No. 67 28 541

Application Range

Standard Measuring Range:	20 to 250 ppm / 2 to 50 ppm
Number of Strokes n:	3 / 5
Time for Measurement:	approx. 1.5 min / 2.5 min
Standard Deviation:	± 10 to 15 %
Color Change:	pale grey → orange

Ambient Operating Conditions

Temperature:	10 to 40 °C
Absolute Humidity:	5 to 15 mg H ₂ O / L

Reaction Principle

Cl₂ + o-tolidine → orange reaction product

Cross Sensitivity

Other chlorinated hydrocarbons are indicated, but with different sensitivities.

Free halogens and hydrogen halides in the TLV range are also indicated. It is impossible to measure trichloroethylene in the presence of these substances. Petroleum hydrocarbons cause low readings.



ST-157-2001

Trichloroethylene 50/a

Order No. 81 01 881

T

Application Range

Standard Measuring Range:	50 to 500 ppm
Number of Strokes n:	5
Time for Measurement:	approx. 1.5 min
Standard Deviation:	± 10 to 15 %
Color Change:	pale grey → orange

Ambient Operating Conditions

Temperature:	15 to 40 °C
Absolute Humidity:	5 to 12 mg H ₂ O / L

Reaction Principle

- Trichloroethylene + Cr^{VI} → Cl₂
- Cl₂ + o-tolidine → orange reaction product

Cross Sensitivity

Other chlorinated hydrocarbons are indicated, but with different sensitivities.

Free halogens and hydrogen halides in the TLV range are also indicated. It is impossible to measure trichloroethylene in the presence of these substances. Petroleum hydrocarbons cause low readings.

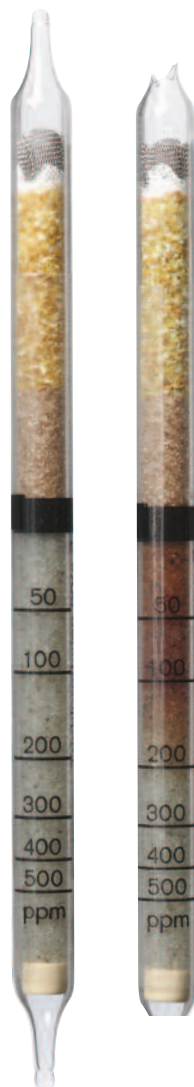

ST-154-2001

Triethylamine 5/a

Order No. 67 18 401

Application Range

Standard Measuring Range:	5 to 60 ppm
Number of Strokes n:	5
Time for Measurement:	approx. 3 min
Standard Deviation:	± 10 to 15 %
Color Change:	yellow → blue

Ambient Operating Conditions

Temperature:	10 to 40 °C
Absolute Humidity:	5 to 12 mg H ₂ O / L

Reaction Principle

$(C_2H_5)_3N + \text{acid} \rightarrow \text{blue reaction product}$

Cross Sensitivity

Other basic substances such as organic amines and ammonia are indicated, but with different sensitivities.

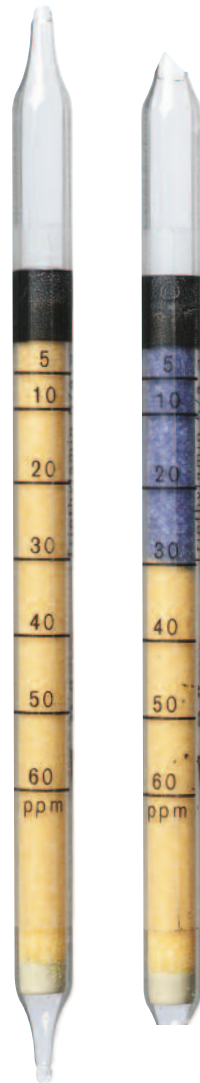

ST-163-2001

Vinyl Chloride 0.5/b

Order No. 81 01 721

T

Application Range

Standard Measuring Range:	5 to 30 ppm	/ 0.5 to 5 ppm
Number of Strokes n:	1	/ 5
Time for Measurement:	approx. 30 s	/ approx. 2.5 min
Standard Deviation:	± 15 to 20 %	
Color Change:	white → violet	

Ambient Operating Conditions

Temperature:	10 to 30 °C
Absolute Humidity:	max. 20 mg H ₂ O / L

Reaction Principle

- $\text{CH}_2=\text{CHCl} + \text{Cr}^{\text{VI}} \rightarrow \text{Cl}_2$
- $\text{Cl}_2 + \text{dimethyl naphthidine} \rightarrow \text{violet reaction product}$

Cross Sensitivity

100 ppm hydrogen chloride, 20 ppm chlorine, 10 ppm carbon tetrachloride, 10 ppm chloroform or 5 ppm perchloroethylene are not indicated.

Trichloroethylene and chlorobenzene are indicated with less sensitivity.

1,1-dichloroethylene is indicated with almost identical sensitivity.

Vapors of organic solvents consume part of the oxidation layer so that the resultant reading is somewhat lower.

Examples: a reading of 0.5 ppm vinyl chloride will occur by

5 ppm vinyl chloride + 100 ppm butadiene or

5 ppm vinyl chloride + 10 ppm ethylene

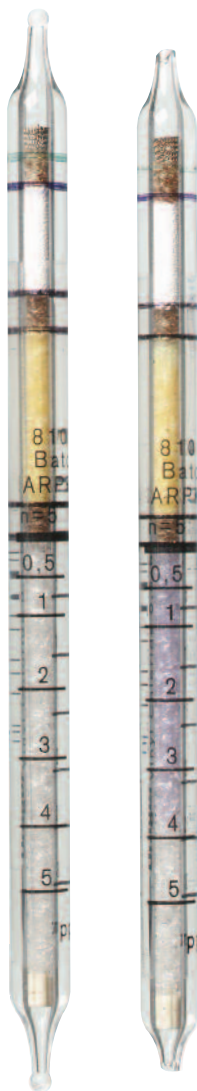

ST-159-2001

Vinyl Chloride 100/a

Order No. CH 19 601

Application Range

Standard Measuring Range:	100 to 3,000 ppm
Number of Strokes n:	18 to 1
Time for Measurement:	max. 3 min
Standard Deviation:	± 30 %
Color Change:	violet → light brown

Ambient Operating Conditions

Temperature:	0 to 40 °C
Absolute Humidity:	< 30 mg H ₂ O / L

Reaction Principle

$$\text{CH}_2=\text{CHCl} + \text{MnO}_4^- \rightarrow \text{Mn}^{\text{IV}} + \text{various oxidation products}$$

Cross Sensitivity

Many organic compounds with C=C double bonds are indicated, but with different sensitivities. It is impossible to differentiate between them. It is impossible to measure vinyl chloride in the presence of dialkyl sulfide.



SF-16/2001

Water Vapor 0.1

Order No. CH 23 401

V

Application Range

Standard Measuring Range:	1 to 40 mg/L
Number of Strokes n:	10
Time for Measurement:	approx. 2 min
Standard Deviation:	± 10 to 15 %
Color Change:	yellow → red brown

Ambient Operating Conditions

Temperature:	0 to 40 °C
--------------	------------

Reaction Principle

$\text{H}_2\text{O} + \text{SeO}_2 + \text{H}_2\text{SO}_4 \rightarrow$ reddish brown reaction product

Cross Sensitivity

Low molecular weight alcohols are indicated. A variety of other organic compounds, such as petroleum hydrocarbons are indicated.

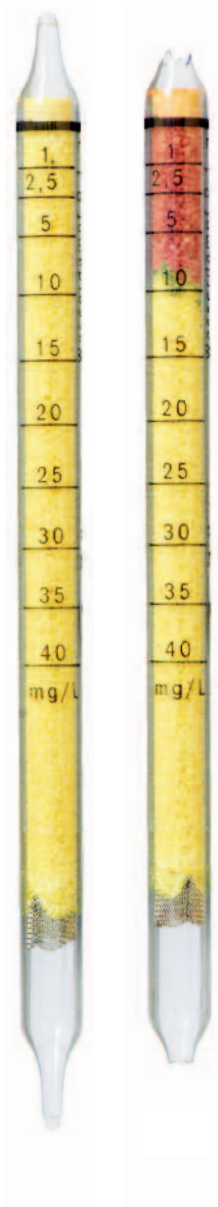

Water Vapor 0.1/a

Order No. 81 01 321

Application Range

Standard Measuring Range:	0.1 to 1.0 mg/L
Number of Strokes n:	3
Time for Measurement:	approx. 1.5 min
Standard Deviation:	± 15 to 20 %
Color Change:	yellow → blue

Ambient Operating Conditions

Temperature:	0 to 30 °C
--------------	------------

Reaction Principle

$\text{H}_2\text{O} + \text{Mg}(\text{ClO}_4)_2 \rightarrow \text{blue reaction product}$

Cross Sensitivity

Generally basic substances cause plus errors and acidic substances cause minus errors.

No interference by:

1,200 ppm nitrogen dioxide

6,000 ppm sulfur dioxide

2,000 ppm ethanol

2,000 ppm acetone

Additional Information

The first scale mark corresponds to 0.05 mg H₂O / L



Water Vapor 1/b

Order No. 81 01 781

W

Application Range

Standard Measuring Range:	20 to 40 mg/L	/ 1 to 18 mg/L
Number of Strokes n:	1	/ 2
Time for Measurement:	approx. 20 s	/ approx. 40 s
Standard Deviation:	± 15 to 20 %	
Color Change:	yellow → turquoise-blue	

Ambient Operating Conditions

Temperature:	0 to 50 °C
Absolute Humidity:	up to 100% r.h.
Condensation in the tube causes measurement errors. If high r.h. (in excess of 80%) is to be expected, the temperature of the tube should be at least 5 °C higher than ambient temperature. Given a r.h. below 80%, the temperature of the tube should be at least equal to the ambient temperature.	

Reaction Principle

$\text{H}_2\text{O} + \text{Mg}(\text{ClO}_4)_2 \rightarrow \text{turquoise-blue reaction product}$

Cross Sensitivity

Acid gases are liable to cause plus errors. Basic gases are liable to cause minus errors.

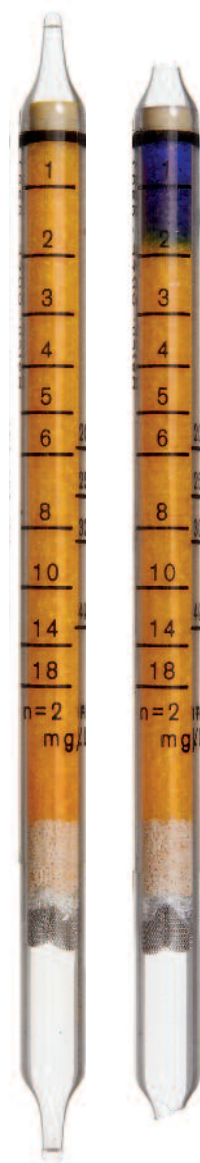

D-13326-2010

Xylene 10/a

Order No. 67 33 161

Application Range

Standard Measuring Range:	10 to 400 ppm
Number of Strokes n:	5
Time for Measurement:	approx. 1 min.
Standard Deviation:	± 20 to 30 %
Color Change:	white → red brown

Ambient Operating Conditions

Temperature:	0 to 40 °C
Absolute Humidity:	3 to 15 mg H ₂ O / L

Reaction Principle



Cross Sensitivity

Styrene, vinyl acetate, toluene, ethyl benzene and acetaldehyde are indicated, but with different sensitivities.

No interference by:

500 ppm octane

200 ppm methanol

400 ppm ethyl acetate

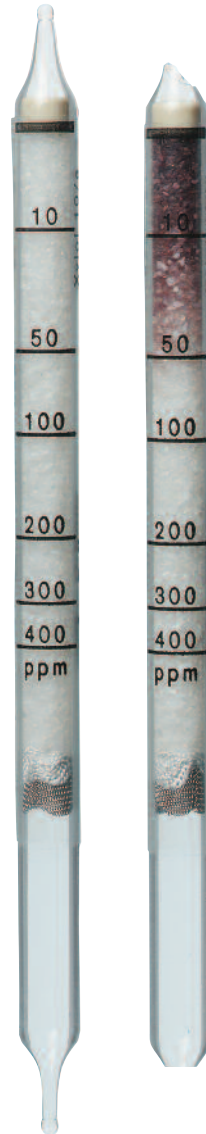

5.1.3 Data about Dräger Simultaneous Test Set

Simultaneous Test-Set I for inorganic fumes

Order No. 81 01 735

Application Range

Standard Measuring Range and Color Change:

Dräger-Tubes in Simultaneous Test-Set I	1. Scale Mark ppm	2. Scale Mark ppm
1. Acid gas blue → yellow	Hydrochloric Acid	
	5	25
2. Hydrocyanic acid yellow → red	10	50
3. Carbon Monoxide white → brown green	30	150
4. Basic gas yellow → blue	Ammonia	
	50	250
5. Nitrous gas pale grey → blue grey	Nitrogen Dioxide	
	5	25
Number of Strokes n:	10	
Time for Measurement:	approx. 40 s	



ST-238-2001



ST-237-2001

Ambient Operating Conditions

Temperature:	10 to 30 °C
Absolute Humidity:	5 to 15 mg H ₂ O / L
Semi-quantitative measurements are also possible outside this range. Water aerosols may result in minus errors.	

Attention

The Simultaneous Test Set was developed for the semi-quantitative measurement of fumes and decomposition gases. It is used to estimate and limit risks by obtaining information about health risks or possible intoxication hazards in the area of a fire.

The Simultaneous Test Set cannot be used to determine the risk of explosion. A negative result with the Simultaneous Test Set does not exclude the presence of other hazardous gases.

Simultaneous Test-Set II for inorganic fumes

Order No. 81 01 736

S

Application Range

Standard Measuring Range and Color Change:

Dräger-Tubes in Simultaneous Test-Set II	1. Scale Mark ppm	2. Scale Mark ppm
1. Sulfur Dioxide blue → white	–	10
2. Chlorine white → orange	–	2.5
3. Hydrogen Sulfide white → pale brown	10	50
4. Phosphine yellow → red	–	0.3
5. Phosgene white → red	–	0.5
Number of Strokes n:	10	
Time for Measurement:	approx. 40 s	



D-18326-2010



D-18326-2010

Ambient Operating Conditions

Temperature: 10 to 30 °C
 Absolute Humidity: 5 to 15 mg H₂O / L
 Semi-quantitative measurements are also possible outside this range. Water aerosols may result in minus errors.

Attention

The Simultaneous Test Set was developed for the semi-quantitative measurement of fumes and decomposition gases. It is used to estimate and limit risks by obtaining information about health risks or possible intoxication hazards in the area of a fire. The Simultaneous Test Set cannot be used to determine the risk of explosion. A negative result with the Simultaneous Test Set does not exclude the presence of other hazardous gases.

Simultaneous Test Set Fumigation I

Order No. 81 03 410

Application Range

Standard Measuring Range and Color Change:

Dräger tube in Simultaneous Test Set Fumigation

	Scale Mark
1. Formaldehyde white → pink	1 ppm
2. Phosphine yellow → red	0.1 ppm
3. Hydrocyanic Acid yellow → red	10 ppm
4. Methyl Bromide green → brown	5 ppm
5. Ammonia yellow → blue	50 ppm

Number of strokes n: 50

Measurement period: approx. 3 min.

Ambient Operating Conditions

Temperature: 10 to 30 °C

Absolute Humidity: 5 to 15 mg H₂O / L

Measurement outside the given temperature and humidity may affect sensitivities. Water-aerosols can produce minus error.

Attention

The Simultaneous Test was developed for the semi-quantitative measurement. The Simultaneous Test has not been designed for detection of explosion hazards. If the simultaneous tests indicate negative results (substance is not present), the presence of other dangerous substances can not be excluded.

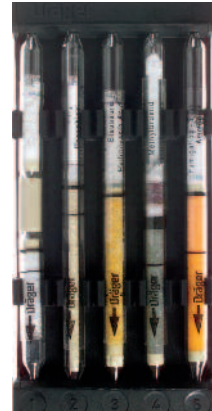

ST-942/2008



Simult_1

Simultaneous Test Set Fumigation II

Order No. 81 03 380

S

Application Range

Standard Measuring: Range

Substance	Sensitivity	Color Change
Formaldehyde	1 ppm	white → pink
Phospine	0,3 ppm	yellow → red
Hydrocyanic Acid	10 ppm	yellow → red
Methylbromide	0,5 ppm	green → brown
Ethylenoxide	1 ppm	white → pink

Number of strokes n:	50
Measurement period:	approx. 4 min

Ambient Operating Conditions

Temperature:	10 to 40 °C
Absolute Humidity:	5 to 40 mg H ₂ O / L

Attention

The Simultaneous Test Set was developed for the semi-quantitative measurement of organic vapors. It is used to estimate and limit risks by obtaining information about health risks or possible intoxication hazards in the area of a fire.

The Simultaneous Test Set cannot be used to determine the risk of explosion. A negative result with the Simultaneous Test Set does not exclude the presence of other hazardous gases.



ST-5786-2004

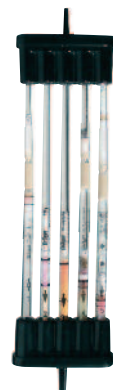

ST-5787-2004

Simultaneous Test Set Conductive Compounds 10/01

Order No. 81 03 170

Application Range

Standard Measuring Range and Color Change:

Dräger tube in	1. marking ETW
Simultaneous Test Set	(tolerance value for fire-fighters)
1. Carbon monoxide (CO)	33 ppm
white → brown green	
2. Hydrocyanic acid	3.5 ppm
yellow → red	
3. Hydrochloric acid	5.4 ppm
blue → yellow	
4. Nitrous gases (nitrogen oxides)	8.2 ppm
pale grey → blue grey	
5. Formaldehyde	1 ppm
white → pink	

Number of strokes n: 20

Measurement period: approx. 2 min

Ambient Operating Conditions

Temperature: 5 to 30 °C

Absolute Humidity: 5 to 15 mg H₂O / L

Semi-quantitative measurements are also possible outside this range. Water aerosols may result in minus errors.

Attention

The Simultaneous Test Set was developed for the semi-quantitative measurement of fumes and decomposition gases. It is used to estimate and limit risks by obtaining information about health risks or possible intoxication hazards in the area of a fire.

The Simultaneous Test Set cannot be used to determine the risk of explosion. A negative result with the Simultaneous Test Set does not exclude the presence of other hazardous gases.



ST-583-2008



ST-594-2008

Simultaneous Test-Set III for organic vapors

Order No. 81 01 770

S

Application Range

Standard Measuring Range and Color Change:

Dräger-Tubes in Simultaneous Test-Set III	1. Scale Mark ppm	2. Scale Mark ppm
1. Ketones pale yellow → dark yellow	1,000	5,000
2. Aromatics white → brown	100	500
3. Alcohols orange → green brown	200	1,000
4. Aliphatics white → brown	50	100
5. Chlorinated hydrocarbons yellow white → grey blue	50	100
Number of Strokes n:	10	
Time for Measurement:	approx. 40 s	



Ambient Operating Conditions

Temperature: 10 to 30 °C

Absolute Humidity: 5 to 15 mg H₂O / L

The ranges given for temperature and humidity apply to calibrations with the original substances. Semi-quantitative measurements are also possible outside this range.

Attention

The Simultaneous Test Set was developed for the semi-quantitative measurement of organic vapors. It is used to estimate and limit risks by obtaining information about health risks or possible intoxication hazards in the area of a fire.

The Simultaneous Test Set cannot be used to determine the risk of explosion. A negative result with the Simultaneous Test Set does not exclude the presence of other hazardous gases.

5.1.4 Data about Dräger-Tubes for Military Applications

CDS – Simultaneous-Test-Set I

Order No. 81 03 140

Application Range

Qualitative measurement of volatile substances that may be present at warfare-related materials toxic waste sites.

Substance	Sensitivity
Thioether (Sulfur Mustard)	1 mg/m ³
Phosgene	0.2 ppm (approx. 20 mm pale green)
Hydrocyanic Acid (HCN)	1 ppm
Org. Arsenic Compounds and Arsine	0.1 ppm Arsine, (3 mg/m ³ org. arsenic compounds)
Organic Basic Nitrogen Comp.	1 mg/m ³

Number of Strokes n:	50
Time for Measurement:	approx. 3 min

Ambient Operating Conditions

Temperature:	5 to 30 °C
Humidity:	5 to 15 mg H ₂ O / L
Measurement outside the given temperature and humidity ranges may affect sensitivities. Water-aerosols can produce minus errors.	



Reading Evaluation: Attention! Follow Instructions in Detail!

1. Thioether (Sulfur Mustard)

Color band: yellow → orange

Cross sensitivity: Various thioethers can be indicated, differentiation among thioethers is not possible.

2. Phosgene

Color band: yellow → blue-green

Cross sensitivity: Hydrochloric acid does not affect the indication up to 100 ppm.

3. Hydrocyanic Acid

Color band: yellow-orange → red

Cross sensitivity: 100 ppm hydrogen sulfide, 300 ppm ammonia, 200 ppm sulfur dioxide, 50 ppm nitrogen dioxide, 1000 ppm acrylonitrile as well as 1000 ppm hydrochloric acid does not affect the indication. Hydrogen sulfide colors the indicator dark brown, but has no influence on the hydrogen cyanide indicator.

4. Organic Arsenic Compounds and Arsine

Color band: pale yellow → grey

Cross sensitivity: Phosphorous hydride can appear before the ampoule is opened, however it reacts with mixed sensitivity.

5. Organic Basic Nitrogen Compounds

Color band: yellow → orange-red

Cross sensitivity: Various organic basic nitrogen compounds will be indicated, differentiation is not possible.

CDS – Simultaneous-Test-Set II

Order No. 81 03 150

Application Range

Qualitative measurement of volatile substances that may be present at warfare-related materials toxic waste sites.

Substance	Sensitivity
Cyanogen Chloride	0.25 ppm
Thioether (Sulfur Mustard)	1 mg/m ³
Phosgene	0.2 ppm (approx. 20 mm pale green)
Hydrocyanic Acid (HCN)	1 ppm
Phosphoric Acid Ester	0.025 ppm Dichlorovos
Number of Strokes n:	50
Time for Measurement:	approx. 3 min



D-13333-2010

Ambient Operating Conditions

Temperature:	5 to 30 °C
Humidity:	5 to 15 mg H ₂ O / L
Measurement outside the given temperature and humidity ranges may affect sensitivities. Water-aerosols can produce minus errors.	



D-13334-2010

Reading Evaluation: Attention! Follow Instructions in Detail!

1. Cyanogen Chloride

Color band: white → pink

Cross sensitivity: Cyanogen bromide is also indicated, but with different sensitivity.

2. Thioether (Sulfur Mustard)

Color band: yellow → orange

Cross sensitivity: Various thioethers can be indicated, differentiation among thioethers is not possible.

3. Phosgene

Color band: yellow → blue-green

Cross sensitivity: Hydrochloric acid does not affect the indication up to 100 ppm.

4. Hydrocyanic Acid

Color band: yellow-orange → red

Cross sensitivity: 100 ppm hydrogen sulfide, 300 ppm ammonia, 200 ppm sulfur dioxide, 50 ppm nitrogen dioxide, 1000 ppm acrylonitrile as well as 1000 ppm hydrochloric acid does not affect the indication. Hydrogen sulfide colors the indicator dark brown, but has no influence on the hydrogen cyanide indicator.

5. Phosphoric Acid Ester

Color band: yellow → red (min. 1 min)

Cross sensitivity: Other Phosphoric acid esters will also be indicated, but with different sensitivities.

CDS – Simultaneous-Test-Set III

Order No. 81 03 160

Application Range

Qualitative measurement of volatile substances that may be present at warfare-related materials toxic waste sites.

Substance	Sensitivity
Thioether (Sulfur Mustard)	1 mg/m ³
Org. Basic Nitrogen Compounds	1 mg/m ³
Phosphoric Acid Ester	0.025 ppm Dichlorovos
Hydrocyanic Acid (HCN)	1 ppm
Org. Arsenic Compounds and Arsine	0.1 ppm Arsine, (3 mg/m ³ org. arsenic compounds)
Number of Strokes n:	50
Time for Measurement:	approx. 3 min

Ambient Operating Conditions

Temperature: 5 to 30 °C
 Humidity: 5 to 15 mg H₂O / L
 Measurement outside the given temperature and humidity ranges may affect sensitivities. Water-aerosols can produce minus errors.



ST-327-2008



ST-334-2008

Reading Evaluation: Attention! Follow Instructions in Detail!

1. Thioether (Sulfur Mustard)

Color band: yellow → orange

Cross sensitivity: Various thioethers can be indicated, differentiation among thioethers is not possible.

2. Organic Basic Nitrogen Compounds

Color band: yellow → orange-red

Cross sensitivity: Various organic basic nitrogen compounds will be indicated, differentiation is not possible.

3. Phosphoric Acid Ester

Color band: yellow → red
(min. 1 min)

Cross sensitivity: Other Phosphoric acid esters will also be indicated, but with different sensitivities.

4. Hydrocyanic Acid

Color band: yellow-orange → red

Cross sensitivity: 100 ppm hydrogen sulfide, 300 ppm ammonia, 200 ppm sulfur dioxide, 50 ppm nitrogen dioxide, 1000 ppm acrylonitrile as well as 1000 ppm hydrochloric acid does not affect the indication. Hydrogen sulfide colors the indicator dark brown, but has no influence on the hydrogen cyanide indicator.

5. Organic Arsenic Compounds and Arsine

Color band: yellow → grey

Cross sensitivity: Phosphorous hydride can appear before the ampoule is opened, however it reacts with mixed sensitivity.

CDS – Simultaneous-Test-Set V

Order No. 81 03 200

Application Range

Qualitative measurement of volatile substances that may be present at warfare-related materials toxic waste sites.

Substance	Sensitivity
Cyanogen Chloride	0.25 ppm
Thioether (Sulfur Mustard)	1 mg/m ³
Phosgene	0.2 ppm (approx. 20 mm pale green)
Chlorine (Cl ₂)	0.2 ppm
Phosphoric Acid Ester	0.025 ppm Dichlorovos
Number of Strokes n:	50
Time for Measurement:	approx. 3 min



D-193395-2010

Ambient Operating Conditions

Temperature: 5 to 30 °C

Humidity: 5 to 15 mg H₂O / L

Measurement outside the given temperature and humidity ranges may affect sensitivities. Water-aerosols can produce minus errors.



D-193396-2010

Reading Evaluation: Attention! Follow Instructions in Detail!

1. Cyanogen Chloride

Color band: white → pink

Cross sensitivity: Cyanogen bromide is also indicated, but with different sensitivity.

2. Thioether (Sulfur Mustard)

Color band: yellow → orange

Cross sensitivity: Various thioethers can be indicated, differentiation among thioethers is not possible.

3. Phosgene

Color band: yellow → blue-green

Cross sensitivity: Hydrochloric acid does not affect the indication up to 100 ppm.

4. Chlorine

Color band: white → yellow-orange

Cross sensitivity: Bromide and nitrogen dioxide will also be indicated, but with different sensitivities.

5. Phosphoric Acid Ester

Color band: yellow → red
(min. 1 min)

Cross sensitivity: Other Phosphoric acid esters will also be indicated, but with different sensitivities.

Org. Arsenic Compounds and Arsine

Order No. CH 26 303

Application Range

Standard Measuring Range:	Qualitative 0.1 ppm Arsine and 3 mg org. arsenic/m ³ are the minimum detectable concentrations.
Number of Strokes n:	8
Time for Measurement:	max. 3 min
Standard Deviation:	± 50 %
Color Change:	yellow → grey

Ambient Operating Conditions

Temperature:	0 to 40 °C
Absolute Humidity:	< 50 mg H ₂ O / L

Reaction Principle

- a) $\text{AsR}_3 + \text{Zn}/\text{HCl} \rightarrow \text{AsH}_3$
 b) $\text{AsH}_3 + \text{Au}/\text{Hg-complex} \rightarrow \text{Au (colloidal)}$

Cross Sensitivity

Phosphine and arsine are indicated before the ampoule is broken, but with different sensitivities.

Additional Information

Arsine is present if a grey ring appears in the indicating layer after performing 8 pump strokes. If there is no indication, the ampoule must be broken and the liquid transferred onto the indicating layer such that it is completely saturated. Then an additional eight pump strokes must be performed.



ST-17-2001

Organic Basic Nitrogen Compounds

Order No. CH 25 903

Application Range

Standard Measuring Range:	1 mg/m ³ corresponds to a discoloration of 1 to 2 mm in length.
Number of Strokes n:	8
Time for Measurement:	approx. 1.5 min
Standard Deviation:	± 50 %
Color Change:	yellow → orange red

Ambient Operating Conditions

Temperature:	0 to 40 °C
Absolute Humidity:	< 50 mg H ₂ O / L

Reaction Principle

$\text{NR}_3 + \text{KBil}_4 \rightarrow \text{orange red reaction product}$

Cross Sensitivity

Various organic basic nitrogen compounds are indicated. It is impossible to differentiate between them.



SI-77-2001

Phosphoric Acid Esters 0.05/a

Order No. 67 28 461

Application Range

Standard Measuring Range:	0.05 ppm Dichlorvos
Number of Strokes n:	10
Time for Measurement:	approx. 5 min
Standard Deviation:	± 30 %
Color Change:	yellow → red

Ambient Operating Conditions

Temperature:	10 to 40 °C
Absolute Humidity:	3 to 18 mg H ₂ O / L

Reaction Principle

- $(\text{CH}_3)_2\text{PO}_2\text{-CH=CCl}_2 + \text{Cholinesterase} \rightarrow \text{inactive enzyme}$
- Butyrylcholine iodide + H₂O → Butyric acid
- Butyric acid + Phenol red → yellow reaction product

If phosphoric acid esters are present the enzyme is inactivated and butyric acid will not form, thus the weak alkali solution colors the indicating layer red and must be stable for 1min. If the enzyme remains active, phosphoric acid esters are not present, and the indicating layer remains yellow because of butyric acid formation.

Cross Sensitivity

Other phosphoric acid esters than dichlorvos are also indicated, but with different sensitivities.

Additional Information

After performing the required 10 pump strokes the reagent ampoule must be broken and the liquid transferred to the enzyme layer by gently tapping the side of the tube. The substrate layer must not become wet. After waiting one (1) minute the liquid must be carefully drawn up to the marking line using the pump. Wait another minute before drawing the liquid onto the indication layer using the pump.



ST-144-2001

5.1.5 Data about Dräger-Tubes used with Dräger Aerotest

Ammonia 2/a for use in Aerotest CO₂

Order No. 67 33 231

Application Range

Use in Aerotest CO₂

Standard Measuring Range: 0.6 to 9 ppm

Test Volume: 1 L

Flow Rate: 0,2 L / min

Time for Measurement: 5 min

Standard Deviation: ± 25%

Color Change: yellow → blue

Ambient Operating Conditions

Temperature: 10 to 50 °C

Absolute Humidity: < 20 mg H₂O / L

Pressure: The tube may only be used
for depressurized compressed
air

Reaction Principle

NH₂ + pH-indicator → blue reaction product

Cross Sensitivity

Other basic substances such as organic amines are indicated as well.

The indication is not affected by

300 ppm nitrous fumes

2,000 ppm sulfuric dioxide

2,000 ppm hydrogen sulfide

Evaluation

Reading on scale x 0.3 = ppm ammonia



Carbon Dioxide 100/a-P

Order No. 67 28 521

Application Range

Use in Aerotest 5000, Aerotest Alpha, MultiTest med. Int.,
Aerotest HP

Standard Measuring Range: 100 to 3,000 ppm

Test Volume: 1 L

Flow Rate: 0,2 L / min

Time for Measurement: approx. 5 min

Standard Deviation: ± 10 to 15 %

Color Change: white \rightarrow violet

Ambient Operating Conditions

Temperature: 15 to 25 °C

Absolute Humidity: max. 23 mg H₂O / L

Pressure: The tube may only be
used for depressurized
compressed air

Reaction Principle

$\text{CO}_2 + \text{N}_2\text{H}_4 \rightarrow \text{NH}_2\text{-NH-COOH}$ Crystal violet

Cross Sensitivity

Hydrogen sulfide and sulfur dioxide in the TLV range are not
indicated.



ST-51-2001

Carbon Monoxide 5/a-P

Order No. 67 28 511

Application Range

Use in Aerotest 5000, Aerotest Alpha, MultiTest med. Int.,

Aerotest Simultaneous HP, Simultantest CO₂

Standard Measuring Range:	5 to 150 ppm
Test Volume:	1 L
Flow Rate:	0.2 L / min
Time for Measurement:	approx. 5 min
Standard Deviation:	± 10 to 15 %
Color Change:	white → brownish-green

Ambient Operating Conditions

Temperature:	0 to 40 °C
Absolute Humidity:	0 to 50 mg H ₂ O / L
Pressure:	The tube may only be used for depressurized compressed air

Reaction Principle

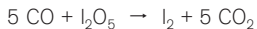

Cross Sensitivity

Acetylene reacts similarly to carbon monoxide but with less sensitivity.

Petrol, benzene, halogenated hydrocarbons and hydrogen sulfide are retained in the pre-layer.

Higher concentrations of easily cleavable halogenated hydrocarbons (e.g. trichloroethylene) may form chromyl chloride in the pre-layer which changes the indicating layer to yellowish-brown.

In case of high olefine concentrations it is not possible to measure carbon monoxide.

Extension of the Measuring Range

Using a test volume of 2 L divide the reading by 2, measuring range 2,5 to 75 ppm.



SF-71/2001

Hydrogen Sulfide 0.2/a

Order No. 81 01 461

Application Range

Use in Aerotest Simultaneous CO₂

Standard Measuring Range: 0.04 to 1 ppm

Test Volume: 4 L

Flow Rate: 0.8 L / min

Time for Measurement: 5 min

Standard Deviation: ± 25 %

Color Change: white → palebrown

Ambient Operating Conditions

Temperature: 10 to 30 °C

Absolute Humidity: max. 15 mg H₂O / L

Pressure: The tube may only be used for depressurized compressed air

Reaction Principle

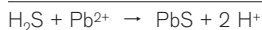

Cross Sensitivity

Sulfur dioxide and hydrochloric acid in the TLV range do not affect the reading.

Evaluation

$$\frac{\text{Scale reading}}{5} = \text{ppm H}_2\text{S}$$

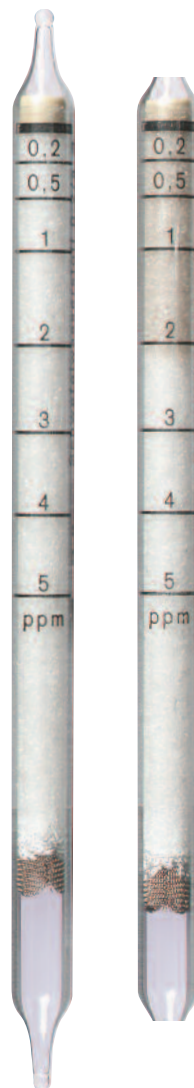

ST-102-2001

Hydrogen Sulfide 1/d

Order No. 81 01 831

Application Range

Use in MultiTest med. Int.

Standard Measuring Range:	1 to 20 ppm
Test Volume:	1 L
Flow Rate:	0.17 L / min (CO ₂)
Time for Measurement:	6 min
Standard Deviation:	± 15 %
Color Change:	white → brown

Ambient Operating Conditions

Temperature:	2 to 40 °C
Absolute Humidity:	max 40 mg H ₂ O / L
Pressure:	The tube may only be used for depressurized compressed air

Reaction Principle



Cross Sensitivity

500 ppm hydrochloric acid, 500 ppm sulfur dioxide, 500 ppm ammonia or 100 ppm arsine do not affect the indication. Methyl mercaptan and ethyl mercaptan change the entire indicating layer to a pale yellow. when mixed with hydrogen sulfide the reading is extended by approx. 30 %.

Evaluation

reading on the (n= 10)	scale = ppm H ₂ S
------------------------	------------------------------

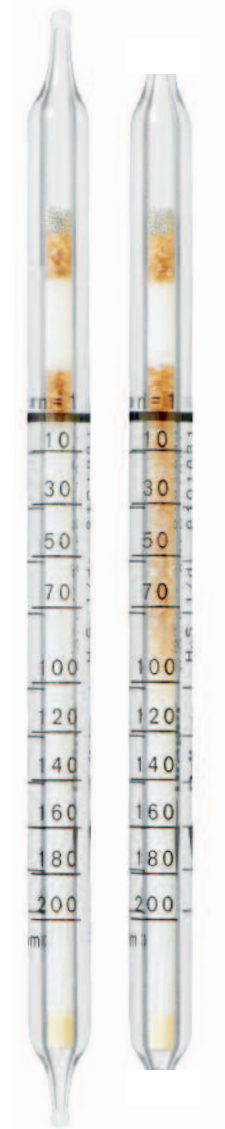

Impactor, Measurement of Oil Mist

Order No. 81 03 560

Application Range

Use in Aerotest 5000, Aerotest Alpha, MultiTest med. Int.,
Aerotest Simultaneous HP

Standard Measuring Range:	0.1 mg/m ³ , 0.5 mg/m ³ , 1.0 mg/m ³ Oil mist (Oil Aerosols)
Detection Limit:	0,05 mg/m ³ Oil mist
Test Volume:	20 L
Volumenstrom:	4 L/min
Time for Measurement:	5 min
Evaluation:	see details in operating instructions for Impactor

Ambient Operating Conditions

Temperature:	10 to 30 °C
Humidity:	max. 60 % r. h.
Pressure:	only to be used for unstressed compressed air

Reaction Principle

Compressed air is guided through the Impactor vertically onto a baffle plate made of cut glass. A 90 ° re-direction of the air flow in the Impactor separates the oil aerosols. The aerosols flow directly onto the glass plate caused by the high inertia of the aerosols. The recesses in the glass are filled with the oil aerosols and the light dispersed by the glass grinding is compensated.

Cross Sensitivity

The measurement result is not dependent on the oil grade. However, it must be noted that oil aerosols evaporate at higher temperatures. Oil vapor is not displayed.

Additional Information

The Impactor has to be used together with the Adapter of the Impactor (Order No. 81 03 557) in conjunction with the Dräger Aerotest Simultan.

ST-357-2008



Dräger Impactor

ST-1220-2008

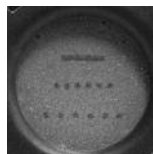

0.1 mg/m³

ST-1231-2008

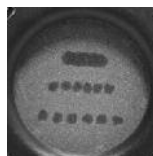

0.5 mg/m³

ST-1232-2008



1.0 mg/m³

ST-604-2008



Adapter of the Impactor

ST-602-2008



Adapter with Impactor
connected in Dräger
Aerotest Simultan

Nitrous Fumes 0.2/a

Order No. 81 03 661

Application Range

Use in MultiTest med. Int., Simultaneous CO ₂	
Standard Measuring Range:	0.2 to 6 ppm
Test Volume:	1 L
Flow Rate:	0.2 L/min.
Time for Measurement:	5 min
Standard Deviation:	± 30 %
Color Change:	grey green → blue grey

Ambient Operating Conditions

Temperature:	10 to 40 °C
Absolute Humidity:	max. 40 mg H ₂ O / L
Pressure:	The tube may only be used for depressurized compressed air

Reaction Principle

- $\text{NO} + \text{Cr}^{\text{VI}} \rightarrow \text{NO}_2$
- $\text{NO}_2 + \text{Diphenylbenzidine} \rightarrow \text{blue grey reaction product}$

Cross Sensitivity

It is impossible to measure nitrous fumes in the presence of ozon and/or chlorine in excess of their TLV's, these gases are also indicated with different sensitivity. Nitrogen dioxide concentration above 300 ppm can bleach the indication.

Evaluation

Scale reading = ppm nitrous fumes

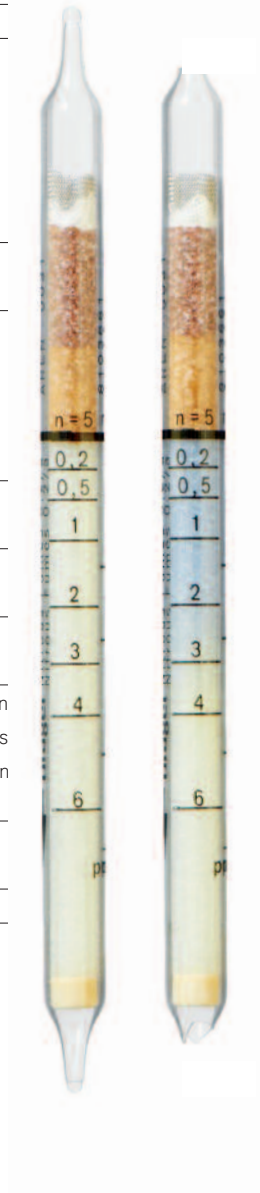

D-54882/014

Oil 10/a-P

Order No. 67 28 371

Application Range

Use in Aerotest 5000, Aerotest Alpha, MultiTest med. Int.,	
Standard Measuring Range:	0.1 to 1 mg/m ³
Time for Measurement:	(see details in
Standard Deviation:	operating instructions for Aerotest)
Color Change:	white → pale beige or yellow

Ambient Operating Conditions

Temperature:	10 to 30 °C
Absolute Humidity:	see details in operating instructions for Aerotest
Pressure:	The tube may only be used for depressurized compressed air

Reaction Principle

Oil + H₂SO₄ → beige-yellow reaction product

Cross Sensitivity

The total concentration of mineral and synthetic aerosols (mist) and oil vapors is indicated.

Other organic compounds with high molecular weights are indicated as well but with different sensitivity.

Polyethylene glycol and silicone oils are not indicated.

Additional Information

In combination with a Dräger gas detector pump the oil tube can also be used to analyse the air in work rooms. The measurement period depends upon the oil used. Please find a list of the oils tested under www.draeger.com/voice.



ST-143-2001

Phosphine 0.1/a

Order No. CH 31 101

Application Range

Use in Simultaneous CO₂

Standard Measuring Range: 0.1 to 4 ppm

Test Volume: 1 L

Flow Rate: 0.2 L / min

Time for Measurement: 5 min

Standard Deviation: ± 15 to 20 %

Color Change: white → greyviolet

Ambient Operating Conditions

Temperature: 0 to 50 °C

Absolute Humidity: max 40 mg H₂O / L

Pressure: The tube may only be
used for depressurized
compressed air

Reaction Principle

$$\text{PH}_3 + \text{Au}^{3+} \rightarrow \text{Au (colloidal)}$$

Cross Sensitivity

Arsine and antimony hydride are indicated, but with different sensitivities. Hydrogen sulfide, mercaptans, ammonia, carbon monoxide, sulfur dioxide and hydrochloric acid in the TLV range do not interfere.

Evaluation

Scale reading = ppm phosphine

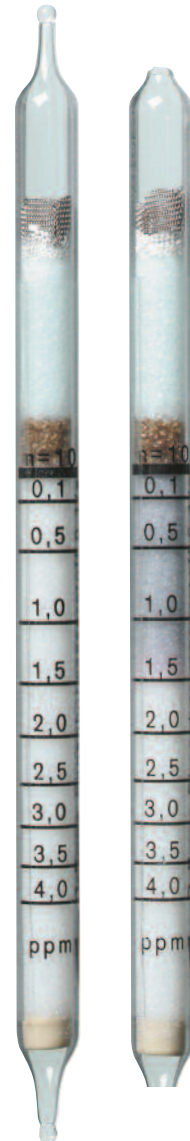

ST-112-2001

Sulfur Dioxide 0.5/a

Order No. 67 28 491

Application Range

Use in MultiTest med. Int.

Standard Measuring Range: 1 to 25 ppm / 0.25 to 1 ppm

Test Volume: 1 L / 2 L

Flow Rate: 0.2 L / 0.2 L / min

Time for Measurement: 5 min / 10 min

Standard Deviation: $\pm 25 \%$

Color Change: greyblue \rightarrow white

Ambient Operating Conditions

Temperature: 15 to 30 °C

Absolute Humidity: max. 20 mg H₂O / L

Pressure: The tube may only be used
for depressurized compressed
air

Reaction Principle

Starch

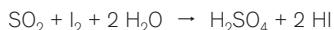

Cross Sensitivity

Hydrogen sulfide is indicated as well but with different sensitivity.

Nitrogen dioxide will shorten the reading.

Evaluation

Measuring range 1 to 25 ppm: Reading on the (n=10)
scale = ppm

Measuring range 0.25 to 1 ppm: Reading on the (n= 20) scale x
0.5 = ppm SO₂
(applies only for scale range 0.5
to 2 ppm)



ST-121-2001

Sulfur Dioxide 1/a

Order No. CH 31 701

Application Range

Use in Simultaneous CO₂

Standard Measuring Range:	0.5 to 2 ppm
Test Volume:	2 L
Flow Rate:	approx. 0.2 L / min
Time for Measurement:	in the Aerotest CO ₂ : 10 min in the Multi Test (for CO ₂): 12 min
Standard Deviation:	± 30 %
Color Change:	greyblue → white

Ambient Operating Conditions

Temperature:	15 to 25 °C
Absolute Humidity:	3 to 20 mg H ₂ O / L
Pressure:	The tube may only be used for depressurized compressed air

Reaction Principle

Starch

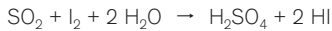

Cross Sensitivity

Hydrogen sulfide in the TLV range is retained in the pre-layer and thus does not affect the indication. Nitrogen dioxide will shorten the reading.

Evaluation

reading on the (n=10) scale x 0.2 = ppm SO₂
(applies only for scale range 2.5 to 10 ppm)

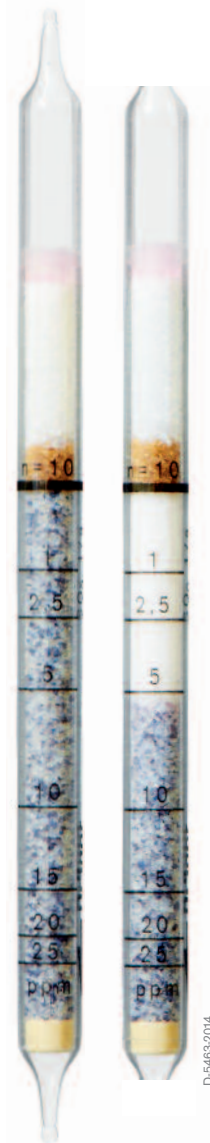

Water Vapor 5/a-P

Order No. 67 28 531

Application Range

Use in Aerotest 5000, Simultaneous CO₂

Standard Measuring Range:	5 to 200 mg/m ³
Test Volume:	50 L
Flow Rate:	2 L / min
Time for Measurement:	approx. 25 min
Standard Deviation:	± 15 to 20 %
Color Change:	yellow → reddish-brown

Ambient Operating Conditions

Temperature:	0 to 40 °C
Pressure:	The tube may only be used for depressurized compressed air

Reaction Principle

$\text{H}_2\text{O} + \text{SeO}_2 + \text{H}_2\text{SO}_4 \rightarrow$ reddish-brown reaction product

Cross Sensitivity

Alcohols and unsaturated hydrocarbons of high concentrations may cause a diffused discoloration of the indicating layer.

Extension of the measuring range

The following evaluation applies for other volumes:

reading:	5	10	30	50	70	100	150	200 mg H ₂ O/m ³
25 L vol.:	10	20	70	110	160	220	340	450 mg H ₂ O/m ³
100 L vol.:	2	4	12	20	28	40	60	80 mg H ₂ O/m ³

i.e. given a test volume of 25 L the scale reading of 50 mg H₂O/m³ corresponds to a measured value of 110 mg H₂O/m³

Relative Standard Deviation:	± 25 to 30 % (25 L)
	± 20 to 25 % (100 L)



D-1244-2009

Water Vapor 20/a-P

Order No. 81 03 061

Application Range

Use in Aerotest Alpha, MultiTest med. Int.,

Aerotest Simultaneous HP

Standard Measuring Range:	20 to 250 / 35 to 500 / 150 to 1500 mg H ₂ O/m ³
Test Volume:	40 L / 20 L
Flow Rate:	4 L / min
Time for Measurement:	10 min. / 5 min. / 2.5 min.
Standard Deviation:	± 15 to 20 %
Color Change:	yellow → red-brown

Ambient Operating Conditions

Temperature:	0 to 40 °C
Humidity:	cf. measuring range
Pressure:	The tube may only be used for depressurized compressed air

Reaction Principle

$$\text{H}_2\text{O} + \text{SeO}_2 + \text{H}_2\text{SO}_4 \rightarrow \text{reddish brown reaction product}$$

Cross Sensitivity

Alcohols and unsaturated hydrocarbons of high concentrations may cause a diffused discoloration of the indicating layer.

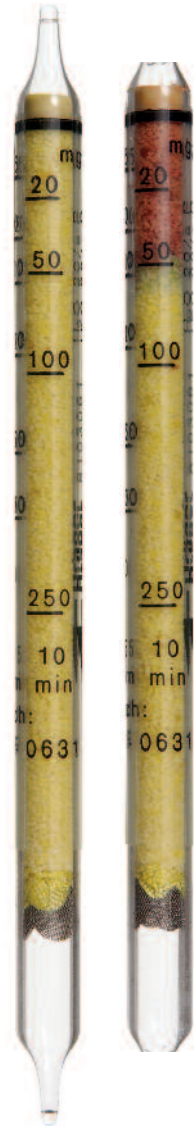

D-13330-2010

5.1.6 Measuring Instructions of Contaminants in Liquids

Acetic Acid 0.5 to 20 g/L

Order No. 67 22 101

Application Range

Determination of acetic acid in water/waste water

Dräger-Tube:	Acetic Acid 5/a
Measuring range:	0.5 to 20 g/L
Number of Strokes (n):	10
Typical Stroke Time:	10 to 30 s
Measurement Time:	approx. 200 s
Sample Volume:	200 mL
Color Change:	blue violet → yellow
Temperature Range:	10 to 30 °C
pH-Measurement:	necessary

Information of Measurement

Using sulfuric acid, the pH-value has to be adjusted to the value of 1.3

System Parameters (valid for pH 1.3)

Measurement Range [g/L]	Standard Deviation [%]	Temperature [°C]	Parameters	
			B	C
0.5 to 20	25	10 to 30	0.339	1.368

Evaluation of Measurement

Calculate acetic acid concentration:

$$Y_{[g/L]} = A \cdot B \cdot (X_{[ppm]} + C)$$

Cross Sensitivity

Formic acid is indicated with lower and propionic acid with higher sensitivity.

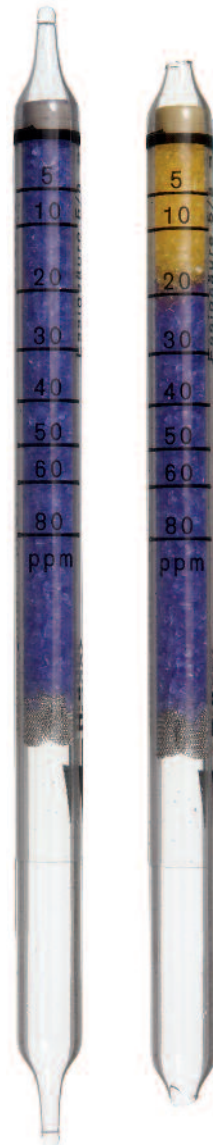

Ammonia 1.5 to 10 mg/L

Order No. 81 01 711

Application Range

Determination of ammonia in water/waste water

Dräger-Tube:	Ammonia 0,25/a
Measuring range:	1.5 to 10 mg/L
Number of Strokes (n):	10
Typical Stroke Time:	10 to 30 s
Measurement Time:	approx. 200 s
Sample Volume:	200 mL
Color Change:	yellow → blue
Temperature Range:	4 to 30 °C
pH-Measurement:	necessary

Information of Measurement

Using acetic acid or sodium hydroxide solution, the pH-value has to be adjusted to the value of 10.2 - 10.3.

System Parameters (valid for pH 1.3)

Measurement Range [mg/L]	Standard Deviation [%]	Temperature [°C]	Parameters	
			B	C
1.5 to 10	30	4 to 7	3.427	2.926
		8 to 12	2.578	1.895
		13 to 17	1.397	1.409
		18 to 24	0.815	0.918
		25 to 30	0.989	0.774

Evaluation of Measurement

Calculate ammonia concentration:

$$Y_{[\text{mg/L}]} = A \cdot B \cdot (X_{[\text{ppm}]} + C)$$

Cross Sensitivity

Other basic substances are also indicated.

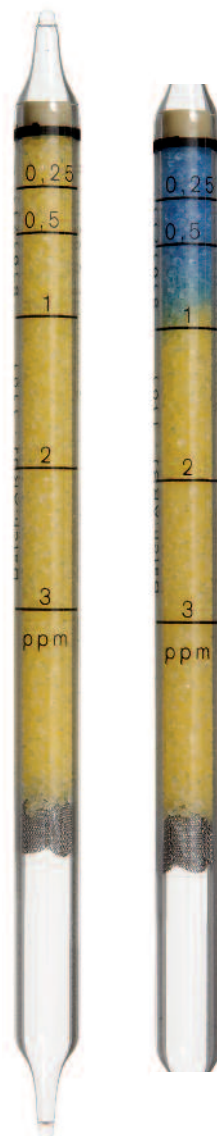

D-13325-2010

A

Ammonia 10 to 100 mg/L

Order No. 81 01 711

Application Range

Determination of ammonia in water/waste water

Dräger-Tube:	Ammonia 0.25/a
Measuring range:	10 to 100 mg/L
Number of Strokes (n):	1
Typical Stroke Time:	10 to 30 s
Measurement Time:	approx. 20 s
Sample Volume:	200 mL
Color Change:	yellow → blue
Temperature Range:	4 to 30 °C
pH-Measurement:	necessary

Information of Measurement

Using acetic acid or sodium hydroxide solution, the pH-value has to be adjusted to the value of 10.2 - 10.3.

System Parameters (valid for pH 10.2 - 10.3)

Measurement Range [mg/L]	Standard Deviation [%]	Temperature [°C]	Parameters	
			B	C
10 to 100	30	4 to 7	61.34	0.826
		8 to 12	40.46	0.310
		13 to 17	29.37	0.943
		18 to 24	27.59	0.463
		25 to 30	18.11	-0.123

Evaluation of Measurement

Calculate ammonia concentration:

$$Y_{[\text{mg/L}]} = A \cdot B \cdot (X_{[\text{ppm}]} + C)$$

Cross Sensitivity

Other basic substances are also indicated.

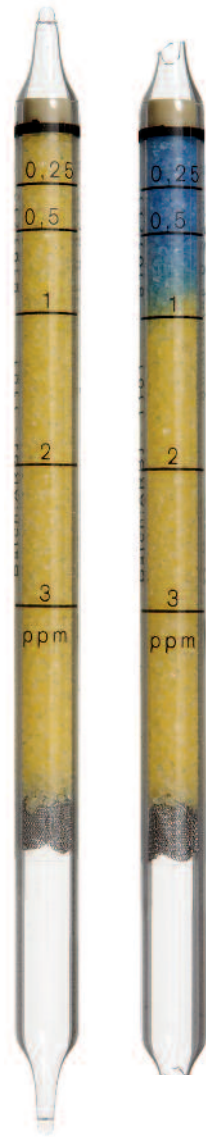

D-13323-2010

Benzene 0.5 to 5 mg/L

Order No. 81 01 231

Application Range

Determination of benzene in water/waste water

Dräger-Tube:	Benzene 2/a
Measuring range:	0.5 to 5 mg/L
Number of Strokes (n):	5
Typical Stroke Time:	40 to 60 s
Measurement Time:	approx. 250 s
Sample Volume:	200 mL
Color Change:	white → brown grey
Temperature Range:	5 to 30 °C
pH-Measurement:	not necessary

System Parameters

Measurement Range [mg/L]	Standard Deviation [%]	Temperature [°C]	Parameters	
			B	C
0.5 to 5	30	5 to 30	0.119	0

Evaluation of Measurement

Calculate benzene concentration:

$$Y_{[\text{mg/L}]} = A \cdot B \cdot (X_{[\text{ppm}]} + C)$$

Cross Sensitivity

Ethyl acetate, perchloroethylene, phenol, styrene, toluene and m-xylene are not indicated.

Petroleum hydrocarbons are indicated with lower sensitivity.



ST-184-2001

A

Benzene 0.2 to 5 mg/L

Order No. 81 01 661

Application Range

Determination of acetic acid in water/waste water

Dräger-Tube:	Toluene 5/b
Measuring range:	0.2 to 5 mg/L
Number of Strokes (n):	6
Typical Stroke Time:	60 to 90 s
Measurement Time:	approx. 450 s
Sample Volume:	200 mL
Color Change:	white → yellow green
Temperature Range:	5 to 30 °C
pH-Measurement:	not necessary

System Parameters

Measurement Range [mg/L]	Standard Deviation [%]	Temperature [°C]	Parameters	
			B	C
0.2 to 5	40	5 to 30	0.057	0

Evaluation of Measurement

Calculate benzene concentration:

$$Y_{[\text{mg/L}]} = A \cdot B \cdot (X_{[\text{ppm}]} + C)$$

Cross Sensitivity

Toluene, xylene (all isomere), ethylbenzene and styrene are indicated with different sensitivity.

Acetone, ethanol and n-octane do not interfere with the reading.

Phenol does not interfere with the reading up to a concentration of 100 mg/L

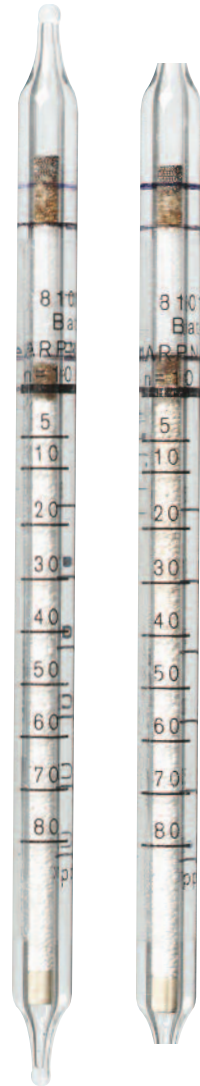

ST-151-2001

BTX-Aromatics 0.2 to 5 mg/L

Order No. 81 01 661

Application Range

Determination of sum parameter benzene, toluene and xylene in water/waste water

Dräger-Tube:	Toluene 5/b
Measuring range:	0.2 to 5 mg/L
Number of Strokes (n):	6
Typical Stroke Time:	60 to 90 s
Measurement Time:	approx. 450 s
Sample Volume:	200 mL
Color Change:	white → brown violet to yellow
Temperature Range:	5 to 30 °C
pH-Measurement:	not necessary

System Parameters

Measurement Range [mg/L]	Standard Deviation [%]	Temperature [°C]	Parameters	
			B	C
0.2 to 5	40	5 to 30	0.057	0

Evaluation of Measurement

Calculate BTX concentration:

$$Y_{[\text{mg/L}]} = A \cdot B \cdot (X_{[\text{ppm}]} + C)$$

Cross Sensitivity

Ethylbenzene and styrene are also indicated, however, with different sensitivities.

Acetone, ethanol and n-octane are not indicated. Phenol does not interfere with the reading up to a concentration of 100 mg/L.

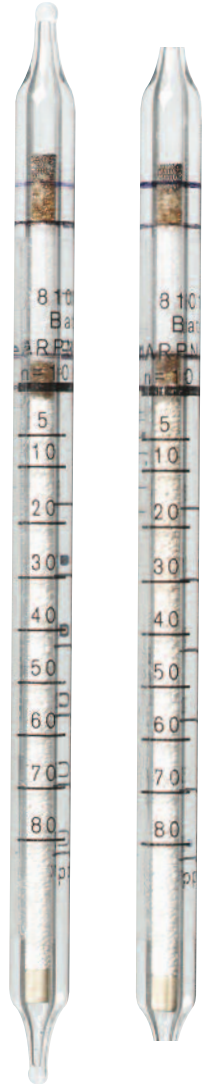

ST-151-2001

BTX-Aromatics qualitative in oil

Order No. 81 01 661

Application Range

Determination of sum parameter benzene, toluene and xylene in oil sludges/oil emulsions

Dräger-Tube:	Toluene 5/b
Measuring range:	qualitative
Number of Strokes (n):	maximum 10
Typical Stroke Time:	60 to 80 s
Measurement Time:	approx. 75 to 740 s
Sample Volume:	approx. 0.5 g
Color Change:	white → brown violet to yellow-green
Temperature Range:	5 to 25 °C
pH-Measurement:	not necessary

Information of Measurement

- Approx. 0.5 g oil sample has to be shaken intensively with 1 L de-ionized water for 2 minutes in a laboratory bottle.
- The solution must be filtered through an analysis funnel with a round filter (black ribbon) directly into the gas wash bottle up to the 200 mL mark.

Evaluation of Measurement

The measurement evaluation is qualitative (yes or no)

Cross Sensitivity

Benzene, xylene (all isomere), ethylbenzene and toluene are indicated.

Acetone, ethanol, phenol and n-octane are not indicated.

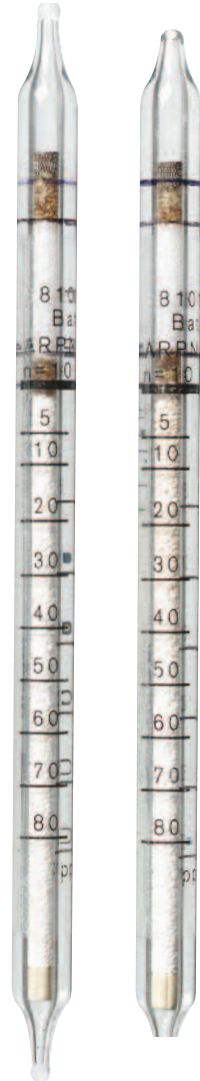

ST-154-2001

Application Range

Determination of sum parameter benzene, toluene and xylene in soil

Dräger-Tube:	Toluene 5/b
Measuring range:	2 to 50 mg/kg dry substance
Number of Strokes (n):	6
Typical Stroke Time:	60 to 90 s
Measurement Time:	approx. 450 s
Sample Volume:	20 g soil
Color Change:	white → brown violet to yellow green
Temperature Range:	15 to 25 °C
pH-Measurement:	not necessary

Information of Measurement

- 20 g soil is suspended completely with 100 mL de-ionized water and 1 mL surfactant solutions (2 mass % Extran AP 13, Merck).
- The precipitate must rest for approx. 1 minute, until the particles have settled to the bottom; the liquid above the particles has to be filled into the wash bottle
- The remaining precipitate has to be shaken two times with 50 mL de-ionized water and the liquid above the particles has to be filled into the wash bottle
- The gas wash bottle is filled up with de-ionized water up to 200 mL mark.

System Parameters

Measurement Range [mg/kg]	Standard Deviation [%]	Temperature [°C]	Parameters	
			B	C
2 to 50	50	15 to 25	0.456	0

Evaluation of Measurement

Calculate BTX concentration:

$$Y_{\text{soil}[\text{mg/L}]} = A \cdot B \cdot (X_{[\text{ppm}]} + C)$$

Cross Sensitivity

Ethylbenzene and styrene are indicated with different sensitivity. Acetone, ethanol and n-octane do not interfere with the reading. Phenol does not interfere with the reading up to a concentration of 100 mg/L

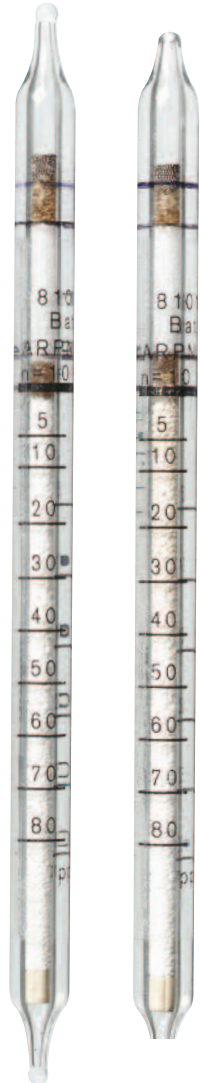

ST-1151-2001

Chlorinated Hydrocarbons qualitative in oil

Order No. 81 01 551

Application Range

Determination of volatile chlorinated hydrocarbons
in oil sludges/oil emulsions

Dräger-Tube:	Perchloroethylene 0.1/a
Measuring range:	qualitative
Number of Strokes (n):	maximum 10
Typical Stroke Time:	2 to 3 minutes
Measurement Time:	approx. 2 to 20 minutes
Sample Volume:	approx. 0.5 g
Color Change:	yellow white → grey blue
Temperature Range:	10 to 25 °C
pH-Measurement:	not necessary

Information of Measurement

- Approx. 0.5 g oil sample has to be shaken intensively with 1 L de-ionized water for 2 minutes in a laboratory bottle.
- The solution must be filtered through an analysis funnel with a round filter (black ribbon) directly into the gas wash bottle up to the 200 mL mark.

Evaluation of Measurement

The measurement evaluation is qualitative (yes or no)

Cross Sensitivity

Chlorobenzene, 1,1-dichloroethane, 1,2-dichloroethane, dichloromethane, perchloroethylene, trichloroethylene and trichloromethane are indicated. Carbon tetrachloride and 1,1,1-trichloroethane are not indicated.



Chlorinated Hydrocarbons qualitative in multiple phase

Order No. 81 01 551

Application Range

Determination of volatile chlorinated hydrocarbons in multiple phase

Dräger-Tube:	Perchloroethylene 0.1/a
Measuring range:	qualitative
Number of Strokes (n):	maximum 10
Typical Stroke Time:	2 to 3 minutes
Measurement Time:	approx. 2 to 20 minutes
Sample Volume:	200 mL
Color Change:	yellow white → grey blue
Temperature Range:	10 to 25 °C
pH-Measurement:	not necessary

Information of Measurement

- Mix a multiple phase sample which consists of e.g. 250 g water, 10 g fixed phase and 10 g oil part (about 300 mL) is mixed with approx. 5 g activated coal. It must rest for 3 minutes and then be shaken for 1 min.
- 0.2 g hydrophobated peat is added and the it must be shaken for 1 minute.
- The liquid is filled into the gas wash bottle up to the 200 mL mark.

Evaluation of Measurement

The measurement evaluation is qualitative (yes or no)

Cross Sensitivity

Chlorobenzene, 1,1-dichloroethane, 1,2-dichloroethane, dichloromethane, perchloroethylene, trichloroethylene and trichloromethane are indicated. Carbon tetrachloride and 1,1,1-trichloroethane are not indicated.



ST-57/51-2004

Chlorinated Hydrocarbons qualitative in soil

Order No. 81 01 551

Application Range

Determination of volatile chlorinated hydrocarbons in soil

Dräger-Tube:	Perchloroethylene 0.1/a
Measuring range:	qualitative
Number of Strokes (n):	maximum 10
Typical Stroke Time:	2 to 3 minutes
Measurement Time:	approx. 2 to 20 minutes
Sample Volume:	20 g
Color Change:	yellow white → grey blue
Temperature Range:	10 to 25 °C
pH-Measurement:	not necessary

Information of Measurement

- 20 g soil is suspended completely with 100 mL de-ionized water and 1 mL surfactant solutions (2 mass % Extran AP 13, Merck).
- The precipitate must rest for approx. 1 minute, until the particles have settled to the bottom; the liquid above the particles has to be filled into the wash bottle
- The remaining precipitate has to be shaken two times with 50 mL de-ionized water and the liquid above the particles has to be filled into the wash bottle
- The gas wash bottle is filled up with de-ionized water up to 200 mL mark.

Evaluation of Measurement

The measurement evaluation is qualitative (yes or no)

Cross Sensitivity

Chlorobenzene, 1,1-dichloroethane, 1,2-dichloroethane, dichloromethane, perchloroethylene, trichloroethylene and trichloromethane are indicated. Carbon tetrachloride and 1,1,1-trichloroethane are not indicated.



ST-5751-2004

Chlorinated Hydrocarbons qualitative in multiple phase

Order No. 81 01 501

Application Range

Determination of volatile chlorinated hydrocarbons in multiple phase

Dräger-Tube:	Perchloroethylene 2/a
Measuring range:	qualitative
Number of Strokes (n):	maximum 10
Typical Stroke Time:	45 to 65 s
Measurement Time:	approx. 55 to 550 s
Sample Volume:	200 mL
Color Change:	yellow white → grey blue
Temperature Range:	10 to 25 °C
pH-Measurement:	not necessary

Information of Measurement

- Mix a multiple phase sample which consists of e.g. 250 g water, 10 g fixed phase and 10 g oil part (about 300 mL) is mixed with approx. 5 g activated coal. It must rest for 3 minutes and then be shaken for 1 min.
- 0.2 g hydrophobated peat is added and the it must be shaken for 1 minute.
- The liquid is filled into the gas wash bottle up to the 200 mL mark.

Evaluation of Measurement

The measurement evaluation is qualitative (yes or no)

Cross Sensitivity

Chlorobenzene, 1,1-dichloroethane, 1,2-dichloroethane, dichloromethane, perchloroethylene, trichloroethylene and trichloromethane are indicated. Carbon tetrachloride and 1,1,1-trichloroethane are not indicated.



Chlorinated Hydrocarbons qualitative in oil

Order No. 81 01 501

Application Range

Determination of volatile chlorinated hydrocarbons
in oil sludges/oil emulsions

Dräger-Tube:	Perchloroethylene 2/a
Measuring range:	qualitative
Number of Strokes (n):	maximum 10
Typical Stroke Time:	45 to 65 s
Measurement Time:	approx. 55 to 550 s
Sample Volume:	approx. 0.5 g
Color Change:	yellow white → grey blue
Temperature Range:	10 to 25 °C
pH-Measurement:	not necessary

Information of Measurement

- Approx. 0.5 g oil sample has to be shaken intensively with 1 L de-ionized water for 2 minutes in a laboratory bottle.
- The solution must be filtered through an analysis funnel with a round filter (black ribbon) directly into the gas wash bottle up to the 200 mL mark.

Evaluation of Measurement

The measurement evaluation is qualitative (yes or no)

Cross Sensitivity

Chlorobenzene, 1,1-dichloroethane, 1,2-dichloroethane, dichloro-methane, perchloroethylene, trichloroethylene and trichloromethane are indicated. Carbon tetrachloride and 1,1,1-trichloroethane are not indicated.



ST 90-2001

Chlorinated Hydrocarbons qualitative in multiple phase

Order No. 81 01 501

Application Range

Determination of volatile chlorinated hydrocarbons in multiple phase

Dräger-Tube:	Perchloroethylene 2/a
Measuring range:	qualitative
Number of Strokes (n):	maximum 10
Typical Stroke Time:	45 to 65 s
Measurement Time:	approx. 55 to 550 s
Sample Volume:	200 mL
Color Change:	yellow white → grey blue
Temperature Range:	10 to 25 °C
pH-Measurement:	not necessary

Information of Measurement

- Mix a multiple phase sample which consists of e.g. 250 g water, 10 g fixed phase and 10 g oil part (about 300 mL) is mixed with approx. 5 g activated coal. It must rest for 3 minutes and then be shaken for 1 min.
- 0.2 g hydrophobated peat is added and the it must be shaken for 1 minute.
- The liquid is filled into the gas wash bottle up to the 200 mL mark.

Evaluation of Measurement

The measurement evaluation is qualitative (yes or no)

Cross Sensitivity

Chlorobenzene, 1,1-dichloroethane, 1,2-dichloroethane, dichloromethane, perchloroethylene, trichloroethylene and trichloromethane are indicated. Carbon tetrachloride and 1,1,1-trichloroethane are not indicated.



ST-90-2001

Chlorinated Hydrocarbons qualitative in oil

Order No. CH 21 101

Application Range

Determination of volatile chlorinated hydrocarbons
in oil sludges/oil emulsions

Dräger-Tube:	Trichloroethane 50/a
Measuring range:	qualitative
Number of Strokes (n):	6 + 3 desorption strokes in clean air
Typical Stroke Time:	40 to 70 s + 30 s
Measurement Time:	approx. 660 s + 90 s
Sample Volume:	approx. 0.5 g
Color Change:	grey → brown red
Temperature Range:	10 to 25 °C
pH-Measurement:	not necessary

Information of Measurement

- Approx. 0.5 g oil sample has to be shaken intensively with 1 L de-ionized water for 2 minutes in a laboratory bottle.
- The solution must be filtered through an analysis funnel with a round filter (black ribbon) directly into the gas wash bottle up to the 200 mL mark.

Evaluation of Measurement

The measurement evaluation is qualitative (yes or no)

Cross Sensitivity

Dichloromethane, Perchloroethylene, Carbon tetrachloride, 1,1,1-Trichloroethane and Trichloroethylene are indicated. Petroleum hydrocarbons are not indicated.



D-13346-2010

Chlorinated Hydrocarbons qualitative in multiple phase

Order No. CH 21 101

Application Range

Determination of volatile chlorinated hydrocarbons in multiple phase

Dräger-Tube:	Trichloroethane 50/a
Measuring range:	qualitative
Number of Strokes (n):	6 + 3 desorption strokes in clean air
Typical Stroke Time:	40 to 70 s + 30 s
Measurement Time:	approx. 660 s + 90 s
Sample Volume:	200 mL
Color Change:	grey → brown red
Temperature Range:	10 to 25 °C
pH-Measurement:	not necessary

Information of Measurement

- Mix a multiple phase sample which consists of e.g. 250 g water, 10 g fixed phase and 10 g oil part (about 300 mL) is mixed with approx. 5 g activated coal. It must rest for 3 minutes and then be shaken for 1 min.
- 0.2 g hydrophobated peat is added and the it must be shaken for 1 minute.
- The liquid is filled into the gas wash bottle up to the 200 mL mark.

Evaluation of Measurement

The measurement evaluation is qualitative (yes or no)

Cross Sensitivity

Dichloromethane, perchloroethylene, carbon tetrachloride, 1,1,1-trichloroethane and trichloroethylene are indicated. Petroleum hydrocarbons are not indicated.



D-13346-2010

Chlorinated Hydrocarbons qualitative in oil

Order No. 81 01 671

Application Range

Determination of volatile chlorinated hydrocarbons
in oil sludges/oil emulsions

Dräger-Tube:	Methylbromide 0.5/a
Measuring range:	qualitative
Number of Strokes (n):	maximum 10
Typical Stroke Time:	60 to 70 s
Measurement Time:	approx. 65 to 650 s
Sample Volume:	approx. 0.5 g
Color Change:	white grey → blue green
Temperature Range:	10 to 25 °C
pH-Measurement:	not necessary

Information of Measurement

- Approx. 0.5 g oil sample has to be shaken intensively with 1 L de-ionized water for 2 minutes in a laboratory bottle.
- The solution must be filtered through an analysis funnel with a round filter (black ribbon) directly into the gas wash bottle up to the 200 mL mark.

Evaluation of Measurement

The measurement evaluation is qualitative (yes or no)

Cross Sensitivity

Chloroform, 1,1-dichloroethane, 1,2-dichloroethane, dichloromethane, methylbromide, perchlorethylene, 1,1,1-trichloroethane and trichloroethylene are indicated. 1,4-dichlorobutane and carbon tetrachloride is not indicated.



Chlorinated Hydrocarbons qualitative in multiple phase

Order No. 81 01 671

Application Range

Determination of volatile chlorinated hydrocarbons in multiple phase

Dräger-Tube:	Methylbromide 0.5/a
Measuring range:	qualitative
Number of Strokes (n):	maximum 10
Typical Stroke Time:	60 to 70 s
Measurement Time:	approx. 65 to 650 s
Sample Volume:	200 mL
Color Change:	white grey → blue green
Temperature Range:	10 to 25 °C
pH-Measurement:	not necessary

Information of Measurement

- Mix a multiple phase sample which consists of e.g. 250 g water, 10 g fixed phase and 10 g oil part (about 300 mL) is mixed with approx. 5 g activated coal. It must rest for 3 minutes and then be shaken for 1 min.
- 0.2 g hydrophobated peat is added and the it must be shaken for 1 minute.
- The liquid is filled into the gas wash bottle up to the 200 mL mark.

Evaluation of Measurement

The measurement evaluation is qualitative (yes or no)

Cross Sensitivity

Chloroform, 1,1-dichloroethane, 1,2-dichloroethane, dichloromethane, methylbromide, perchlorethylene, 1,1,1-trichloroethane and trichloroethylene are indicated. 1,4-dichlorobutane and carbon tetrachloride is not indicated.



D-5449-2014

Diesel Fuels 0.5 to 5 mg/L

Order No. 81 01 691

Application Range

Determination of diesel fuels in water/waste water

Dräger-Tube:	Petroleum hydrocarbons 10/a
Measuring range:	0.5 to 5 mg/L
Number of Strokes (n):	8
Typical Stroke Time:	30 to 60 s
Measurement Time:	approx. 360 s
Sample Volume:	200 mL
Color Change:	white → brown green
Temperature Range:	5 to 25 °C
pH-Measurement:	not necessary

System Parameters

Measurement Range [mg/L]	Standard Deviation [%]	Temperature [°C]	Parameters	
			B	C
0.5 to 5	30	5 to 25	0.089	0

Readings > 50 ppm give qualitative results, only.

Evaluation of Measurement

Calculate diesel fuel concentration:

$$Y_{[\text{mg/L}]} = A \cdot B \cdot (X_{[\text{ppm}]} + C)$$

Cross Sensitivity

Ethyl acetate, diesel oil, hydrogen sulfide and toluene are indicated with lower sensitivity.

Perchloroethylene is indicated with higher sensitivity.



Diesel Fuels qualitative in soil

Order No. 81 01 691

Application Range

Determination of diesel fuels in soil

Dräger-Tube:	Petroleum Hydrocarbons 10/a
Measuring range:	qualitative
Number of Strokes (n):	maximum 10
Typical Stroke Time:	30 to 60 s
Measurement Time:	approx. 45 to 450 s
Sample Volume:	20 g
Color Change:	white → brown green
Temperature Range:	5 to 25 °C
pH-Measurement:	not necessary

Information of Measurement

- 20 g soil is suspended completely with 100 mL de-ionized water.
- The precipitate must rest for approx. 1 minute, until the particles have settled to the bottom; the liquid above the particles has to be filled into the was bottle
- The remaining precipitate has to be shaken two times with 50 mL de-ionized water and the liquid above the particles has to be filled into the was bottle
- The gas wash bottle is filled up with de-ionized water up to 200 mL mark.

Evaluation of Measurement

The measurement evaluation is qualitative (yes or no)

Cross Sensitivity

Diesel oil, ethyl acetate, perchloroethylene, hydrogen sulfide and toluene are also indicated.

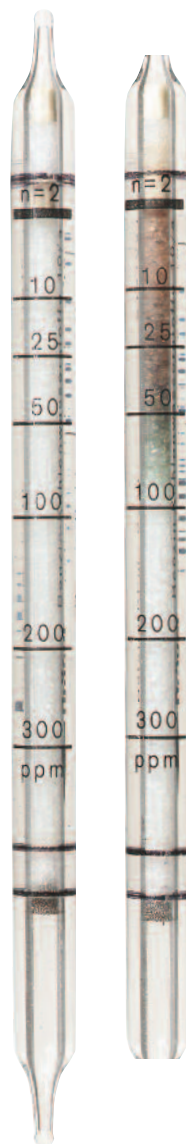

ST-19-2001

Ethylbenzene 0.2 to 5 mg/L

Order No. 81 01 661

Application Range

Determination of ethylbenzene in water/waste water

Dräger-Tube:	Toluene 5/b
Measuring range:	0.2 to 5 mg/L
Number of Strokes (n):	6
Typical Stroke Time:	60 to 90 s
Measurement Time:	approx. 450 s
Sample Volume:	200 mL
Color Change:	white → yellow green
Temperature Range:	5 to 30 °C
pH-Measurement:	not necessary

System Parameters

Measurement Range [mg/L]	Standard Deviation [%]	Temperature [°C]	Parameters	
			B	C
0.2 to 5	40	5 to 30	0.057	0

Evaluation of Measurement

Calculate ethylbenzene concentration:

$$Y_{[\text{mg/L}]} = A \cdot B \cdot (X_{[\text{ppm}]} + C)$$

Cross Sensitivity

Benzene, toluene, xylene (all isomere) and styrene are indicated with different sensitivity.

Acetone, ethanol and n-octane do not interfere with the reading. Phenol does not interfere with the reading up to a concentration of 100 mg/L

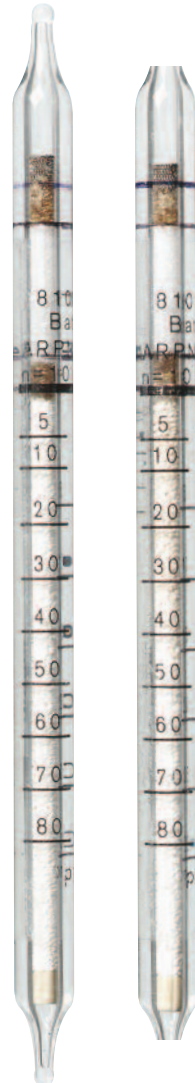

ST-161-2001

Formic Acid 1 to 20 g/L

Order No. 67 22 101

Application Range

Determination of formic acid in water/waste water

Dräger-Tube:	Acetic Acid 5/a
Measuring range:	1 to 20 g/L
Number of Strokes (n):	10
Typical Stroke Time:	10 to 30 s
Measurement Time:	approx. 200 s
Sample Volume:	200 mL
Color Change:	blue violet → yellow
Temperature Range:	5 to 25 °C
pH-Measurement:	necessary

Information of Measurement

Using sulfuric acid, the pH-value has to be adjusted to the value of 1.3.

System Parameters (valid for pH 1.3)

Measurement Range [g/L]	Standard Deviation [%]	Temperature [°C]	Parameters	
			B	C
1 to 20	25	5 to 25	0.487	1.607

Evaluation of Measurement

Calculate formic acid concentration:

$$Y_{[g/L]} = A \cdot B \cdot (X_{[ppm]} + C)$$

Cross Sensitivity

Acetic acid and propionic acid are indicated with higher sensitivity.

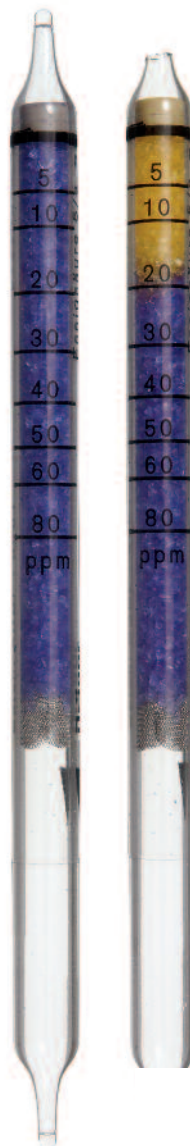

D-183005-2010

Gasoline qualitative in soil

Order No. 81 01 691

Application Range

Determination of gasoline in soil

Dräger-Tube:	Petroleum Hydrocarbons 10/a
Measuring range:	qualitative
Number of Strokes (n):	maximum 10
Typical Stroke Time:	30 to 60 s
Measurement Time:	approx. 45 to 450 s
Sample Volume:	20 g
Color Change:	white → brown green
Temperature Range:	5 to 25 °C
pH-Measurement:	not necessary

Information of Measurement

- 20 g soil is suspended completely with 100 mL de-ionized water.
- The precipitate must rest for approx. 1 minute, until the particles have settled to the bottom; the liquid above the particles has to be filled into the was bottle
- The remaining precipitate has to be shaken two times with 50 mL de-ionized water and the liquid above the particles has to be filled into the was bottle
- The gas wash bottle is filled up with de-ionized water up to 200 mL mark.

Evaluation of Measurement

The measurement evaluation is qualitative (yes or no)

Cross Sensitivity

Diesel oil, ethyl acetate, perchloroethylene, hydrogen sulfide and toluene are also indicated.

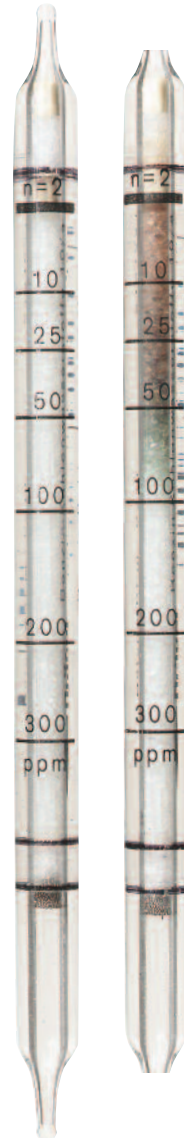

Gasoline 0.1 to 2 mg/L

Order No. 81 01 691

Application Range

Determination of gasoline in water/waste water

Dräger-Tube:	Petroleum Hydrocarbons 10/a
Measuring range:	0.1 to 2 mg/L for n-octan
Number of Strokes (n):	2
Typical Stroke Time:	30 to 60 s
Measurement Time:	approx. 90 s
Sample Volume:	200 mL
Color Change:	white → brow green
Temperature Range:	5 to 25 °C
pH-Measurement:	not necessary

System Parameters

Measurement Range [mg/L]	Standard Deviation [%]	Temperature [°C]	Parameters	
			B	C
0.1 to 2	30	5 to 25	0.010	0

Evaluation of Measurement

Calculate gasoline concentration:

$$Y_{[\text{mg/L}]} = A \cdot B \cdot (X_{[\text{ppm}]} + C)$$

Cross Sensitivity

Ethyl acetate, diesel oil, hydrogen sulfide and toluene are indicated with lower sensitivity. Perchloroethylene is indicated with higher sensitivity.

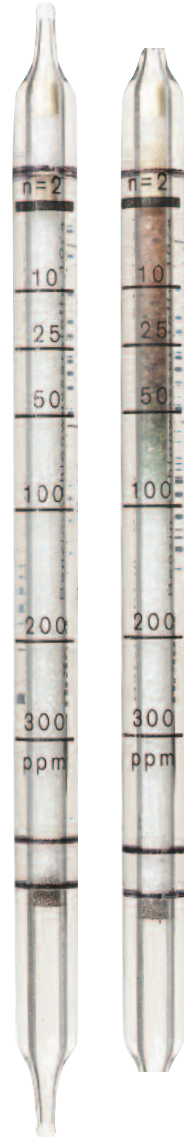

ST-16-2001

Hydrogen Sulfide 50 to 500 µg/L

Order No. 81 01 461

Application Range

Determination of hydrogen sulfide (sum of sulfide) in water/waste water

Dräger-Tube:	Hydrogen Sulfide 0.2/a
Measuring range:	50 to 500 mg/L
Number of Strokes (n):	5
Typical Stroke Time:	50 to 80 s
Measurement Time:	approx. 325 s
Sample Volume:	200 mL
Color Change:	white → pale brown
Temperature Range:	3 to 30 °C
pH-Measurement:	necessary

Information of Measurement

Using acetic acid or sodium hydroxide solution, the pH-value has to be adjusted to the value of 7.3 - 7.4 (K=1)

System Parameters (valid for pH 7.3 - 7.4)

Measurement Range [µg/L]	Standard Deviation [%]	Temperature [°C]	Parameters	
			B	C
50 to 500	30	3 to 7	72	0.2
		8 to 13	63	0.2
		14 to 30	57	0.2

Evaluation of Measurement

Calculate hydrogen sulfide concentration:

$$Y_{[\mu\text{g/L}]} = A \cdot B \cdot (K \cdot X_{[\text{ppm}]} + C)$$

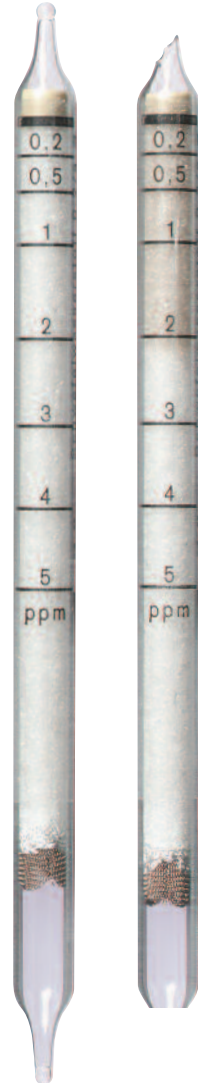

Hydrogen Sulfide 0.2 to 1 mg/L

Order No. 67 19 001

Application Range

Determination of hydrogen sulfide (sum of sulfide) in water/waste water

Dräger-Tube:	Hydrogen Sulfide 1/c
Measuring range:	0.2 to 1 mg/L
Number of Strokes (n):	5
Typical Stroke Time:	50 to 100 s
Measurement Time:	approx. 375 s
Sample Volume:	200 mL
Color Change:	white → pale brown
Temperature Range:	3 to 30 °C
pH-Measurement:	necessary

Information of Measurement

Using acetic acid or sodium hydroxide solution, the pH-value has to be adjusted to the value of 7.3 - 7.4 (K=1).

System Parameters (valid for pH 7.3 - 7.4)

Measurement Range [mg/L]	Standard Deviation [%]	Temperature [°C]	Parameters	
			B	C
0.2 to 1	30	3 to 7	0.051	0
		8 to 13	0.045	0
		14 to 30	0.040	0

Evaluation of Measurement

Calculate hydrogen sulfide concentration:

$$Y_{[\text{mg/L}]} = A \cdot B \cdot (K \cdot X_{[\text{ppm}]} + C)$$



ST-190-2001

Hydrogen Sulfide 0.5 to 10 mg/L

Order No. CH 29 801

Application Range

Determination of hydrogen sulfide (sum of sulfide) in water/waste water

Dräger-Tube:	Hydrogen Sulfide 5/b
Measuring range:	0.5 to 10 g/L
Number of Strokes (n):	2
Typical Stroke Time:	50 to 80 s
Measurement Time:	approx. 130 s
Sample Volume:	200 mL
Color Change:	white → brown
Temperature Range:	3 to 30 °C
pH-Measurement:	necessary

Information of Measurement

Using acetic acid or sodium hydroxide solution, the pH-value has to be adjusted to the value of 7.3 - 7.4 (K=1).

System Parameters (valid for pH 7.3 - 7.4)

Measurement Range [mg/L]	Standard Deviation [%]	Temperature [°C]	Parameters	
			B	C
0.5 to 10	30	3 to 7	0.131	0
		8 to 13	0.122	0
		14 to 30	0.127	0

Evaluation of Measurement

Calculate hydrogen sulfide concentration:

$$Y_{[\text{mg/L}]} = A \cdot B \cdot (K \cdot X_{[\text{ppm}]} + C)$$

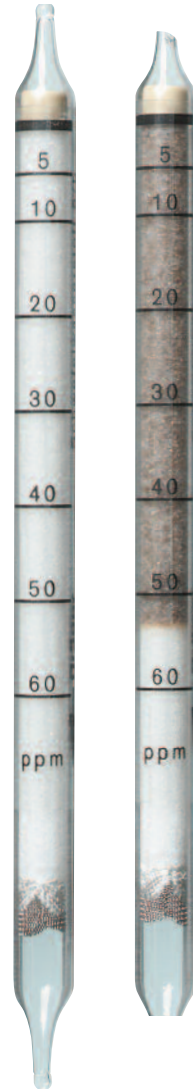

ST-125-2001

Jet Fuels (Kerosene) 0.5 to 5 mg/L

Order No. 81 01 691

Application Range

Determination of jet fuels in water/waste water

Dräger-Tube: Petroleum hydrocarbons 10/a

Measuring range: 0.5 to 5 mg/L

Number of Strokes (n): 4

Typical Stroke Time: 30 to 60 s

Measurement Time: approx. 180 s

Sample Volume: 200 mL

Color Change: white → brown green

Temperature Range: 5 to 25 °C

pH-Measurement: not necessary

System Parameters

Measurement Range [mg/L]	Standard Deviation [%]	Temperature [°C]	Parameters	
			B	C
0.5 to 5	25	5 to 25	0.062	0

Evaluation of Measurement

Calculate jet fuel concentration:

$$Y_{[\text{mg/L}]} = A \cdot B \cdot (X_{[\text{ppm}]} + C)$$

Cross Sensitivity

Ethyl acetate, diesel oil, hydrogen sulfide and toluene are indicated with lower sensitivity. Perchloroethylene is indicated with higher sensitivity.



ST-19-2001

Jet Fuels (Kerosene) qualitative in soil

Order No. 81 01 691

Application Range

Determination of jet fuels in soil

Dräger-Tube:	Petroleum Hydrocarbons 10/a
Measuring range:	qualitative
Number of Strokes (n):	maximum 10
Typical Stroke Time:	30 to 60 s
Measurement Time:	approx. 45 to 450 s
Sample Volume:	20 g
Color Change:	white → brown green
Temperature Range:	5 to 25 °C
pH-Measurement:	not necessary

Information of Measurement

- 20 g soil is suspended completely with 100 mL de-ionized water.
- The precipitate must rest for approx. 1 minute, until the particles have settled to the bottom; the liquid above the particles has to be filled into the was bottle
- The remaining precipitate has to be shaken two times with 50 mL de-ionized water and the liquid above the particles has to be filled into the was bottle
- The gas wash bottle is filled up with de-ionized water up to 200 mL mark.

Evaluation of Measurement

The measurement evaluation is qualitative (yes or no)

Cross Sensitivity

Diesel oil, ethyl acetate, perchloroethylene, hydrogen sulfide and toluene are also indicated.

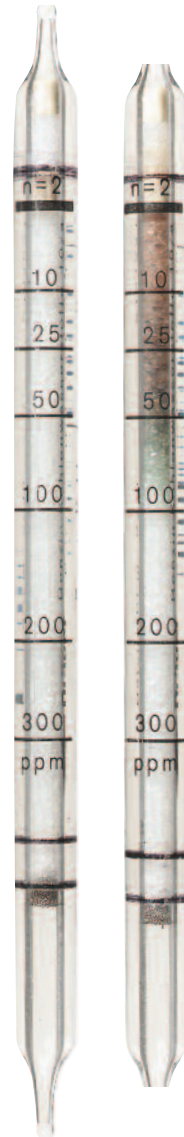

n-Octane 0.1 to 2 mg/L

Order No. 81 01 691

Application Range

Determination of n-octane in water/waste water

Dräger-Tube:	Petroleum Hydrocarbons 10/a
Measuring range:	0.1 to 2 mg/L
Number of Strokes (n):	2
Typical Stroke Time:	30 to 60 s
Measurement Time:	approx. 90 s
Sample Volume:	200 mL
Color Change:	white → brown green
Temperature Range:	5 to 25 °C
pH-Measurement:	not necessary

System Parameters

Measurement Range [mg/L]	Standard Deviation [%]	Temperature [°C]	Parameters	
			B	C
0.1 to 2	30	5 to 25	0.010	0

Evaluation of Measurement

Calculate n-octane concentration:

$$Y_{[\text{mg/L}]} = A \cdot B \cdot (X_{[\text{ppm}]} + C)$$

Cross Sensitivity

Ethyl acetate, diesel oil, hydrogen sulfide and toluene are indicated with lower sensitivity.

Perchloroethylene is indicated with higher sensitivity.

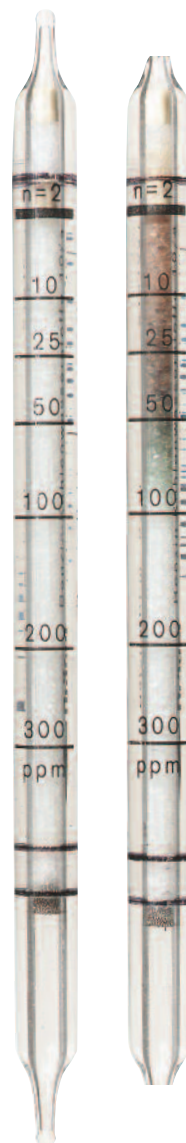

ST-19-2001

n-Octane 2 to 25 mg/L

Order No. 67 30 201

Application Range

Determination of n-octane in water/waste water

Dräger-Tube:	Petroleum Hydrocarbons 100/a
Measuring range:	2 to 25 mg/L
Number of Strokes (n):	2
Typical Stroke Time:	30 to 45 s
Measurement Time:	approx. 75 s
Sample Volume:	200 mL
Color Change:	white → brown green
Temperature Range:	5 to 25 °C
pH-Measurement:	not necessary

System Parameters

Measurement Range [mg/L]	Standard Deviation [%]	Temperature [°C]	Parameters	
			B	C
2 to 25	30	5 to 25	0.010	0

Evaluation of Measurement

Calculate n-octane concentration:

$$Y_{[\text{mg/L}]} = A \cdot B \cdot (X_{[\text{ppm}]} + C)$$

Cross Sensitivity

Ethyl acetate and hydrogen sulfide are indicated with lower sensitivity. Perchloroethylene is indicated with higher sensitivity. Toluene is indicated with different sensitivity



Organic Acids 0.5 to 15 g/L

Order No. 67 22 101

Application Range

Determination of sum parameter acetic acid, formic acid and propionic acid in water/waste water

Dräger-Tube:	Acetic Acid 5/a
Measuring range:	0.3 to 15 g/L
Number of Strokes (n):	10
Typical Stroke Time:	10 to 30 s
Measurement Time:	approx. 200 s
Sample Volume:	200 mL
Color Change:	blue violet → yellow
Temperature Range:	10 to 25 °C
pH-Measurement:	necessary

Information of Measurement

Using sulfuric acid, the pH-value has to be adjusted to the value of 1.3.

System Parameters (valid for pH 1.3)

Measurement Range [g/L]	Standard Deviation [%]	Temperature [°C]	Parameters	
			B	C
0.5 to 15	25	10 to 25	0.241	1.157

Evaluation of Measurement

Calculate acid concentration:

$$Y_{[g/L]} = A \cdot B \cdot (X_{[ppm]} + C)$$

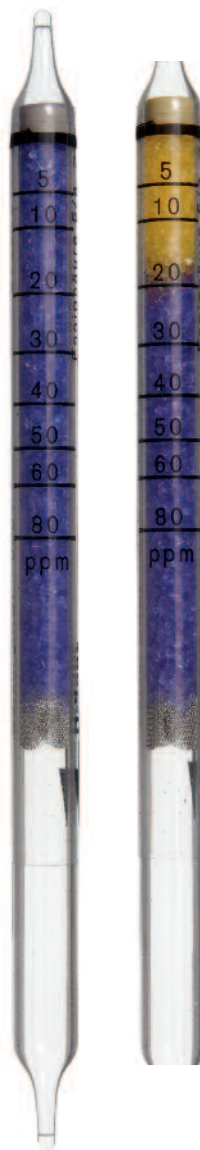

D-19305-2010

Perchloroethylene 10 to 80 µg/L

Order No. 81 01 551

Application Range

Determination of perchloroethylene in water/waste water

Dräger-Tube:	Perchloroethylene 0.1/a
Measuring range:	10 to 80 µg/L
Number of Strokes (n):	8
Typical Stroke Time:	2 to 3 minutes
Measurement Time:	approx. 20 minutes
Sample Volume:	200 mL
Color Change:	yellow white → grey blue
Temperature Range:	5 to 30 °C
pH-Measurement:	not necessary

System Parameters

Measurement Range [µg/L]	Standard Deviation [%]	Temperature [°C]	Parameters	
			B	C
10 to 80	30	5 to 30	70	-0.1

Evaluation of Measurement

Calculate perchloroethylene concentration:

$$Y_{[\mu\text{g/L}]} = A \cdot B \cdot (X_{[\text{ppm}]} + C)$$

Cross Sensitivity

Dichloromethane, chlorobenzene, chloroform, 1,1-dichloroethane and 1,2-dichloroethane are indicated with lower sensitivity. Trichloroethylene is indicated with nearly the same sensitivity. Petroleum hydrocarbons, benzene, carbon tetrachloride, toluene, 1,1,1-trichloroethane and xylene are not indicated.



ST-193-2001

Perchloroethylene 0.1 to 2 mg/L

Order No. 81 01 501

Application Range

Determination of perchloroethylene in water/waste water

Dräger-Tube:	Perchloroethylene 2/a
Measuring range:	0.1 to 1 mg/L / 0.5 to 2 mg/L
Number of Strokes (n):	8 / 4
Typical Stroke Time:	45 to 65 s
Measurement Time:	approx. 440 s / ca. 220 s
Sample Volume:	200 mL
Color Change:	yellow white → grey blue
Temperature Range:	8 to 37 °C
pH-Measurement:	not necessary

System Parameters

Measurement Range [mg/L]	Standard Deviation [%]	Temperature [°C]	Parameters	
			B	C
0.1 to 1 number of strokes n=8	25	8 to 12	0.035	0
	20	13 to 17	0.031	0
	20	18 to 22	0.028	0
	20	23 to 27	0.026	0
	20	28 to 32	0.025	0
0.5 to 2 number of strokes n=4	25	8 to 12	0.075	0
	20	13 to 17	0.071	0
	20	18 to 22	0.065	0
	20	23 to 27	0.057	0
	25	28 to 32	0.056	0
	30	33 to 37	0.047	0

Evaluation of Measurement

Calculate perchloroethylene concentration:

$$Y_{[\text{mg/L}]} = A \cdot B \cdot (X_{[\text{ppm}]} + C)$$

Cross Sensitivity

Dichloromethane and chloroform are indicated with lower sensitivity. Trichloroethylene is indicated with nearly the same sensitivity. Petroleum hydrocarbons, benzene, carbon tetrachloride, toluene, 1,1,1-trichloroethane and xylene are not indicated.



ST-90-2001

Propionic Acid 0.3 to 10 g/L

Order No. 67 22 101

Application Range

Determination of propionic acid in water/waste water

Dräger-Tube:	Acetic Acid 5/a
Measuring range:	0.3 to 10 g/L
Number of Strokes (n):	10
Typical Stroke Time:	10 to 30 s
Measurement Time:	approx. 200 s
Sample Volume:	200 mL
Color Change:	blue violet → yellow
Temperature Range:	10 to 30 °C
pH-Measurement:	necessary

Information of Measurement

Using sulfuric acid, the pH-value has to be adjusted to the value of 1.3.

System Parameters (valid for pH 1.3)

Measurement Range [g/L]	Standard Deviation [%]	Temperature [°C]	Parameters	
			B	C
0.3 to 10	25	10 to 30	0.153	0.687

Evaluation of Measurement

Calculate propionic acid concentration:

$$Y_{[g/L]} = A \cdot B \cdot (X_{[ppm]} + C)$$

Cross Sensitivity

Acetic acid and formic acid are indicated with lower sensitivity.

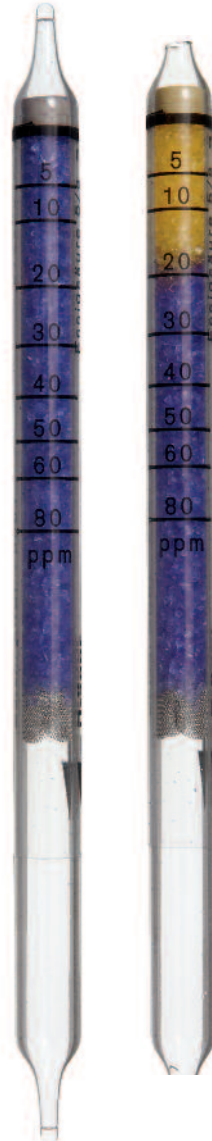

Toluene 1 to 10 mg/L

Order No. 81 01 701

Application Range

Determination of toluene in water/waste water

Dräger-Tube:	Toluene 50/a
Measuring range:	1 to 10 mg/L
Number of Strokes (n):	5
Typical Stroke Time:	20 to 40 s
Measurement Time:	approx. 150 s
Sample Volume:	200 mL
Color Change:	white → brown
Temperature Range:	5 to 30 °C
pH-Measurement:	not necessary

System Parameters

Measurement Range [mg/L]	Standard Deviation [%]	Temperature [°C]	Parameters	
			B	C
1 bis 10	25	5 bis 30	0.037 for X ≥ 50	-20 0 for X < 50

Evaluation of Measurement

Calculate toluene concentration:

$$Y_{[\text{mg/L}]} = A \cdot B \cdot (X_{[\text{ppm}]} + C)$$

Cross Sensitivity

Benzene leads to a weak diffuse reading. Petroleum hydrocarbons, styrene and o-xylene are indicated with lower sensitivity. Phenol is not indicated.



ST-162-2001

Toluene 0.2 to 5 mg/L

Order No. 81 01 661

Application Range

Determination of toluene in water/waste water

Dräger-Tube:	Toluene 5/b
Measuring range:	0.2 to 5 mg/L
Number of Strokes (n):	6
Typical Stroke Time:	60 to 90 s
Measurement Time:	approx. 450 s
Sample Volume:	200 mL
Color Change:	white → yellow green
Temperature Range:	5 to 30 °C
pH-Measurement:	not necessary

System Parameters

Measurement Range [mg/L]	Standard Deviation [%]	Temperature [°C]	Parameters	
			B	C
0.2 to 5	40	5 to 30	0.057	0

Evaluation of Measurement

Calculate toluene concentration:

$$Y_{[\text{mg/L}]} = A \cdot B \cdot (X_{[\text{ppm}]} + C)$$

Cross Sensitivity

Benzene, xylene (all isomere), ethylbenzene and styrene are indicated with different sensitivity. Acetone, ethanol and n-octane do not interfere with the reading. Phenol does not interfere with the reading up to a concentration of 100 mg/L.

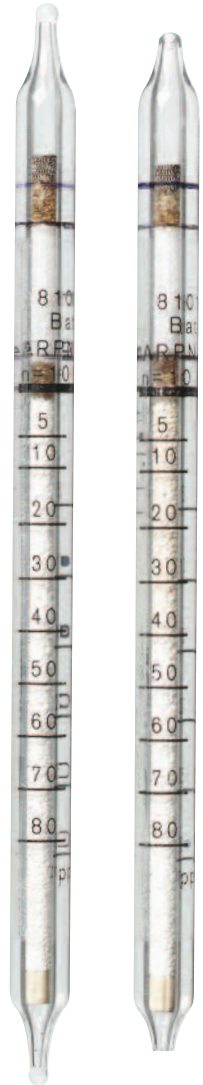

ST-151-2001

1,1,1-Trichloroethane 0.5 to 5 mg/L

Order No. CH 21 101

Application Range

Determination of 1,1,1-trichloroethane in water/waste water

Dräger-Tube:	Trichloroethane 50/d
Measuring range:	0.5 to 5 mg/L
Number of Strokes (n):	5 + 3 desorption strokes at clean air
Typical Stroke Time:	40 to 70 s + 20 to 40 s
Measurement Time:	approx. 550 s + 90 s
Sample Volume:	200 mL
Color Change:	grey → brown red
Temperature Range:	5 to 35 °C
pH-Measurement:	not necessary

System Parameters

Measurement Range [mg/L]	Standard Deviation [%]	Temperature [°C]	Parameters	
			B	C
0.5 to 5	25	5 to 12	0.0059	-50
	25	13 to 25	0.0059	-100
	30	26 to 33	0.0054	-200

Evaluation of Measurement

Calculate 1,1,1-trichloroethane concentration:

$$Y_{[\text{mg/L}]} = A \cdot B \cdot (X_{[\text{ppm}]} + C)$$

Cross Sensitivity

Perchloroethylene, carbon tetrachloride, dichloromethane and trichloroethylene are indicated with lower sensitivity. Petroleum hydrocarbons are not indicated.



D-13345-2010

Trichloroethylene 10 to 100 µg/L

Order No. 81 01 551

Application Range

Determination of trichloroethylene in water/waste water

Dräger-Tube:	Perchloroethylene 0.1/a
Measuring range:	10 to 100 µg/L
Number of Strokes (n):	4
Typical Stroke Time:	2 to 3 minutes
Measurement Time:	approx. 10 minutes
Sample Volume:	200 mL
Color Change:	yellow white → grey blue
Temperature Range:	5 to 30 °C
pH-Measurement:	not necessary

System Parameters

Measurement Range [µg/L]	Standard Deviation [%]	Temperature [°C]	Parameters	
			B	C
10 to 100	30	5 to 10	134	0
		11 to 20	120	-0.01
		21 to 30	90	0

Evaluation of Measurement

Calculate trichloroethylene concentration:

$$Y_{[\mu\text{g/L}]} = A \cdot B \cdot (X_{[\text{ppm}]} + C)$$

Cross Sensitivity

Dichloromethane, chlorobenzene, chloroform, 1,1-dichloroethane and 1,2-dichloroethane are indicated with lower sensitivity. Perchloroethylene is indicated with nearly the same sensitivity. Carbon tetrachloride and 1,1,1-trichloroethane are not indicated.



Trichloroethylene 0.1 to 1 mg/L

Order No. 81 01 501

Application Range

Determination of trichloroethylene in water/waste water

Dräger-Tube:	Perchloroethylene 2/a
Measuring range:	0.1 to 1 mg/L
Number of Strokes (n):	8
Typical Stroke Time:	45 to 65 s
Measurement Time:	approx. 440 s
Sample Volume:	200 mL
Color Change:	yellow white → grey blue
Temperature Range:	5 to 33 °C
pH-Measurement:	not necessary

System Parameters

Measurement Range [mg/L]	Standard Deviation [%]	Temperature [°C]	Parameters	
			B	C
0.1 to 1	30	5 to 10	0.033	0
		11 to 15	0.030	0
		16 to 22	0.024	0
		23 to 28	0.020	0
		29 to 33	0.018	0

Evaluation of Measurement

Calculate trichloroethylene concentration:

$$Y_{[\text{mg/L}]} = A \cdot B \cdot (X_{[\text{ppm}]} + C)$$

Cross Sensitivity

Dichloromethane, chlorobenzene, 1,1-dichloroethane, 1,2 dichloroethane and chloroform are indicated with lower sensitivity. Perchloroethylene is indicated with nearly the same sensitivity. Carbon tetrachloride and 1,1,1-trichloroethane are not indicated.



Trichloroethylene 0.2 to 3 mg/L

Order No. 67 28 541

Application Range

Determination of trichloroethylene in water/waste water

Dräger-Tube:	Trichloroethylene 2/a
Measuring range:	0.2 to 1 mg/L / 0.3 to 3 mg/L
Number of Strokes (n):	8 / 4
Typical Stroke Time:	40 to 80 s
Measurement Time:	approx. 480 s / approx. 240 s
Sample Volume:	200 mL
Color Change:	pale grey → orange
Temperature Range:	4 to 30 °C
pH-Measurement:	not necessary

System Parameters

Number of Strokes	Measurement Range [mg/L]	Standard Deviation [%]	Temperature [°C]	Parameters	
				B	C
n=8	0.2 to 1	25	4 to 10	0.028	3
			11 to 19	0.025	3
			20 to 30	0.021	3
n=4	0.3 to 3	25	4 to 18	0.049	1
			19 to 30	0.044	1

Evaluation of Measurement

Calculate trichloroethylene concentration:

$$Y_{[\text{mg/L}]} = A \cdot B \cdot (X_{[\text{ppm}]} + C)$$

Cross Sensitivity

Dichloromethane, n-hexane, perchloroethylene and chloroform are indicated with lower sensitivity.

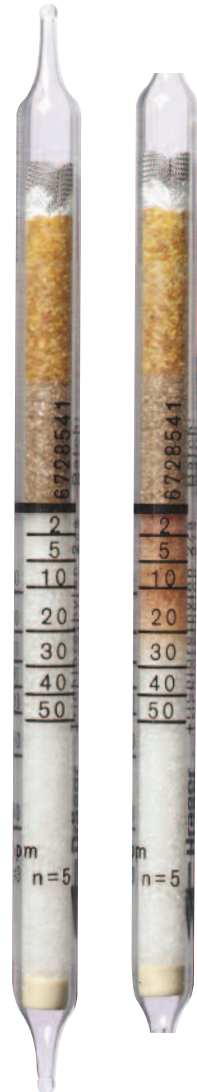

ST-157-2001

Xylene (o, m, p) 0.3 to 10 mg/L

Order No. 67 33 161

Application Range

Determination of xylene in water/waste water

Dräger-Tube:	Xylene 10/a
Measuring range:	0.3 to 10 mg/L
Number of Strokes (n):	8
Typical Stroke Time:	10 to 25 s
Measurement Time:	approx. 140 s
Sample Volume:	200 mL
Color Change:	white → red brown
Temperature Range:	5 to 35 °C
pH-Measurement:	not necessary

System Parameters

Measurement Range [mg/L]	Standard Deviation [%]	Temperature [°C]	Parameters	
			B	C
o-Xylene 0.3 to 10	30	5 to 15 16 to 35	0.048	-7
			0.042	-10
m-Xylene 0.3 to 10	30	5 to 10 11 to 20 21 to 35	0.041	-10
			0.034	-10
			0.028	-10
p-Xylene 0.3 to 10	30	5 to 10 11 to 35	0.029	0
			0.031	-10

Evaluation of Measurement

Calculate xylene concentration:

$$Y_{[\text{mg/L}]} = A \cdot B \cdot (X_{[\text{ppm}]} + C)$$

Cross Sensitivity

Benzene, styrene and toluene are indicated with different sensitivity. Petroleum hydrocarbons and perchloroethylene do not interfere with the reading.

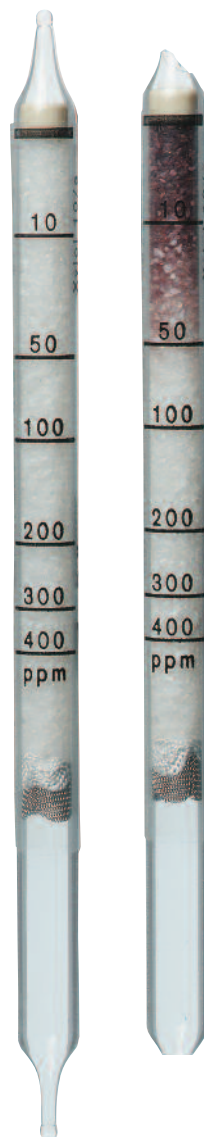

SI-172-2001

Xylene (o, m, p) 0.2 to 5 mg/L

Order No. 81 01 661

Application Range

Determination of xylene in water/waste water

Dräger-Tube:	Toluene 5/b
Measuring range:	0.2 to 5 mg/L
Number of Strokes (n):	6
Typical Stroke Time:	60 to 90 s
Measurement Time:	approx. 450 s
Sample Volume:	200 mL
Color Change:	white → brown violet
Temperature Range:	5 to 30 °C
pH-Measurement:	not necessary

System Parameters

Measurement Range [mg/L]	Standard Deviation [%]	Temperature [°C]	Parameters	
			B	C
0.2 to 5	40	5 to 30	0.057	0

Evaluation of Measurement

Calculate xylene concentration:

$$Y_{[\text{mg/L}]} = A \cdot B \cdot (X_{[\text{ppm}]} + C)$$

Cross Sensitivity

Benzene, toluene, ethylbenzene and styrene are indicated with different sensitivity. Acetone, ethanol and n-octane do not interfere with the reading. Phenol does not interfere with the reading up to a concentration of 100 mg/L

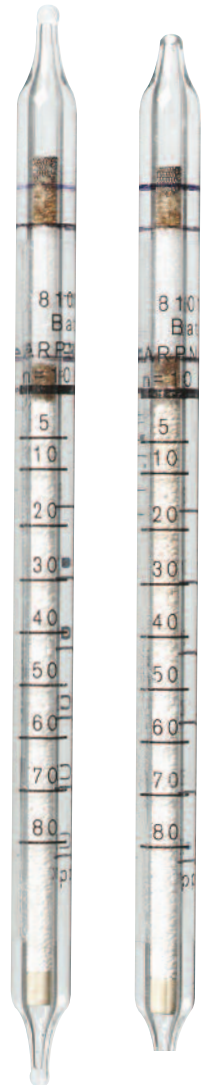

ST-151-2001

5.1.7 Data about Direct Indicating Dräger Diffusion Tubes

Acetic Acid 10/a-D

Order No. 81 01 071

Application Range

Standard Range	Measurement Time
10 to 200 ppm	1 h
5 to 100 ppm	2 h
2.5 to 50 ppm	4 h
1.3 to 25 ppm	8 h

Standard Deviation ± 20 to 25 %
 Color Change blue violet \rightarrow yellow

Ambient Operating Conditions

Temperature	20 to 25 °C
Absolute Humidity	1 to 15 mg H ₂ O / L

Reaction Principle

Acetic acid + pH Indicator \rightarrow yellow reaction product

Cross Sensitivity

Other acid reacting substances are also indicated. It is impossible to measure acetic acid in the presence of other acids.

Formic acid and sulfur dioxide are indicated with about the same sensitivity and color.

Hydrochloric acid is indicated with a lower sensitivity and pink color. Nitrogen dioxide and chlorine also have an influence on the indication.

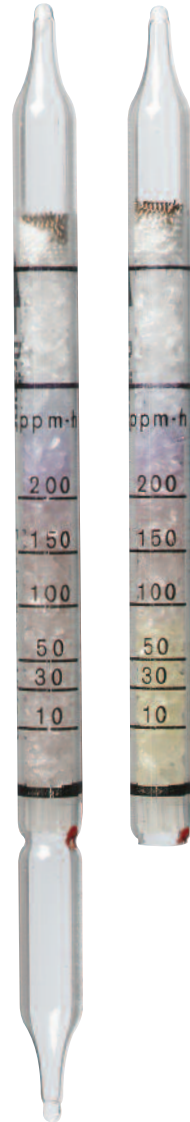

ST-229-2001

Ammonia 20/a-D

Order No. 81 01 301

Application Range

Standard Range	Measurement Time
20 to 1,500 ppm	1 h
10 to 750 ppm	2 h
4 to 300 ppm	5 h
2.5 to 200 ppm	8 h

Standard Deviation ± 15 to 20 %

Color Change yellow \rightarrow blue

Ambient Operating Conditions

Temperature: 0 to 40 °C

Absolute Humidity 1 to 16 mg H₂O / L

Reaction Principle

NH₃ + Bromophenol blue \rightarrow blue reaction product

Cross Sensitivity

Other basic reacting compounds are also indicated. It is impossible to measure ammonia in the presence of other basic gases.

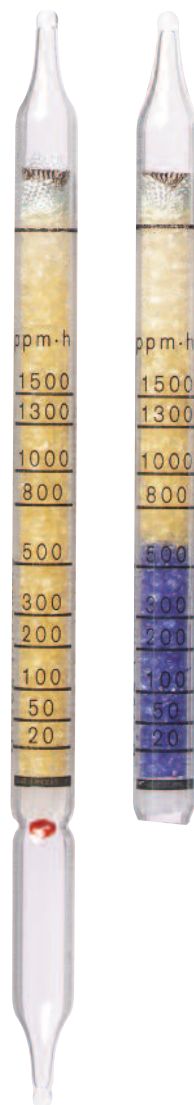

A

Butadiene 10/a-D

Order No. 81 01 161

Application Range

Standard Range	Measurement Time
10 to 300 ppm	1 h
5 to 150 ppm	2 h
2.5 to 75 ppm	4 h
1.3 to 40 ppm	8 h

Standard Deviation	± 20 to 25 %
Color Change	pink → light brown

Ambient Operating Conditions

Temperature	20 to 25 °C
Absolute Humidity	1 to 15 mg H ₂ O / L

Reaction Principle

$\text{H}_2\text{C}=\text{CH}-\text{CH}=\text{CH}_2 + \text{KMnO}_4 \rightarrow \text{Mn}^{\text{IV}} + \text{various oxidation products}$

Cross Sensitivity

Other organic compounds with carbon - carbon double bonds are also indicated, for example:

Substance measured	Concentration present	Measuring period	Indication
Chloroprene	10 mL/m ³ (ppm)	5 hours approx.	50 ppm x h
Ethylene	10 mL/m ³ (ppm)	6 hours approx.	50 ppm x h (diffuse)

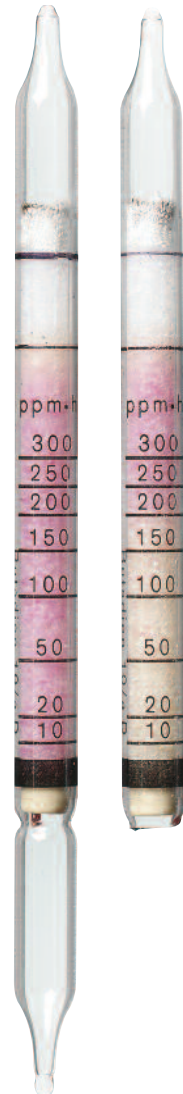

Carbon Dioxide 500/a-D

Order No. 81 01 381

Application Range

Standard Range	Measurement Time
500 to 20,000 ppm	1 h
250 to 10,000 ppm	2 h
125 to 5,000 ppm	4 h
65 to 2,500 ppm	8 h

Standard Deviation ± 20 to 25 %

Color Change blue \rightarrow white

Ambient Operating Conditions

Temperature: 10 to 30 °C

Absolute Humidity 1 to 16 mg H₂O / L

Reaction Principle

CO₂ + pH Indicator \rightarrow white reaction product

Cross Sensitivity

Other acid reacting substances are also indicated, but normally this is not a problem unless the concentrations exceed the TLVs. For example, the following substances do not interfere during a 4-hour measurement.

- 100 ppm ammonia
- 50 ppm sulfur dioxide
- 50 ppm nitrogen dioxide
- 50 ppm hydrogen sulfide
- 25 ppm hydrochloric acid



B

Carbon Dioxide 1%/a-D

Order No. 81 01 051

Application Range

Standard Range	Measurement Time
1 to 30 Vol.-%	1 h
0.3 to 10 Vol.-%	3 h
0.2 to 6 Vol.-%	5 h
0.13 to 4 Vol.-%	8 h

Standard Deviation	± 20 to 25 %
Color Change	blue → white

Ambient Operating Conditions

Temperature	10 to 30 °C
Absolute Humidity	1 to 15 mg H ₂ O / L

Reaction Principle

CO₂ + pH Indicator → white reaction product

Cross Sensitivity

Other acid reacting substances are also indicated, but normally this is not a problem unless the concentrations exceed the TLVs. For example, the following substances do not interfere during a 8-hour measurement.

- 100 ppm ammonia
- 50 ppm sulfur dioxide
- 50 ppm nitrogen dioxide
- 50 ppm hydrogen sulfide
- 25 ppm hydrochloric acid



Carbon Monoxide 50/a-D

Order No. 67 33 191

Application Range

Standard Range	Measurement Time
50 to 600 ppm	1 h
25 to 300 ppm	2 h
10 to 120 ppm	5 h
6 to 75 ppm	8 h

Standard Deviation	± 20 to 25 %
Color Change	yellow → grey black

Ambient Operating Conditions

Temperature:	10 to 25 °C
Absolute Humidity	3 to 15 mg H ₂ O / L

Reaction Principle

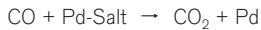

Cross Sensitivity

There is no interference during a 4-hour measurement by:

- 100 ppm ammonia
- 4 ppm sulfur dioxide
- 25 ppm nitrogen dioxide
- 2,000 ppm n-butane

Following a 4-hour exposure, 20 ppm hydrogen sulfide simulates an indication of approximately 50 ppm x h carbon monoxide.

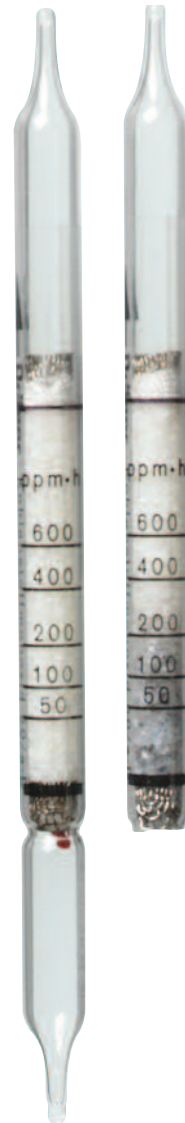

C

Ethanol 1000/a-D

Order No. 81 01 151

Application Range

Standard Range	Measurement Time
1,000 to 25,000 ppm	1 h
500 to 12,500 ppm	2 h
200 to 5,000 ppm	5 h
125 to 3,100 ppm	8 h

Standard Deviation	± 20 to 25 %
Color Change	yellow → green

Ambient Operating Conditions

Temperature	0 to 40 °C
Absolute Humidity	1 to 16 mg H ₂ O / L

Reaction Principle



Cross Sensitivity

Other organic compounds are also indicated, but with different sensitivities. It is impossible to differentiate between them.

Methyl ethyl ketone and methanol are indicated with about twice the sensitivity (e.g. 500 ppm x h MEK gives an indication of 1,000 ppm x h).

Isopropanol is indicated with about half the sensitivity.

Acetone and ethyl acetate in the TLV range have no influence on the indication.



Hydrochloric Acid 10/a-D

Order No. 67 33 111

Application Range

Standard Range	Measurement Time
10 to 200 ppm	1 h
5 to 100 ppm	2 h
2.5 to 50 ppm	4 h
1.3 to 25 ppm	8 h

Standard Deviation ± 20 to 25 %

Color Change blue \rightarrow yellow

Ambient Operating Conditions

Temperature: 18 to 22 °C

Absolute Humidity 3 mg H₂O / L

Only gaseous hydrogen chloride is measured. Higher atmospheric humidities can lead to the formation of HCl aerosols, which are not quantitatively measured.

Reaction Principle

HCl + Bromophenol blue \rightarrow yellow reaction product

Cross Sensitivity

10 ppm Sulfur dioxide has no influence on the indication during an 8-hour measurement.

Other acid gases are also indicated, but with different discolorations and sensitivities.

Nitrogen dioxide discolors the indicating layer red brown.

After 4-hours, 5 ppm chlorine simulates a hydrochloric acid indication of 35 ppm x h.

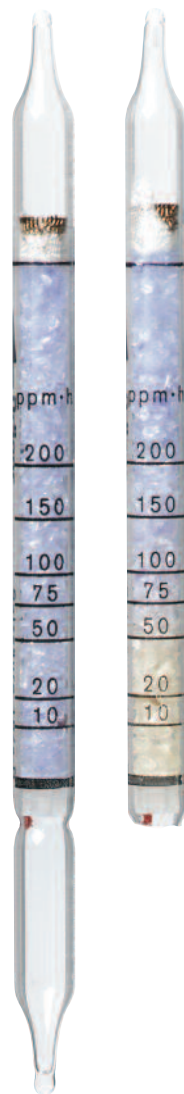

E

Hydrocyanic Acid 20/a-D

Order No. 67 33 221

Application Range

Standard Range	Measurement Time
20 to 200 ppm	1 h
10 to 100 ppm	2 h
5 to 50 ppm	4 h
2.5 to 25 ppm	8 h

Standard Deviation ± 20 to 25 %

Color Change yellow → red

Ambient Operating Conditions

Temperature 5 to 30 °C

Absolute Humidity 3 to 15 mg H₂O / L

Reaction Principle

- $\text{HCN} + \text{HgCl}_2 \rightarrow \text{HCl}$
- $\text{HCl} + \text{pH Indicator} \rightarrow \text{red reaction product}$

Cross Sensitivity

No interference by:

- 40 ppm ammonia
- 10 ppm hydrogen sulfide
- 5 ppm nitrogen dioxide
- 5 ppm hydrochloric acid
- 2 ppm sulfur dioxide

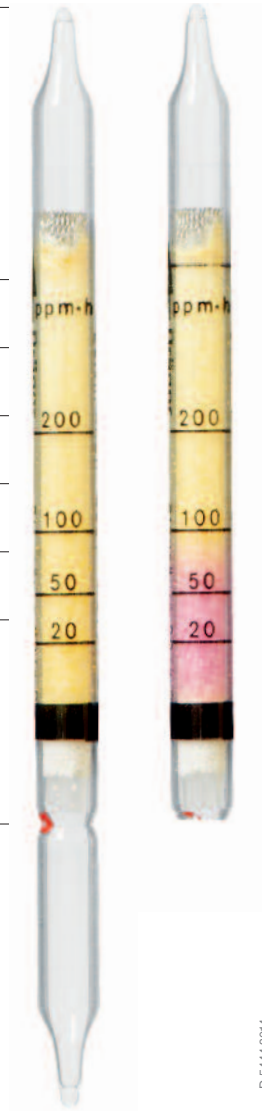

Hydrogen Sulfide 10/a-D

Order No. 67 33 091

Application Range

Standard Range	Measurement Time
10 to 300 ppm	1 h
5 to 150 ppm	2 h
2.5 to 75 ppm	4 h
1.3 to 40 ppm	8 h

Standard Deviation ± 20 to 25 %

Color Change white \rightarrow brown

Ambient Operating Conditions

Temperature: 0 to 40 °C

Absolute Humidity < to 15 mg H₂O / L

Reaction Principle

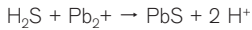

Cross Sensitivity

50 ppm Hydrochloric acid does not interfere.

In the presence of 50 ppm ammonia for 2 hours, the hydrogen sulfide indication will show minus errors of about 20%.

The influence of chlorine and nitrogen dioxide in the TLV range is negligible, but higher concentrations lead to minus errors.

The influence of sulfur dioxide in the TLV range is also negligible, but higher concentrations lead to plus errors.



Nitrogen Dioxide 10/a-D

Order No. 81 01 111

Application Range

Standard Range	Measurement Time
10 to 200 ppm	1 h
5 to 100 ppm	2 h
2.5 to 50 ppm	4 h
1.3 to 25 ppm	8 h

Standard Deviation ± 20 to 25 %

Color Change white → yellow orange

Ambient Operating Conditions

Temperature 0 to 40 °C

Absolute Humidity 5 to 15 mg H₂O / L

Reaction Principle

 $\text{NO}_2 + o\text{-Tolidine} \rightarrow \text{yellow orange reaction product}$

Cross Sensitivity

Chlorine and ozone are also indicated with approximately half the indicating sensitivity (e.g. 20 ppm x h chlorine gives an indication of 10 ppm x h).

No influence by 5 ppm sulfur dioxide and 100 ppm ammonia.

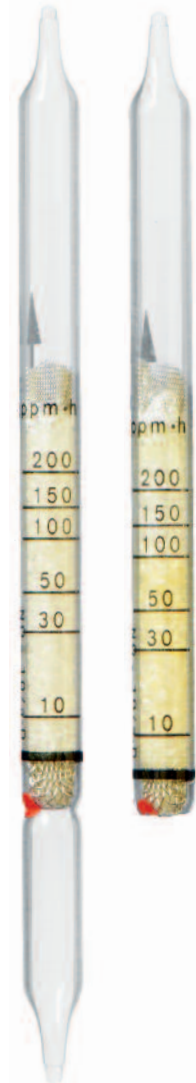

D-5447-2014

Perchloroethylene 200/a-D

Order No. 81 01 401

Application Range

Standard Range	Measurement Time
200 to 1,500 ppm	1 h
100 to 750 ppm	2 h
50 to 380 ppm	4 h
25 to 200 ppm	8 h

Standard Deviation	± 20 to 25 %
Color Change	white → yellow orange

Ambient Operating Conditions

Temperature:	0 to 35 °C
Absolute Humidity	5 to 12 mg H ₂ O / L

Reaction Principle

- $\text{Cl}_2\text{C}=\text{CCl}_2 + \text{Cr}^{\text{VI}} \rightarrow \text{Cl}_2$
- $\text{Cl}_2 + \text{o-Tolidine} \rightarrow \text{yellow orange reaction product}$

Cross Sensitivity

Other chlorinated hydrocarbons are also indicated, but with different sensitivities.

Trichloroethylene and 1,1,1-trichloroethane are indicated with about the same sensitivity.

Chlorine (above 10 ppm x h) and nitrogen dioxide (above 10 ppm x h) will discolor the indicating layer.

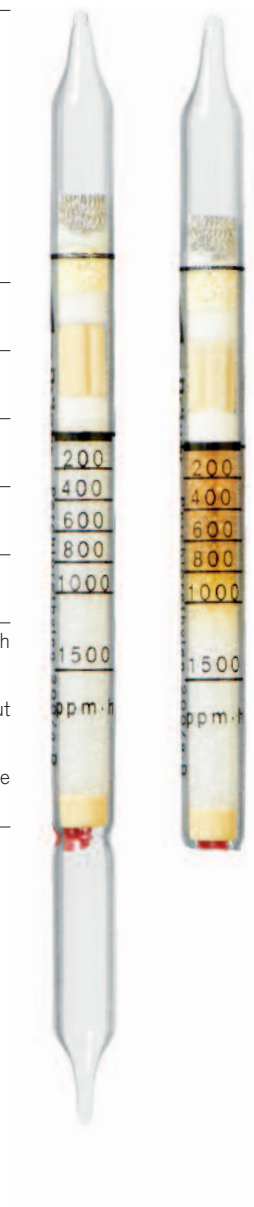

D-5464-2014

Sulfur Dioxide 5/a-D

Order No. 81 01 091

Application Range

Standard Range	Measurement Time
5 to 150 ppm	1 h
2.5 to 75 ppm	2 h
1.3 to 38 ppm	4 h
0.7 to 19 ppm	8 h

Standard Deviation	± 20 to 25 %
Color Change	blue violet → light yellow

Ambient Operating Conditions

Temperature	10 to 30 °C
Absolute Humidity	1 to 15 mg H ₂ O / L

Reaction Principle

SO₂ + pH Indicator → light yellow reaction product

Cross Sensitivity

It is impossible to measure sulfur dioxide in the presence of other acidic substances.

During a 6-hour measurement, 10 ppm hydrochloric acid produces a pink color up to 25 ppm x h. During a 4-hour measurement, 20 ppm acetic acid produces a yellow color up to 60 ppm x h.

Nitrogen dioxide and chlorine also have an influence on the indication.

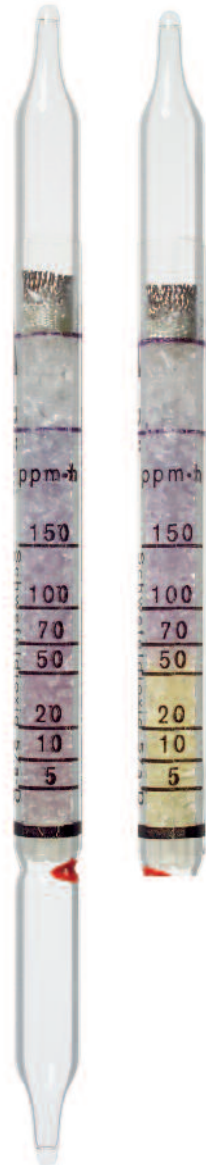

ST-323-2008

Toluene 100/a-D

Order No. 81 01 421

Application Range

Standard Range	Measurement Time
100 to 3,000 ppm	1 h
50 to 1,500 ppm	2 h
25 to 750 ppm	4 h
13 to 380 ppm	8 h

Standard Deviation ± 20 to 25 %
 Color Change yellow → brown

Ambient Operating Conditions

Temperature:	10 to 40 °C
Absolute Humidity	1 to 15 mg H ₂ O / L

Reaction Principle

$C_6H_5CH_3 + Ce(SO_4)_2 \rightarrow$ brown reaction product

Cross Sensitivity

Other aromatic hydrocarbons are also indicated, but with different sensitivities.

During a 6-hour measurement, 100 ppm ethyl benzene produces a diffuse indication up to 600 ppm x h.

During a 6-hour measurement, 100 ppm xylene produces an indication up to 300 ppm x h.

Benzene in the TLV range does not interfere.

Aliphatic hydrocarbons are not indicated.



S

Trichloroethylene 200/a-D

Order No. 81 01 441

Application Range

Standard Range	Measurement Time
200 to 1,000 ppm	1 h
100 to 500 ppm	2 h
50 to 250 ppm	4 h
25 to 125 ppm	8 h

Standard Deviation	± 20 to 25 %
Color Change	white → yellow orange

Ambient Operating Conditions

Temperature	0 to 35 °C
Absolute Humidity	5 to 12 mg H ₂ O / L

Reaction Principle

- $\text{HCIC}=\text{CCl}_2 + \text{Cr}^{\text{VI}} \rightarrow \text{Cl}_2$
- $\text{Cl}_2 + \text{o-Tolidine} \rightarrow \text{yellow orange reaction product}$

Cross Sensitivity

Other chlorinated hydrocarbons are also indicated, but with different sensitivities.

Perchloroethylene is indicated with a slightly higher sensitivity and 1,1,1-trichloroethane with about twice the sensitivity (e.g. 200 ppm x h 1,1,1-trichloroethane gives an indication of 400 ppm x h).

Chlorine and nitrogen dioxide in dosages higher than 10 ppm x h also discolor the indicating layer.

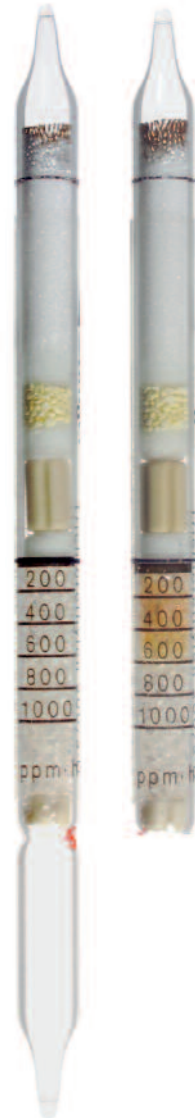

5.1.8 Data about Dräger Sampling Tubes and Systems

Activated Charcoal Tube Type B/G

Order No. 81 01 821

Application Range

Adsorbate	organic compounds which adsorb on activated charcoal
Sorption agent	coconut shell charcoal
Adsorption layer	300 mg / 700 mg
Backup layer	700 mg / 300 mg
Tube length	125 mm
Outside diameter	7 mm
Inside diameter	5 mm

Advice for sample-taking

This tube can be used optionally in both directions. The type G tube can be used especially for sample taking of organic compounds, if high concentrations in the air (e.g. exhaust air) are expected. For the workplace measurement the tube type B can be used (Measurement in AGW or TLV Range). When the sampling is finished, the tubes have to be closed with the polyethylene caps and the sample direction is to be written down on the sample taking protocol.

Note concerning the analysis

The enriched volatile organic compounds are analysed in accordance with the procedures recommended by BGIA, DFG, NIOSH, OSHA and HSE.

For evaluation of the sampling tubes and systems please contact Dräger.



D-13327-2010

Activated Charcoal Tube Type BIA

Order No. 67 33 011

Application Range

Adsorbate	organic compounds which adsorb on activated charcoal
Sorption agent	coconut shell charcoal
Adsorption layer	300 mg
Backup layer	600 mg
Tube length	125 mm
Outside diameter	7 mm
Inside diameter	5 mm

Advice for sample-taking

This construction is developed, for a high adsorption capacity of the sampling layer. This tube is typically sufficient for sampling in the range of limit value measurements. If higher concentrations of harmful substances are expected, the sampling tube must be inserted with the air flow opposite to the flow indicating arrow (long layer in front; note in the sampling record!). After sampling the tube should be sealed with the polyethylene supplied caps.

Note concerning the analysis

The enriched volatile organic compounds are analysed in accordance with the procedures recommended by BGIA, DFG, NIOSH, OSHA and HSE.

For evaluation of the sampling tubes and systems please contact Dräger.



D-13314-2010

A

Activated Charcoal Tube Type G

Order No. 67 28 831

Application Range

Adsorbate	organic compounds which adsorb on activated charcoal
Sorption agent	coconut shell charcoal
Adsorption layer	750 mg
Backup layer	250 mg
Tube length	125 mm
Outside diameter	7 mm
Inside diameter	5 mm

Advice for sample-taking

Because of the large quantity of activated charcoal in the sampling layer these activated charcoal tubes are specially suitable for the sampling of organic compounds which are present in high concentrations in the air sample. For example, the analysis of exhaust air for the determination of the emission of a harmful substance.

After sampling the tube must be sealed with the polyethylene supplied caps

Note concerning the analysis

The enriched volatile organic compounds are analysed in accordance with the procedures recommended by BGIA, DFG, NIOSH, OSHA and HSE.

For evaluation of the sampling tubes and systems please contact Dräger.



ST-557-2008

Activated Charcoal Tube Type NIOSH

Order No. 67 28 631

Application Range

Adsorbate	organic compounds which adsorb on activated charcoal
Sorption agent	coconut shell charcoal
Adsorption layer	100 mg
Backup layer	50 mg
Tube length	70 mm
Outside diameter	6 mm
Inside diameter	4 mm

Advice for sample-taking

The air to be analysed must be drawn through the tube at a constant flow rate between 0.01 and 0.2 L/min. During sampling the activated charcoal tube should be in a vertical position. This guarantees a constant flow of air through the activated charcoal.

NIOSH points out in its regulations that the absorption capacity of activated charcoal is affected by high air humidity, which may result in pre-mature breakthrough of the substance to be measured into the control layer. A special tube adapter (order no. 67 28639) is necessary in order to use Dräger pumps for sampling. After sampling the tube should be sealed with the polyethylene supplied caps.

Note concerning the analysis

The enriched volatile organic compounds are analysed in accordance with the procedures recommended by BGIA, DFG, NIOSH, OSHA and HSE.

For evaluation of the sampling tubes and systems please contact Dräger.



A

Aldehyde Sampling Set

Order No. 64 00 271

Application Range

Measurable substances	aldehydes, e.g. acetaldehyde acrolein formaldehyde glutarialdehyde
Reaction medium	with 2,4-dinitrophenylhydrazine impregnated fiberglass filter
Reaction product	hydrazone derivate
Flow	0.1 to 1 L/min
Total volume	10 to 100 L
Storage before	at 7 °C in a refrigerator,
Sampling	max. 9 months

Advice for sample-taking

After sampling the loaded fiberglass filter must be stored in a tightly closed container, stored in a cool place and analysed immediately in the laboratory.

The analytical determination is by high performance liquid chromatography (HPLC) after extraction of the filter.

Note concerning the analysis

The enriched volatile organic compounds are analysed in accordance with the procedures recommended by BGIA, DFG, NIOSH, OSHA and HSE.

For evaluation of the sampling tubes and systems please contact Dräger.

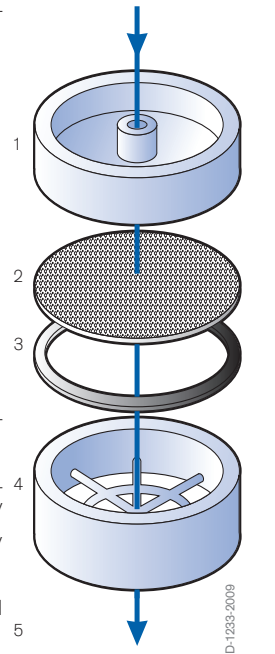

- 1 top
- 2 impregnated fiber glass filter
- 3 flat gasket
- 4 base
- 5 pump

Sampling Tube Amines

Order No. 81 01 271

Application Range

Adsorbate	primary, secondary and tertiary aliphatic amines, dialkyl sulfates, N-heterocyclene
Sorption agent	special silicagel
Adsorption layer	300 mg
Backup layer	300 mg
Tube length	125 mm
Outside diameter	7 mm
Inside diameter	5 mm

Advice for sample-taking

While sampling the air to be analysed should be sucked in the direction of the imprinted arrow through the tube with a constant flow between approximately 0.3 and 1 L/min. The volume of air to be sucked through is within the range of 1 to 100 L. After sampling the tube has to be sealed with the polyethylene caps supplies.

Note concerning the analysis

The enriched volatile organic compounds are analysed in accordance with the procedures recommended by BGIA, DFG, NIOSH, OSHA and HSE.

For evaluation of the sampling tubes and systems please contact Dräger.



ST-1237-2008

Isocyanate-Sampling-Set

Order No. 64 00 131

Application Range

Measurable substances	isocyanates, e.g. 2,4-toluylene diisocyanate (TDI) 2,6-toluylene diisocyanate (TDI) diphenylmethane-4,4' - diisocyanate (MDI) hexamethylene diisocyanate (HDI)
Reaction medium	with amine compound impregnated fiberglass filter
Reaction product	urea derivate
Flow	1 to 2 L/min
Total volume	20 to 100 L
Storage before	at 7 °C in a refrigerator,
Sampling	max. 9 months

Advice for sample-taking

After sampling the loaded fiberglass filter must be stored in the tightly closed container, stored in a cool place and analysed immediately in the laboratory.

Note concerning the analysis

The enriched volatile organic compounds are analysed in accordance with the procedures recommended by BGIA, DFG, NIOSH, OSHA and HSE.

For evaluation of the sampling tubes and systems please contact Dräger.

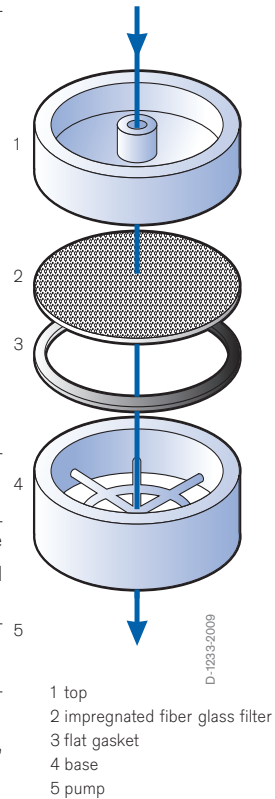

Nitrous-Oxide Diffusion Sampler

Order No. 81 01 472

Application Range

Adsorbate	nitrous oxide (laughing gas)
Sorption agent	molecular sieve
Adsorption layer	400 mg
Standard range of measurement	2.5 to 500 ppm
Sampling period	15 min to 8 hours
Diffusion rate	0.03 µg/ppm x h
Sampling rate	0.27 mL/min
Adsorption capacity	120 µg
Tube length	115 mm
Outside diameter	7 mm
Inside diameter	5 mm

Permissible ambient conditions

Temperature	5 to 35°C
Moisture	below 20 mg/L H ₂ O
Atmospheric pressure	below 1050 hPa
Air velocity	at least 1 cm/s

Advice for sample-taking

The sampling time of nitrous-oxide diffusion sampler depends on the expected oxide nitrous concentration in the air to be analysed. The following sampling times are recommended in the case of measurements in the range of 5 to 100 mL/m³ (ppm) nitrous oxide:

Nitrous oxide concentration	Recommended sampling time
5 ppm	4 to 8 h
25 ppm	1 to 8 h
50 ppm	30 min to 8 h
100 ppm	15 min to 8 h

After sampling the tube must be sealed with the polyethylene supplied caps.

Note concerning the analysis

The analysis is made according to DFG method No. 2 "Dinitrogen monoxide" via thermodesorption and infrared spectroscopy. For evaluation of the sampling tubes and systems please contact Dräger.



ST-89-2001

Diffusion Sampler ORSA

Order No. 67 28 891 / 67 28 919 / 64 00 365

Application Range

Adsorbate	organic compounds which adsorb on activated charcoal by diffusion
Sorption agent	coconut shell coal
Adsorption layer	400 mg
Adsorption capacity	max. 10 mg, depends on substance
Diffusion rate	1 to 4 $\mu\text{g/ppm} \times \text{h}$, depends on substance
Sampling rate	5 to 10 mL/min, depends on substance
Response time	approx. 2 s
Standard range of measurement	0.1- to 3-times the limit value for most organic solvents for a sampling period of 8 h
Sampling period	0.5 to 8 h for measurement in limit value range
Diffusion cross section	0.88 cm^2
Diffusion distance	0.5 cm
Diffusion barrier	acetate cellulose
Diffusion resistance coefficient	0.8
Apparatus constant	0.71 cm^{-1}

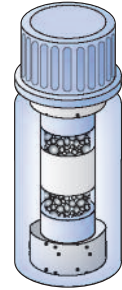

ST-1245-2008

Transportation bottle with diffusion sampler

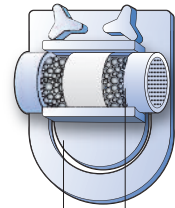

ST-1246-2008

Holder Sampling Tube

Permissible ambient conditions

Temperature	5 to 40°C
Moisture	5 to 80 % at 20°C
Atmospheric pressure	below 1050 hPa
Air velocity	at least 1 cm/s

Advice for sample-taking

Air sampling is carried out in the previously determined measuring period which should be documented. After sample-taking the sampling tube is sent to the laboratory for analysis in the tightly sealed glass bottle.

Note concerning the analysis

The enriched volatile organic compounds are analysed in accordance with the procedures recommended by BGIA, DFG, NIOSH, OSHA and HSE. For evaluation of the sampling tubes and systems please contact Dräger.

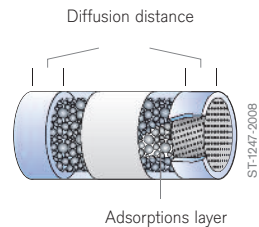

ST-1247-2008

Silica Gel Tubes Type BIA

Order No. 67 33 021

Application Range

Adsorbate	organic compounds which adsorb on silicagel
Sorption agent	silicagel
Adsorption layer	500 mg
Backup layer	1,000 mg
Tube length	125 mm
Outside diameter	7 mm
Inside diameter	5 mm

Advice for sample-taking

This construction is developed, for a high adsorption capacity of the sampling layer. This tube is typically sufficient for sampling in the range of limit value measurements. If higher concentrations of harmful substances are expected, the sampling tube must be inserted with the air flow opposite to the flow indicating arrow (long layer in front; note in the sampling record!). After sampling the tube must be sealed with the polyethylene supplied caps.

Note concerning the analysis

The enriched volatile organic compounds are analysed in accordance with the procedures recommended by BGIA, DFG, NIOSH, OSHA and HSE.

For evaluation of the sampling tubes and systems please contact Dräger.



D-13315-2010

Silica Gel Tubes Type G

Order No. 67 28 851

Application Range

Adsorbate	organic compounds which adsorb on silicagel
Sorption agent	silicagel
Adsorption layer	1100 mg
Backup layer	450 mg
Tube length	125 mm
Outside diameter	7 mm
Inside diameter	5 mm

Advice for sample-taking

Because of the large quantity of silicagel in the sampling layer these silicagel tubes are specially suitable for the sampling of organic compounds which are present in high concentrations in the air sample. For example the analysis of exhaust air for the determination of the emission of a harmful substance. After sampling the tube must be sealed with the polyethylene supplied caps.

Note concerning the analysis

The enriched volatile organic compounds are analysed in accordance with the procedures recommended by BGIA, DFG, NIOSH, OSHA and HSE.

For evaluation of the sampling tubes and systems please contact Dräger.



Silica Gel Tubes Type NIOSH

Order No. 67 28 811

Application Range

Adsorbate	organic compounds which adsorb on silicagel
Sorption agent	silicagel
Adsorption layer	140 mg
Backup layer	70 mg
Tube length	70 mm
Outside diameter	6 mm
Inside diameter	4 mm

Advice for sample-taking

The air to be analysed must be drawn through the tube at a constant flow rate between 0.01 and 0.2 L/min. During sampling the silicagel tube should be in a vertical position. This guarantees a constant flow through the silicagel.

NIOSH points out in its regulations that the absorption capacity of silicagel is affected by high air humidity, which may result in premature breakthrough of the substance to be measured into the control layer.

A special tube adapter (order no. 67 28639) is necessary in order to use Dräger pumps for sampling. After sampling the tube must be sealed with the polyethylene supplied caps.

Note concerning the analysis

The enriched volatile organic compounds are analysed in accordance with the procedures recommended by BGIA, DFG, NIOSH, OSHA and HSE.

For evaluation of the sampling tubes and systems please contact Dräger.



ST-100-2001

5.2 Dräger-Chips-Measurement-System

5.2.1 Explanation to the Data about Dräger-Chips

Measuring Range

The chip is calibrated at standard conditions 20 °C and 50 % r. h. In case of influences by temperature or humidity, correction factors are stated. In general chips can be stored up to two years.

Measuring Time

The typical measuring time for selected concentrations is given in minutes or seconds. The speed of the measurement depends on the concentration to be measured. Therefore, the measuring time is not constant, e. g. the higher the concentration, the shorter the measuring time.

Ambient Operating Conditions

The measuring range of a chip is influenced by the ambient temperature and humidity. The recommended temperature range is given in °C and the absolute humidity limits are given in mg H₂O/L.

In cases, where influences caused by temperature or humidity occur, correction factors are stated in % of the measured value per °C or in % of the measured value per mg H₂O/L.

The Chip-Measurement-System can be used in the range of 700 to 1100 hPa air pressure. A correction within this range is not necessary.

Standard Deviation

The standard deviation is a measure of the incidental deviations of the indicated values from their mean value. The standard deviation, which is actually a coefficient of variation (i. e. relative standard deviation), is given as a percentage and relates to the mean value. According to the first confidence interval 1σ , as it applies to Dräger-Chips, 68.3 % of all measured values are within this standard deviation range.

Cross Sensitivity

The chips are calibrated for a specific contaminant, but under other than ideal conditions, other interfering contaminants may also be present. Other contaminants that influence the measurement are described as being cross sensitive. The information given under the cross sensitivity section indicates which contaminants can influence the measurement and which contaminants would not influence the measurement. However, this information does not address all possibilities.

5.2.2 Data about Dräger Chips for Short-Term Measurements

Acetic Acid 2 - 50 ppm

Order No. 64 06 330

Measuring Range:	2 to 50 ppm (20 °C, 50% r.h.)
Measuring Time:	approx. 40 to 300 s
Rel. Standard deviation:	± 17%
Ambient Operating Conditions	
Temperature:	0 to 40 °C
Humidity:	1 to 30 mg/L (corresp. 2 to 60% r.h. at 40 °C)
Air Pressure:	700 to 1100hPa
Cross Sensivity	
Formic acid is indicated with the same sensitivity.	

Acetone 40 - 600

Order No. 64 06 470

Measuring Range:	40 to 600 ppm (20 °C, 50% r.h.)
Measuring Time:	approx. 60 to 600s
Rel. Standard deviation:	± 16%
Ambient Operating Conditions	
Temperature:	5 to 40 °C
Humidity:	0 to 30 mg/L (corresp. 0 to 100% r.h. at 30 °C)
Air Pressure:	700 to 1100hPa
Cross Sensivity	
Substance	Display of Analyzer indicates
200 ppm Methylethylketon	approx. 370 ppm
100 ppm Methylisobutylketon	approx. 240 ppm
100 ppm Methanol	approx. 200 ppm
500 ppm Ethanol	approx. 500 ppm
250 ppm i-Propanol	approx. 290 ppm

Ammonia 0.2 - 5 ppm

Order No. 64 06 550

Measuring Range:	0.2 to 5 ppm (20 °C, 50% r.h.)
Measuring Time:	approx. 100 to 600 s
Rel. Standard deviation:	± 14%
Ambient Operating Conditions	
Temperature:	0 to 40 °C
Humidity:	1 to 30 mg/L (corresp. 2 to 60% r.h. at 40 °C)
Air Pressure:	700 to 1100hPa

Cross Sensivity

Acid gases can cause minus errors. Other basic substances such as organic amines are indicated with differing sensitivity.

Ammonia 2 - 50 ppm

Order No. 64 06 130

Measuring Range:	2 to 50 ppm (20 °C, 50% r.h.)
Measuring Time:	approx. 15 to 140 s
Rel. Standard deviation:	± 12%
Ambient Operating Conditions	
Temperature:	0 to 40 °C
Humidity:	1 to 40 mg/L (corresp. 2 to 80% r.h. at 40 °C)
Air Pressure:	700 to 1100hPa

Cross Sensivity

No influence at 10 ppm NH₃ by

≤ 200 ppm hydrogen sulfide

≤ 200 ppm sulfur dioxide

Other basic substances such as organic amines are indicated with differing sensitivity.

Ammonia 10 - 150 ppm

Order No. 64 06 020

Measuring Range:	10 to 150 ppm (20 °C, 50% r.h.)
Measuring Time:	approx. 15 to 50 s
Rel. Standard deviation:	± 10%
Ambient Operating Conditions	
Temperature:	0 to 40 °C
Humidity:	1 to 40 mg/L (corresp. 2 to 80% r.h. at 40 °C)
Air Pressure:	700 to 1100hPa
Cross Sensivity	
No influence at 25 ppm NH ₃ by	<ul style="list-style-type: none"> ≤ 2000 ppm hydrogen sulfide ≤ 2000 ppm sulfur dioxide
Other basic substances such as organic amines are indicated with differing sensitivity.	

Ammonia 100 - 2000 ppm

Order No. 64 06 570

Measuring Range:	100 to 2000 ppm (20 °C, 50% r.h.)
Measuring Time:	approx. 15 to 120 s
Rel. Standard deviation:	± 10%
Ambient Operating Conditions	
Temperature:	0 to 40 °C
Humidity:	1 to 30 mg/L (corresp. 2 to 60% r.h. at 40 °C)
Air Pressure:	700 to 1100hPa
Cross Sensivity	
Acid gases can cause minus errors, basic substances such as organic amines are indicated with differing sensitivity. There is no indication due to 200 ppm SO ₂ or 200 ppm H ₂ S, cause however in presence of NH ₃ substantial minus errors.	

Benzene 50 - 2500 ppb

Order No. 64 06 600

Measuring Range:	50 to 2500 ppb
Measuring Time:	approx. 80 to 600s
Rel. Standard deviation:	± 25%
Ambient Operating Conditions	
Temperature:	0 to 30 °C
Humidity:	1 to 20 mg/L (corresp. 3 to 65% r.h. at 30 °C)
Air Pressure:	700 to 1100hPa
Cross Sensivity	
No influence at 250 ppb benzene by	<ul style="list-style-type: none"> ≤ 10 ppm toluene ≤ 10 ppm xylene ≤ 200 ppm n-octane

Benzene 0.2 - 10 ppm

Order No. 64 06 030

A

Measuring Range:	0.2 to 10 ppm (20 °C, 50% r.h.)
Measuring Time:	approx. 35 to 300 s
Rel. Standard deviation:	± 25%
Ambient Operating Conditions	
Temperature:	0 to 40 °C
Humidity:	1 to 30 mg/L (corresp. 2 to 60% r.h. at 40 °C)
Air Pressure:	700 to 1100hPa
Cross Sensivity	
No influence at 1 ppm benzene by	<ul style="list-style-type: none"> ≤ 50 ppm toluene ≤ 50 ppm xylene ≤ 800 ppm n-octane

Benzene 0.5 - 10 ppm

Order No. 64 06 160

Measuring Range:	0.5 to 10 ppm (20 °C, 50% r.h.)
Measuring Time:	approx. 35 to 225 s
Rel. Standard deviation:	± 25%
Ambient Operating Conditions	
Temperature:	0 to 40 °C
Humidity:	1 to 40 mg/L (corresp. 2 to 80% r.h. at 40 °C)
Air Pressure:	700 to 1100hPa
Cross Sensivity	
No influence at 1 ppm benzene by	
	≤ 50 ppm toluene
	≤ 50 ppm xylene
	≤ 800 ppm n-octane

Benzene 10 - 250 ppm

Order No. 64 06 280

Measuring Range:	10 to 250 ppm (20 °C, 50% r.h.)
Measuring Time:	approx. 40 to 275 s
Rel. Standard deviation:	± 18%
Ambient Operating Conditions	
Temperature:	0 to 40 °C
Humidity:	1 to 30 mg/L (corresp. 2 to 60% r.h. at 40 °C)
Air Pressure:	700 to 1100hPa
Cross Sensivity	
No influence at 10 ppm benzene by	
	≤ 50 ppm toluene
	≤ 50 ppm xylene
	≤ 1000 ppm n-octane

Butadiene 1 - 25 ppm

Order No. 64 06 460

Measuring Range:	1 to 25 ppm (20 °C, 50% r.h.)
Measuring Time:	approx. 90 to 550 s
Rel. Standard deviation:	± 10%
Ambient Operating Conditions	
Temperature:	0 to 40 °C
Humidity:	1 to 30 mg/L (corresp. 2 to 60% r.h. at 40 °C)
Air Pressure:	700 to 1100hPa
Cross Sensivity	
Substance	Display of Analyzer indicates
20 ppm styrene	approx. 6 ppm
5 ppm 1-butene	approx. 1 ppm
5 ppm chloroprene	approx. 10 ppm
5 ppm propene	approx. 2 ppm

Carbon Dioxide 200 - 3000 ppm

Order No. 64 06 190

B

Measuring Range:	200 to 3000 ppm (20 °C, 50% r.h.)
Measuring Time:	approx. 60 to 260 s
Rel. Standard deviation:	± 10%
Ambient Operating Conditions	
Temperature:	0 to 40 °C
Humidity:	1 to 30 mg/L (corresp. 2 to 60% r.h. at 40 °C)
Air Pressure:	700 to 1100hPa
Cross Sensivity	
No influence at 200 ppm CO ₂ by	≤ 1 ppm hydrogen sulfide ≤ 0.2 ppm sulfur dioxide

Carbon Dioxide 1000 - 25000 ppm

Order No. 64 06 070

Measuring Range:	1000 to 25000 ppm (20 °C, 50% r.h.)
Measuring Time:	approx. 25 to 140 s
Rel. Standard deviation:	± 7%
Ambient Operating Conditions	
Temperature:	0 to 30 °C
Humidity:	1 to 30 mg/L (corresp. 3 to 98% r.h. at 30 °C)
Air Pressure:	700 to 1100hPa
Cross Sensivity	
No influence at 5000 ppm CO ₂ by	≤ 10 ppm hydrogen sulfide ≤ 2 ppm sulfur dioxide

Carbon Dioxide 1 - 20 Vol%

Order No. 64 06 210

Measuring Range:	1 to 20 Vol% (20 °C, 50% r.h.)
Measuring Time:	approx. 12 to 120 s
Rel. Standard deviation:	± 10%
Ambient Operating Conditions	
Temperature:	0 to 40 °C
Humidity:	1 to 30 mg/L (corresp. 2 to 60% r.h. at 40 °C)
Air Pressure:	700 to 1100hPa
Cross Sensivity	
No influence at 1 Vol% CO ₂ by	≤ 100 ppm hydrogen sulfide ≤ 100 ppm sulfur dioxide

Carbon Monoxide 5 - 150 ppm

Order No. 64 06 080

Measuring Range:	5 to 150 ppm (20 °C, 50% r.h.)
Measuring Time:	approx. 80 to 300 s
Rel. Standard deviation:	± 10%
Ambient Operating Conditions	
Temperature:	0 to 40 °C
Humidity:	1 to 50 mg/L (corresp. 2 to 98% r.h. at 40 °C)
Air Pressure:	700 to 1100hPa
Cross Sensivity	
No influence at 25 ppm CO by	
≤ 1000 ppm butane	≤ 300 ppm hydrogen sulfide
≤ 1000 ppm propane	≤ 100 ppm sulfur dioxide
≤ 500 ppm n-octane	≤ 15 ppm nitrogen dioxide

Chlorine 0.2 - 10 ppm

Order No. 64 06 010



Measuring Range:	0.2 to 10 ppm (20 °C, 50% r.h.)
Measuring Time:	approx. 30 to 400 s
Rel. Standard deviation:	± 12%
Ambient Operating Conditions	
Temperature:	0 to 40 °C
Humidity:	5 to 12 mg/L (corresp. 30 to 70% r.h. at 20 °C)
Air Pressure:	700 to 1100hPa
Cross Sensivity	
No influence at 0.5 ppm chlorine by	
	≤ 10 ppm hydrochloric acid

Ethanol 100 - 2500 ppm

Order No. 64 06 370

Measuring Range:	100 to 2500 ppm (20 °C, 50% r.h.)
Measuring Time:	approx. 60 to 340 s
Rel. Standard deviation:	± 14%
Ambient Operating Conditions	
Temperature:	10 to 30 °C
Humidity:	5 to 25 mg/L (corresp. 16 to 82% r.h. at 30 °C)
Air Pressure:	700 to 1100hPa
Cross Sensivity	
Substance	Display of Analyzer indicates
250 ppm methanol	approx. 225 ppm
500 ppm methanol	approx. 450 ppm
200 ppm n-butanol	approx. 150 ppm
100 ppm i-propanol	approx. 100 ppm

Ethylene Oxide 0.4 - 5 ppm

Order No. 64 06 580

Measuring Range:	0.4 to 5 ppm (20°C, 50% r.h.)
Measuring Time:	approx. 160 to 600s
Rel. Standard deviation:	± 25%
Ambient Operating Conditions	
Temperature:	10 to 30 °C
Humidity:	3 to 25 mg/L (corresp. 10 to 83% r.h. at 30 °C)
Air Pressure:	700 to 1100hPa
Cross Sensivity	
Other organic substances are likewise indicated, however, with differing sensitivity.	

Formaldehyde 0.2 - 5 ppm

Order No. 64 06 540

Measuring Range:	0.2 to 5 ppm (20 °C, 50% r.h.)
Measuring Time:	approx. 100 to 600 s
Rel. Standard deviation:	± 30% (0.2 to 0.9 ppm) ± 20% (1.0 to 5.0 ppm)

Ambient Operating Conditions

Temperature:	10 to 30 °C
Humidity:	2 to 12 mg/L (corresp. 10 to 70% r.h. at 20 °C)
Air Pressure:	700 to 1100hPa

Cross Sensivity

No intiuence by	≤ 5 ppm NO ₂
(at 1 ppm HCHO)	≤ 5 ppm HCl

Following substances are not indicated: 0.5 ppm acrolein, 500 ppm octane, 20 ppm styrene, 10 ppm vinyl acetate. Acetaldehyde is indicated with approx. the factor 8 less than fomaldehyde.

Hydrochloric Acid 1 - 25 ppm

Order No. 64 06 090

Measuring Range:	1 to 25 ppm (20 °C, 50% r.h.)
Measuring Time:	approx. 15 to 110 s
Rel. Standard deviation:	± 10%

Ambient Operating Conditions

Temperature:	0 to 40 °C
Humidity:	1 to 10 mg/L (corresp. 5 to 60% r.h. at 20 °C)
Air Pressure:	700 to 1100hPa

Cross Sensivity

No influence at 5 ppm HCl by	≤ 10 ppm hydrogen sulfide
	≤ 2 ppm sulfur dioxide

Hydrochloric Acid 20 - 500 ppm

Order No. 64 06 140

Measuring Range:	20 to 500 ppm (20 °C, 50% r.h.)
Measuring Time:	approx. 6 to 80 s
Rel. Standard deviation:	± 8%
Ambient Operating Conditions	
Temperature:	0 to 40 °C
Humidity:	1 to 10 mg/L (corresp. 5 to 60% r.h. at 20 °C)
Air Pressure:	700 to 1100hPa
Cross Sensivity	
No influence at 20 ppm HCl by	<ul style="list-style-type: none"> ≤ 100 ppm hydrogen sulfide ≤ 20 ppm sulfur dioxide

Hydrocyanic Acid 2 - 50 ppm

Order No. 64 06 100

Measuring Range:	2 to 50 ppm (20 °C, 50% r.h.)
Measuring Time:	approx. 30 to 260 s
Rel. Standard deviation:	± 16%
Ambient Operating Conditions	
Temperature:	0 to 30 °C
Humidity:	1 to 20 mg/L (corresp. 3 to 65% r.h. at 30 °C)
Air Pressure:	700 to 1100hPa
Cross Sensivity	
No influence at 10 ppm HCN by	<ul style="list-style-type: none"> ≤ 80 ppm hydrogen sulfide ≤ 200 ppm ammonia ≤ 50 ppm sulfur dioxide ≤ 200 ppm hydrochloric acid

Hydrogen Peroxide 0.2 - 2 ppm

Order No. 64 06 440

Measuring Range:	0.2 to 2 ppm (20 °C, 50% r.h.)
Measuring Time:	approx. 180 to 600 s
Rel. Standard deviation:	± 30%
Ambient Operating Conditions	
Temperature:	10 to 30 °C
Humidity:	1 to 20 mg/L (corresp. 3 to 65% r.h. at 30 °C)
Air Pressure:	700 to 1100hPa
Cross Sensivity	
Substances	Display of Analyzer indicates
0.1 ppm ozone	approx. 0.3 ppm
0.5 ppm ozone	approx. 2 ppm
0.5 ppm chlorine	approx. > 2 ppm

Hydrogen Sulfide 0.2 - 5 ppm

Order No. 64 06 520

F

Measuring Range:	0.2 to 5 ppm (20 °C, 50% r.h.)
Measuring Time:	approx. 40 to 450 s
Rel. Standard deviation:	± 25%
Ambient Operating Conditions	
Temperature:	0 to 40 °C
Humidity:	1 to 30 mg/L (corresp. 2 to 60% r.h. at 40 °C)
Air Pressure:	700 to 1100hPa
Cross Sensivity	
No influence at 0.2 ppm H ₂ S by	<ul style="list-style-type: none"> ≤ 5 ppm nitrogen dioxide ≤ 2 ppm sulfur dioxide
Mercaptan is also indicated, but with different sensitivity.	

Hydrogen Sulfide 2 - 50 ppm

Order No. 64 06 050

Measuring Range:	2 to 50 ppm (20 °C, 50% r.h.)
Measuring Time:	approx. 20 to 200 s
Rel. Standard deviation:	± 7%
Ambient Operating Conditions	
Temperature:	0 to 40 °C
Humidity:	1 to 40 mg/L (corresp. 2 to 80% r.h. at 40 °C)
Air Pressure:	700 to 1100hPa
Cross Sensivity	
No influence at 10 ppm H ₂ S by	<ul style="list-style-type: none"> ≤ 50 ppm nitrogen dioxide ≤ 20 ppm sulfur dioxide ≤ 200 ppm mercaptan

Hydrogen Sulfide 20 - 500 ppm

Order No. 64 06 150

Measuring Range:	20 to 500 ppm (20 °C, 50% r.h.)
Measuring Time:	approx. 30 to 240 s
Rel. Standard deviation:	± 13%
Ambient Operating Conditions	
Temperature:	0 to 40 °C
Humidity:	1 to 40 mg/L (corresp. 2 to 80% r.h. at 40 °C)
Air Pressure:	700 to 1100hPa
Cross Sensivity	
No influence at 100 ppm H ₂ S by	<ul style="list-style-type: none"> ≤ 50 ppm nitrogen dioxide ≤ 20 ppm sulfur dioxide ≤ 200 ppm mercaptan

Hydrogen Sulfide 100 - 2500 ppm

Order No. 64 06 220

Measuring Range:	100 to 2500 ppm (20 °C, 50% r.h.)
Measuring Time:	approx. 40 to 500 s
Rel. Standard deviation:	± 9%
Ambient Operating Conditions	
Temperature:	0 to 40 °C
Humidity:	1 to 40 mg/L (corresp. 2 to 80% r.h. at 40 °C)
Air Pressure:	700 to 1100hPa
Cross Sensivity	
No influence at 100 ppm H ₂ S by	<ul style="list-style-type: none"> ≤ 10 ppm nitrogen dioxide ≤ 25 ppm sulfur dioxide ≤ 300 ppm mercaptan

Mercaptan 0.25 - 6 ppm

Order No. 64 06 360

H

Measuring Range:	0.25 to 6 ppm (20 °C, 50% r.h.)
Measuring Time:	approx. 70 to 480 s
Rel. Standard deviation:	± 15%
Ambient Operating Conditions	
Temperature:	0 to 40 °C
Humidity:	1 to 30 mg/L (corresp. 2 to 60% r.h. at 40 °C)
Air Pressure:	700 to 1100hPa
Cross Sensivity	
No influence at 1 ppm mercaptan by	<ul style="list-style-type: none"> ≤ 10 ppm hydrogen sulfide

Methanol 20 - 500 ppm

Order No. 64 06 380

Measuring Range:	20 to 500 ppm (20 °C, 50% r.h.)
Measuring Time:	approx. 200 to 600 s
Rel. Standard deviation:	± 19%
Ambient Operating Conditions	
Temperature:	15 to 30 °C
Humidity:	5 to 25 mg/L (corresp. 16 to 82% r.h. at 30 °C)
Air Pressure:	700 to 1100hPa
Cross Sensivity	
Substance	Display of Analyzer indicates
250 ppm i-propanol	approx. 350 ppm
250 ppm ethanol	approx. 380 ppm
100 ppm n-butanol	approx. 75 ppm

Methylene Chloride 20 - 400 ppm

Order No. 64 06 510

Measuring Range:	20 to 400 ppm (20 °C, 50% r.h.)
Measuring Time:	approx. 180 to 600 s
Rel. Standard deviation:	± 25%
Ambient Operating Conditions	
Temperature:	10 to 40 °C
Humidity:	1 to 30 mg/L (corresp. 2 to 60% r.h. at 40 °C)
Air Pressure:	700 to 1100hPa
Cross Sensivity	
No influence by	≤ 5 ppm HCl
(at 20 ppm CH ₂ Cl ₂)	≤ 0,1 ppm Cl ₂
	≤ 1 Vol% CO ₂
It is impossible to measure methylene chloride in the presence of other chlorinated hydrocarbons	

MTBE (tert butyl methyl ether) 10 - 200 ppm

Order No. 64 06 530

Measuring Range:	10 to 200 ppm (20 °C, 50% r.h.)
Measuring Time:	approx. 90 to 450 s
Rel. Standard deviation:	± 15%
Ambient Operating Conditions	
Temperature:	10 to 30 °C
Humidity:	1 to 30 mg/L (corresp. 3 to 98% r.h. at 30 °C)
Air Pressure:	700 to 1100hPa
Cross Sensivity	
Aromatics and petroleum hydrocarbons are also indicated, however, with different sensitivities.	

Nitrogen Dioxide 0.5 - 25 ppm

Order No. 64 06 120

M

Measuring Range:	0.5 to 25 ppm (20 °C, 50% r.h.)
Measuring Time:	approx. 20 to 330 s
Rel. Standard deviation:	± 8%
Ambient Operating Conditions	
Temperature:	0 to 40 °C
Humidity:	1 to 30 mg/L (corresp. 3 to 98% r.h. at 30 °C)
Air Pressure:	700 to 1100hPa
Cross Sensivity	
No influence at 3 ppm NO ₂ by	
	≤ 0.1 ppm ozone
	≤ 50 ppm sulfur dioxide
Chlorine is indicated with differing sensitivity. Nitrogen monoxide is not indicated.	

Nitrous Fumes 0.5 - 15 ppm

Order No. 64 06 060

Measuring Range:	0.5 to 15 ppm (20 °C, 50% r.h.)
Measuring Time:	approx. 40 to 350 s
Rel. Standard deviation:	± 11%
Ambient Operating Conditions	
Temperature:	0 to 40 °C
Humidity:	1 to 40 mg/L (corresp. 2 to 80% r.h. at 40 °C)
Air Pressure:	700 to 1100hPa
Cross Sensivity	
No influence at 3 ppm NO _x by	<ul style="list-style-type: none"> ≤ 0.1 ppm ozone ≤ 50 ppm sulfur dioxide
Chlorine is indicated with differing sensitivity.	

Nitrous Fumes 10 - 200 ppm

Order No. 64 06 240

Measuring Range:	10 to 200 ppm (20 °C, 50% r.h.)
Measuring Time:	approx. 20 to 100 s
Rel. Standard deviation:	± 12%
Ambient Operating Conditions	
Temperature:	0 to 40 °C
Humidity:	1 to 30 mg/L (corresp. 2 to 60% r.h. at 40 °C)
Air Pressure:	700 to 1100hPa
Cross Sensivity	
No influence at 20 ppm NO _x by	<ul style="list-style-type: none"> ≤ 0.2 ppm ozone ≤ 50 ppm sulfur dioxide
Chlorine is indicated with differing sensitivity.	

Oxygen 1 - 30 Vol%

Order No. 64 06 490

Measuring Range:	1 to 30 Vol% (20 °C, 50% r.h.)
Measuring Time:	approx. 100 to 600 s
Rel. Standard deviation:	± 18%
Ambient Operating Conditions	
Temperature:	1 to 40 °C
Humidity:	1 to 40 mg/L (corresp. 2 to 80% r.h. at 40 °C)
Air Pressure:	700 to 1100hPa
Cross Sensivity	
No influence at 1 Vol% O ₂ by	< 60 ppm CO < 0.5 Vol% CO ₂ < 200 ppm xylene < 100 ppm tri- and perchloroethylene < 1000 ppm acetone < 850 ppm ethyl acetate

Ozone 25 - 1000 ppb

Order No. 64 06 430

Measuring Range:	25 to 1000 ppb (20 °C, 50% r.h.)
Measuring Time:	approx. 100 to 600 s
Rel. Standard deviation:	± 20%
Ambient Operating Conditions	
Temperature:	0 to 40 °C
Humidity:	1 to 25 mg/L (corresp. 2 to 50% r.h. at 40 °C)
Air Pressure:	700 to 1100hPa
Cross Sensivity	
Substance	Display of Analyzer indicates
0.2 ppm hydrogen peroxide	approx. 50 ppb
1.0 ppm hydrogen peroxide	approx. 250 ppb
0.5 ppm chlorine	approx. 500 ppb
2.5 ppm chlorine	> 1000 ppb

Perchloroethylene 5 - 500 ppm

Order No. 64 06 040

Measuring Range:	5 to 500 ppm (20 °C, 50% r.h.)
Measuring Time:	approx. 40 to 330 s
Rel. Standard deviation:	± 25% at 5 ppm ± 12% at 10 to 500 ppm
Ambient Operating Conditions	
Temperature:	15 to 40 °C
Humidity:	5 to 30 mg/L (corresp. 10 to 60% r.h. at 40 °C)
Air Pressure:	700 to 1100hPa
Cross Sensivity	
No influence at 5 ppm perchloroethylene by	≤ 10 ppm n-octane

Petroleum Hydrocarbons

20 - 500 ppm

Order No. 64 06 200

Measuring Range:	20 to 500 ppm n-octane (20 °C, 50% r.h.)
Measuring Time:	approx. 150 to 330 s
Rel. Standard deviation:	± 15%
Ambient Operating Conditions	
Temperature:	0 to 40 °C
Humidity:	1 to 30 mg/L (corresp. 2 to 60% r.h. at 40 °C)
Air Pressure:	700 to 1100hPa
Cross Sensivity	
Substance	Display of Analyzer indicates
250 ppm n-hexane	approx. 330 ppm
250 ppm n-heptane	approx. 280 ppm
250 ppm n-nonane	approx. 150 ppm
200 ppm toluene	approx. 80 ppm
50 ppm o-xylene	< 20 ppm

Petroleum Hydrocarbons

100 - 3000 ppm

Order No. 64 06 270

Measuring Range:	100 to 3000 ppm n-octane (20 °C, 50% r.h.)
Measuring Time:	approx. 30 to 110 s
Rel. Standard deviation:	± 13%
Ambient Operating Conditions	
Temperature:	0 to 40 °C
Humidity:	1 to 30 mg/L (corresp. 2 to 60% r.h. at 40 °C)
Air Pressure:	700 to 1100hPa
Cross Sensivity	
Substance	Display of Analyzer indicates
250 ppm n-hexane	approx. 330 ppm
250 ppm n-heptane	approx. 280 ppm
250 ppm n-nonane	approx. 150 ppm
200 ppm toluene	< 100 ppm
200 ppm o-xylene	< 100 ppm

Phosgene 0.05 - 2 ppm

Order No. 64 06 340

Measuring Range:	0.05 to 2 ppm (20 °C, 50% r.h.)
Measuring Time:	approx. 90 to 420 s
Rel. Standard deviation:	± 12%
Ambient Operating Conditions	
Temperature:	0 to 40 °C
Humidity:	1 to 30 mg/L (corresp. 2 to 60% r.h. at 40 °C)
Air Pressure:	700 to 1100hPa
Cross Sensivity	
No influence at 0.05 ppm COCl ₂ by	≤ 100 ppm methyl chloride
	≤ 10 ppm hydrochloric acid
	≤ 100 ppm carbon monoxide



Phosphine 0.1 - 2.5 ppm

Order No. 64 06 400

Measuring Range:	0.1 to 2.5 ppm (20 °C, 50% r.h.)
Measuring Time:	approx. 25 to 350 s
Rel. Standard deviation:	± 14%
Ambient Operating Conditions	
Temperature:	0 to 40 °C
Humidity:	1 to 30 mg/L (corresp. 2 to 60% r.h. at 40 °C)
Air Pressure:	700 to 1100hPa
Cross Sensivity	
No influence at 1 ppm PH ₃ by	≤ 10 ppm methyl bromide

Phosphine 1 - 25 ppm

Order No. 64 06 410

Measuring Range:	1 to 25 ppm (20 °C, 50% r.h.)
Measuring Time:	approx. 50 to 600 s
Rel. Standard deviation:	± 14%
Ambient Operating Conditions	
Temperature:	0 to 40 °C
Humidity:	1 to 30 mg/L (corresp. 2 to 60% r.h. at 40 °C)
Air Pressure:	700 to 1100hPa
Cross Sensivity	
No influence at 1 ppm PH ₃ by	≤ 10 ppm methyl bromide

Phosphine 20 - 500 ppm

Order No. 64 06 420

Measuring Range:	20 to 500 ppm (20 °C, 50% r.h.)
Measuring Time:	approx. 25 to 220 s
Rel. Standard deviation:	± 10%
Ambient Operating Conditions	
Temperature:	0 to 40 °C
Humidity:	1 to 30 mg/L (corresp. 2 to 60% r.h. at 40 °C)
Air Pressure:	700 to 1100hPa
Cross Sensivity	
No influence at 20 ppm PH ₃ by	≤ 50 ppm methyl bromide.

Phosphine 200 - 5000 ppm

Order No. 64 06 500

P

Measuring Range:	200 to 5000 ppm (20 °C, 50% r.h.)
Measuring Time:	approx. 20 to 200 s
Rel. Standard deviation:	± 10%
Ambient Operating Conditions	
Temperature:	0 to 40 °C
Humidity:	1 to 30 mg/L (corresp. 2 to 60% r.h. at 40 °C)
Air Pressure:	700 to 1100hPa
Cross Sensivity	
No influence at 200 ppm PH ₃ by	< 50 ppm methyl bromide

Propane 100 - 2000 ppm

Order No. 64 06 310

Measuring Range:	100 to 2000 ppm (20 °C, 50% r.h.)
Measuring Time:	approx. 60 to 360 s
Rel. Standard deviation:	± 10%
Ambient Operating Conditions	
Temperature:	0 to 40 °C
Humidity:	1 to 40 mg/L (corresp. 2 to 80% r.h. at 40 °C)
Air Pressure:	700 to 1100hPa
Cross Sensivity	
No influence at 100 ppm propane by	<ul style="list-style-type: none"> ≤ 2000 ppm methane ≤ 2000 ppm ethane
Other aliphatic hydrocarbons are also indicated, however, with differing sensitivity.	

i-Propanol 40 - 1000 ppm

Order No. 64 06 390

Measuring Range:	40 to 1000 ppm (20 °C, 50% r.h.)
Measuring Time:	approx. 100 to 550 s
Rel. Standard deviation:	± 16%
Ambient Operating Conditions	
Temperature:	10 to 30 °C
Humidity:	5 to 25 mg/L (corresp. 16 to 82% r.h. at 30 °C)
Air Pressure:	700 to 1100hPa
Cross Sensivity	
Substance	Display of Analyzer indicate
250 ppm ethanol	approx. 275 ppm
100 ppm methanol	approx. 120 ppm
100 ppm n-butanol	approx. 80 ppm

Styrene 2 - 40 ppm

Order No. 64 06 560

Measuring Range:	2 to 40 ppm (20 °C, 50% r.h.)
Measuring Time:	approx. 100 to 550 s
Rel. Standard deviation:	± 19%
Ambient Operating Conditions	
Temperature:	5 to 40 °C
Humidity:	5 to 30 mg/L (corresp. 10 to 60% r.h. at 40 °C)
Air Pressure:	700 to 1100hPa
Cross Sensivity	
100 ppm n-octane, 50 ppm toluene, 50 ppm o-xylene, 50 ppm methanol and 50 ppm ethyl acetate are not indicated.	

Sulfur Dioxide 0.4 - 10 ppm

Order No. 64 06 110

P

Measuring Range:	0.4 to 10 ppm (20 °C, 50% r.h.)
Measuring Time:	approx. 40 to 300 s
Rel. Standard deviation:	± 18%
Ambient Operating Conditions	
Temperature:	5 to 30 °C
Humidity:	5 to 20 mg/L (corresp. 15 to 65% r.h. at 30 °C)
Air Pressure:	700 to 1100hPa
Cross Sensivity	
No influence at 0.4 ppm SO ₂ by	≤ 150 ppm hydrogen sulfide ≤ 10 ppm hydrochloric acid

Sulfur Dioxide 5 - 150 ppm

Order No. 64 06 180

Measuring Range:	5 to 150 ppm (20 °C, 50% r.h.)
Measuring Time:	approx. 40 to 360 s
Rel. Standard deviation:	± 12%
Ambient Operating Conditions	
Temperature:	5 to 40 °C
Humidity:	1 to 40 mg/L (corresp. 2 to 80% r.h. at 40 °C)
Air Pressure:	700 to 1100hPa
Cross Sensivity	
No influence at 5 ppm SO ₂ by	≤ 150 ppm hydrogen sulfide ≤ 10 ppm hydrochloric acid

Toluene 10 - 300 ppm

Order No. 64 06 250

Measuring Range:	10 to 300 ppm (20 °C, 50% r.h.)
Measuring Time:	approx. 30 to 380 s
Rel. Standard deviation:	± 19%
Ambient Operating Conditions	
Temperature:	0 to 40 °C
Humidity:	1 to 30 mg/L (corresp. 2 to 60% r.h. at 40 °C)
Air Pressure:	700 to 1100hPa
Cross Sensivity	
Substance	Display of Analyzer indicates
300 ppm n-octane	< 10 ppm
10 ppm o-xylene	< 10 ppm
100 ppm o-xylene	approx. 70 ppm
100 ppm benzene	approx. ≥ 120 ppm

Trichloroethylene 5 - 100 ppm

Order No. 64 06 320

Measuring Range:	5 to 100 ppm (20 °C, 50% r.h.)
Measuring Time:	approx. 40 to 330 s
Rel. Standard deviation:	± 10%
Ambient Operating Conditions	
Temperature:	0 to 40 °C
Humidity:	1 to 30 mg/L (corresp. 2 to 60% r.h. at 40 °C)
Air Pressure:	700 to 1100hPa
Cross Sensivity	
Substance	Display of Analyzer indicates
No influence at 5 ppm trichloroethylene by	
	≤ 10 ppm n-octane
	≤ 2 ppm hydrochloric acid
Chlorine is indicated with identical sensitivity.	

Vinyl chloride 0.3 - 10 ppm

Order No. 64 06 170

Measuring Range:	0.3 to 10 ppm (20 °C, 50% r.h.)
Measuring Time:	approx. 30 to 420 s
Rel. Standard deviation:	± 18%
Ambient Operating Conditions	
Temperature:	0 to 40 °C
Humidity:	1 to 30 mg/L (corresp. 2 to 60% r.h. at 40 °C)
Air Pressure:	700 to 1100hPa
Cross Sensivity	
No influence at 0.3 ppm vinyl chloride by	
	≤ 20 ppm hydrochloric acid
	≤ 5 ppm chlorine
	≤ 0.5 ppm trichloroethylene

Vinyl chloride 10 - 250 ppm

Order No. 64 06 230

Measuring Range:	10 to 250 ppm (20 °C, 50% r.h.)
Measuring Time:	approx. 45 to 100 s
Rel. Standard deviation:	± 12%
Ambient Operating Conditions	
Temperature:	0 to 40 °C
Humidity:	1 to 30 mg/L (corresp. 2 to 60% r.h. at 40 °C)
Air Pressure:	700 to 1100hPa
Cross Sensivity	
No influence at 10 ppm vinyl chloride by	
	≤ 50 ppm hydrochloric acid
	≤ 25 ppm chlorine
	≤ 2 ppm trichloroethylene

Water Vapor 0.4 - 10 mg/L

Order No. 64 06 450

Measuring Range:	0.4 to 10 mg/L (20 °C, 50% r.h.)
Measuring Time:	approx. 20 to 120 s
Rel. Standard deviation:	± 10%
Ambient Operating Conditions	
Temperature:	0 to 40 °C
Air Pressure:	700 to 1100hPa
Cross Sensivity	
Acid and basic gases cause plus errors.	

o-Xylene 10 - 300 ppm

Order No. 64 06 260

Measuring Range:	10 to 300 ppm (20 °C, 50% r.h.)
Measuring Time:	approx. 75 to 500 s
Rel. Standard deviation:	± 19%
Ambient Operating Conditions	
Temperature:	0 to 40 °C
Humidity:	1 to 30 mg/L (corresp. 2 to 60% r.h. at 40 °C)
Air Pressure:	700 to 1100hPa
Cross Sensivity	
Substance	Display of Analyzer indicates
300 ppm n-octane	< 10 ppm
100 ppm m-xylene	approx. 120 ppm
100 ppm p-xylene	approx. 140 ppm
100 ppm toluene	approx. 130 ppm
100 ppm benzene	approx. 150 ppm

Training Chip

Order No. 64 06 290

Measuring Range:	not applicable (20 °C, 50% r.h.)
Measuring Time:	approx. 30 s
Rel. Standard deviation:	not applicable
Ambient Operating Conditions	
Temperature:	0 to 40 °C
Humidity:	1 to 40 mg/L (corresp. 5 to 100% r.h. at 40 °C)
Air Pressure:	700 to 1100hPa
Cross Sensivity	not applicable

5.3 Physical, Chemical, and Toxicological Data for selected Substances

5.3.1 Explanation to the Physical, Chemical, and Toxicological Data

The table lists physical, chemical and toxicological data for many of the airborne contaminants that can be measured using direct reading Dräger detector tubes or Dräger-Chips. This table is intended to serve as a convenient reference source. The information was compiled from relevant technical publications, however, Dräger is not responsible for any use or misuse of the information. The given data, especially the threshold limit values, are current as of AGW-Value: November 2014; TLV-Value: November 2014; WEL-Value: November 2014.

Chemical Name

The common names are given in alphabetical order.

CAS-Number

The CAS-Number is an identification number of the **C**hemical **A**bstract **S**ervice (CAS).

Chemical Formula

The format is molecular, showing the actual number and kind of atoms.

Molecular Weight

The molecular weight listed in the table is given as Kg/Kmol.

Limit Values

The limit values listed for the gases, vapors and aerosols in the table are given in units of ml/m³ (ppm) or mg/m³. The ml/m³ units are given independent of temperature and pressure, but the mg/m³ values are based on 20 °C and 1013 hPa (mbar).

German **AGW-values**¹⁾: In addition to the 8-hour average of the 40-hour workweek the limitation of the peak exposure (peak limit / factor of exceeding) is given in line with the TRGS 900. In case that in the TRGS 900 no values are published then the values of the DFG list are used (Note "DFG" is used).

With 1) marked values:

Workplace limit values corresponding to the proposed tolerable cancer risk. (see TRGS 900)

With 2) marked values:

Workplace limit values corresponding to the proposed preliminary acceptable cancer risk.

The workplace exposure limits of the USA are the TLV values (Threshold Limit Values). The values of the NIOSH list are used. In case that in the NIOSH list no values are published then the values of the OSHA list are used (Note "OSHA" is used).

The WEL-values are the valid Workplace Exposure Limits of UK.

[WEL-Values in brackets]:

The UK Advisory Committee on Toxic Substances has expressed concern that, for the OELs shown in parentheses, health may not be adequately protected because of doubts that the limit was not soundly-based. These OELs were included in the published UK 2002 list and its 2003 supplement, but are omitted from the published 2005 list.

For both limit values the TWA-value (Time-Weighted Average) and the STEL-value (Short-Term Exposure Limit) have approximately the same meaning as the AGW average value and the AGW peak exposure.

Conversion Factors

These factors provide for quick conversion from ml/m^3 (ppm) to mg/m^3 and mg/m^3 to ml/m^3 .

Vapor Pressure

The pressure at any given temperature of a vapor in equilibrium with its liquid or solid state. The data in the table relates to 20 °C and is given in hPa (mbar).

Relative Vapor Density

The relative vapor density is the relationship of the weight of the vapor to air (air = 1).

Melting Point

The melting point is given in °C at 1013 hPa (mbar).

Boiling Point

The boiling point is given in °C at 1013 hPa (mbar). If the substance sublimates, the abbreviation "subl." is given. If the substance decomposes, the abbreviation "decom." is given.

UN-Number

This is a four digit international identification number assigned to a substance or substance group by the United Nations for the transportation of dangerous goods.

Group and Hazard Class (VbF)

The groups and hazard classes are in accordance with the "Verordnung über brennbare Flüssigkeiten-VbF" (Regulations on flammable liquids).

1. Group A:

Liquids which have a flash point which do not exceed 100 °C and which do not have the properties of Group B with regard to water solubility.

Hazard Class I:

Liquids with a flash point below 21 °C.

Hazard Class II:

Liquids with a flash point between 21 °C and 55 °C.

Hazard Class III:

Liquids with a flash point between 55 °C and 100 °C.

2. Group B:

Liquids with a flash point below 21 °C, which dissolve in water in any arbitrary ratio at 15 °C or the flammable liquid components of which dissolve in water in any ratio at 15 °C.

Ignition Temperature

The ignition temperature is the lowest temperature at which a flammable gas/air or vapor/air mixture will just ignite. The temperature is given in °C at 1013 hPa (mbar).

Lower Ignition Limit and Upper Ignition Limit

Flammable gases or vapors, mixed with air, are explosive within a given concentration range. In this table, the concentration range is given in percent by volume of the gas or vapor, mixed with air, in which ignition by an external ignition source is possible. The values are given at 20 °C and 1013 hPa (mbar).

Smelling Point

The smelling point concentration is given from informations out of different literature and deviates sometimes. The concentrations in this table should be for orientation only.

Note

A dash signifies the information is not known or unavailable, it does not denote a zero.

5.3.2 Table of Physical, Chemical, and Toxicological Data for selected Substances

		Acetaldehyde	Acetic Acid	Acetone	Acetylene
CAS – Number		[75-07-0]	[64-19-7]	[67-64-1]	[74-86-2]
Chemical Formula		H ₃ C-CHO	H ₃ C-COOH	H ₃ C-CO-CH ₃	C ₂ H ₂
Molecular Weight [Kg/Kmol]		44.05	60.05	58.08	26.04
AGW-Value	ppm = [mL/m ³]	50	10	500	–
	[mg/m ³]	91	25	1200	–
Peak Limit	[ppm]	50 (15 min) 100 (peak)	20 (15 min)	1000 (15 min)	–
TLV-Value					
TWA	ppm = [mL/m ³]	18 (LOQ)	10	250	–
	[mg/m ³]	–	25	590	–
STEL	ppm = [mL/m ³]	200 (OSHA)	15 (15 min)	–	2500 (15 min)
	[mg/m ³]	360 (OSHA)	37 (15 min)	–	2662 (15 min)
WEL-Value					
TWA	ppm = [mL/m ³]	20	[10]	500	–
	[mg/m ³]	37	[25]	1210	–
STEL	ppm = [mL/m ³]	50	[15]	1500	–
	[mg/m ³]	92	[37]	3620	–
Conversion Factors					
1 ppm = 1 mL/m ³ = [mg/m ³]		1.83	2.5	2.41	1.08
[1 mg/m ³] = ppm = mL/m ³		0.55	0.40	0.41	0.92
Vapor Pressure at 20°C [h Pa]		1006	15.8	246	42473
Relative Vapor Density		1.52	2.07	2.00	0.91
Melting Point [°C]		-123	17	-95	-80.8
Boiling Point [°C]		20	118	56	-83.8 subl.
UN – Number		1089	2789	1090	1001
Group & Hazard Class		B	–	B	–
Ignition Temperature [°C]		155	485	535	305
Lower Ignition Limit [Vol%]		4	6	2.5	2.3
Upper Ignition Limit [Vol%]		57	17	14.3	100
Odor threshold (approx.) ppm		0.2	1	100	670 mg/m ³

		Acrolein	Acrylonitrile	Alcohol (Ethanol)	Ammonia
CAS – Number		[107-02-8]	[107-13-1]	[64-17-5]	[7664-41-7]
Chemical Formula		H ₂ C=CH-CHO	H ₂ C=CH-CN	H ₃ C-CH ₂ OH	NH ₃
Molecular Weight [Kg/Kmol]		56.06	53.06	46.07	17.03
AGW-Value	ppm = [mL/m ³]	0.09	1.2 ¹⁾ 0.12 ²⁾	500	20
	[mg/m ³]	0.2	2.64 ¹⁾ 0.26 ²⁾	960	14
Peak Limit	[ppm]	0.18 (15 min)	9.6 ¹⁾ (15 min)	1000 (15 min)	40 (15 min)
TLV-Value					
TWA	ppm = [mL/m ³]	0.1	1	1000	25
	[mg/m ³]	0.25	–	1900	18
STEL	ppm = [mL/m ³]	0.3 (15 min)	10 (NIOSH)	–	35
	[mg/m ³]	0.8 (15 min)	–	–	27
WEL-Value					
TWA	ppm = [mL/m ³]	0.1	2	1000	25
	[mg/m ³]	0.23	4.4	1920	18
STEL	ppm = [mL/m ³]	0.3	–	–	35
	[mg/m ³]	0.7	–	–	25
Conversion Factors					
1 ppm = 1 mL/m ³ = [mg/m ³]		2.33	2.21	1.92	0.71
[1 mg/m ³] = ppm = mL/m ³		0.43	0.45	0.52	1.41
Vapor Pressure at 20°C [h Pa]		295	117	58	8574
Relative Vapor Density		1.94	1.83	1.59	0.6
Melting Point [°C]		-88	-82	-114	-77.7
Boiling Point [°C]		52	77	78	-33.4
UN – Number		1092	1093	1170	1005
Group & Hazard Class		A I	A I	B	–
Ignition Temperature [°C]		215	480	400	630
Lower Ignition Limit [Vol%]		2.8	2.8	3.1	15.4
Upper Ignition Limit [Vol%]		31	28	27.7	33.6
Odor threshold (approx.) ppm		0.1	20	10	5

		Aniline	Arsenic trioxide	Arsine	Benzene
CAS – Number		[62-53-3]	[1327-53-3]	[7784-42-1]	[71-43-2]
Chemical Formula		C ₆ H ₅ -NH ₂	As ₂ O ₃	AsH ₃	C ₆ H ₆
Molecular Weight [Kg/Kmol]		93.13	197.84	77.95	78.11
AGW-Value	ppm = [mL/m ³]	2 (15 min)	–	0.005	0.6 ¹⁾ 0.06 ²⁾
	[mg/m ³]	7.7 (15 min)	–	0.016	1.94 ¹⁾ 0.2 ²⁾
Peak Limit	[ppm]	4 (15 min)	–	0.04 (15 min)	–
TLV-Value					
TWA	ppm = [mL/m ³]	5 (OSHA)	–	0.05 (OSHA)	0.1
	[mg/m ³]	19 (OSHA)	–	0.2 (OSHA)	0.32
STEL	ppm = [mL/m ³]	–	–	–	1 ¹⁾
	[mg/m ³]	–	–	–	3.2
WEL-Value					
TWA	ppm = [mL/m ³]	1	–	0.05	1
	[mg/m ³]	4	–	0.16	–
STEL	ppm = [mL/m ³]	–	–	–	–
	[mg/m ³]	–	–	–	–
Conversion Factors					
1 ppm = 1 mL/m ³ = [mg/m ³]		3.87	8.22	3.24	3.25
[1 mg/m ³] = ppm = mL/m ³		0.26	0.12	0.31	0.31
Vapor Pressure at 20°C [h Pa]		0.681	0	16000	100
Relative Vapor Density		3.22	3.865	2.69	2.7
Melting Point [°C]		-6.0	313	-116.9	5.5
Boiling Point [°C]		184	460	-62.48	80
UN – Number		1547	1561	2188	1114
Group & Hazard Class		A III	–	–	A I
Ignition Temperature [°C]		630	–	285	555
Lower Ignition Limit [Vol%]		1.2	–	3.9	1.2
Upper Ignition Limit [Vol%]		11	–	77.8	8.6
Odor threshold (approx.) ppm		0.5	–	0.2	5

		Bromine	Bromotrifluoro- methane	1.3-Butadiene	Butane
CAS – Number		[7726-95-6]	[75-63-8]	[106-99-0]	[106-97-8]
Chemical Formula		Br ₂	CF ₃ Br	H ₂ C=CH-CH=CH ₂	H ₃ C-CH ₂ -CH ₂ -CH ₃
Molecular Weight [Kg/Kmol]		159.81	148.91	54.09	58.1
AGW-Value	ppm = [mL/m ³]	–	1000	5 ¹⁾ 0.2 ²⁾	1000
	[mg/m ³]	0.7	6200	5 ¹⁾ 0.5 ²⁾	2400
Peak Limit	[ppm]	0.7 (15min)	8000 (15 min)	–	4000 (15 min)
TLV-Value					
TWA	ppm = [mL/m ³]	0.1	1000	0.19 (LOQ)	800
	[mg/m ³]	0.7	6100	–	1900
STEL	ppm = [mL/m ³]	0.3 (15 min.)	–	–	–
	[mg/m ³]	2 (15 min)	–	–	–
WEL-Value					
TWA	ppm = [mL/m ³]	0.1	[1000]	10	600
	[mg/m ³]	0.66	[6190]	22	1450
STEL	ppm = [mL/m ³]	0.2	[1200]	–	750
	[mg/m ³]	1.3	[7430]	–	1810
Conversion Factors					
1 ppm = 1 mL/m ³ = [mg/m ³]		6.62	6.19	2.25	2.42
[1 mg/m ³] = ppm = mL/m ³		0.15	0.16	0.44	0.41
Vapor Pressure at 20°C [h Pa]		220	14347	2450	2100
Relative Vapor Density		5.52	5.23	1,93	2.08
Melting Point [°C]		-7.25	-168.0	-108.9	-138,29
Boiling Point [°C]		59.47	-58	-4.5	-0.5
UN – Number		1744	1009	1010	1011
Group & Hazard Class		–	–	–	–
Ignition Temperature [°C]		–	–	415	365
Lower Ignition Limit [Vol%]		–	–	1.4	1.4
Upper Ignition Limit [Vol%]		–	–	16.3	9.4
Odor threshold (approx.) ppm		< 0.01	–	–	1.5

		n-Butanol	Butene	Carbon dioxide	Carbon disulfide
CAS – Number		[71-36-3]	[106-98-9]	[124-38-9]	[75-15-0]
Chemical Formula		H ₃ C-(CH ₂) ₂ -CH ₂ OH	H ₂ C=CH-CH ₂ -CH ₃	CO ₂	CS ₂
Molecular Weight [Kg/Kmol]		74.12	56.1	44.01	76.14
AGW-Value	ppm = [mL/m ³]	100	–	5000	10
	[mg/m ³]	310	–	9100	30
Peak Limit	[ppm]	100 (15 min)	–	10000 (15 min)	20 (15 min)
TLV-Value					
TWA	ppm = [mL/m ³]	100 (OSHA)	–	5000	1
	[mg/m ³]	300 (OSHA)	–	9150	3
STEL	ppm = [mL/m ³]	50	–	30000 (15 min)	10 (15 min)
	[mg/m ³]	150	–	54000 (15 min)	30 (15 min)
WEL-Value					
TWA	ppm = [mL/m ³]	–	–	5000	10
	[mg/m ³]	–	–	9000	32
STEL	ppm = [mL/m ³]	50	–	15000	–
	[mg/m ³]	154	–	27400	–
Conversion Factors					
1 ppm = 1 mL/m ³ = [mg/m ³]		3.08	2.33	1.83	3.16
[1 mg/m ³] = ppm = mL/m ³		0.33	0.43	0.55	0.32
Vapor Pressure at 20°C [h Pa]		7.6	2545	57258	395
Relative Vapor Density		2.56	1.94	1.53	2.64
Melting Point [°C]		-89	-185,35	–	-112
Boiling Point [°C]		118	-6.2	-78.5 subl.	46
UN – Number		1120	1012	1013	1131
Group & Hazard Class		A II	–	–	A I
Ignition Temperature [°C]		325	360	–	95
Lower Ignition Limit [Vol%]		1.4	1.5	–	0.6
Upper Ignition Limit [Vol%]		11.3	10.6	–	60
Odor threshold (approx.) ppm		25	–	odorless	< 1

		Carbon monoxide	Carbon tetrachloride	Chlorine	Chlorine dioxide
CAS – Number		[630-08-0]	[56-23-5]	[7782-50-5]	[10049-04-4]
Chemical Formula		CO	CCl ₄	Cl ₂	ClO ₂
Molecular Weight [Kg/Kmol]		28.01	153.82	70.91	67.45
AGW-Value	ppm = [mL/m ³]	30	0.5	0.5	0.1
	[mg/m ³]	35	3.2	1.5	0.28
Peak Limit	[ppm]	60 (15 min)	1 (15 min)	0.5 (15 min)	0.1 (15 min)
TLV-Value					
TWA	ppm = [mL/m ³]	35	10 (OSHA)	–	0.1
	[mg/m ³]	40	–	–	0.3
STEL	ppm = [mL/m ³]	200	2 (60 min)	0.5	0.3 (15 min)
	[mg/m ³]	229	12.6 (60 min)	1.42	0.9 (15 min)
WEL-Value					
TWA	ppm = [mL/m ³]	30	2	–	0.1
	[mg/m ³]	35	13	–	0.28
STEL	ppm = [mL/m ³]	200	–	0.5	0.3
	[mg/m ³]	232	–	1.5	0.84
Conversion Factors					
1 ppm = 1 mL/m ³ = [mg/m ³]		1.16	6.39	2.95	2.80
[1 mg/m ³] = ppm = mL/m ³		0.86	0.16	0.34	0.36
Vapor Pressure at 20°C [h Pa]		–	119.4	6776	1400
Relative Vapor Density		0.97	5.31	2.49	2.33
Melting Point [°C]		-205.07	-23.0	-101.0	-59
Boiling Point [°C]		-191.5	76.7	-34.1	11
UN – Number		1016	1846	1017	–
Group & Hazard Class		–	–	–	–
Ignition Temperature [°C]		605	>982	–	–
Lower Ignition Limit [Vol%]		11.3	–	–	–
Upper Ignition Limit [Vol%]		75.6	–	–	–
Odor threshold (approx.) ppm		odorless	70	0.02	–

		Chlorobenzene	Chlorodifluorobromo- methane	Chlorodifluoro- methane	Chloroform
CAS – Number		[108-90-7]	[353-59-3]	[75-45-6]	[67-66-3]
Chemical Formula		C ₆ H ₅ Cl	CF ₂ ClBr	CHF ₂ Cl	CHCl ₃
Molecular Weight [Kg/Kmol]		112.56	165.36	86.47	119.38
AGW-Value	ppm = [mL/m ³]	10	–	–	0.5
	[mg/m ³]	47	–	3600	2.5
Peak Limit	[ppm]	20 (15 min)	–	–	1 (15 min)
TLV-Value					
TWA	ppm = [mL/m ³]	75 (OSHA)	–	1000	–
	[mg/m ³]	350 (OSHA)	–	3590	–
STEL	ppm = [mL/m ³]	–	–	1250 (15 min)	2 (60 min)
	[mg/m ³]	–	–	4375 (15 min)	9.78 (60 min)
WEL-Value					
TWA	ppm = [mL/m ³]	1	–	1000	2
	[mg/m ³]	–	–	3500	9.9
STEL	ppm = [mL/m ³]	3	–	–	–
	[mg/m ³]	–	–	–	–
Conversion Factors					
1 ppm = 1 mL/m ³ = [mg/m ³]		4.68	6.87	3.59	4.962
[1 mg/m ³] = ppm = mL/m ³		0.21	0.15	0.28	0.202
Vapor Pressure at 20°C [h Pa]		11.7	2294	9081	209
Relative Vapor Density		3.89	5.93	3.03	4.12
Melting Point [°C]		-45.1	-160.5	-157,3	-63
Boiling Point [°C]		132.2	-3.7	-40.9	61
UN – Number		1134	1974	1018	1888
Group & Hazard Class		A II	–	–	–
Ignition Temperature [°C]		590	–	635	982
Lower Ignition Limit [Vol%]		1.3	–	–	–
Upper Ignition Limit [Vol%]		11	–	–	–
Odor threshold (approx.) ppm		0.2	–	–	200

		Chloroprene	Chloropikrine	Chromic acid	Cyanide (as CN)
CAS – Number		[126-99-8]	[76-06-2]	[1333-82-0]	[151-50-8; 143-33-9]
Chemical Formula		H ₂ C=CCI-CH=CH ₂	CCl ₃ NO ₂	CrO ₃	KCN
Molecular Weight [Kg/Kmol]		88.54	164.38	99.99	65.12
AGW-Value	ppm = [mL/m ³]	–	0.1	–	–
	[mg/m ³]	–	0.68	–	5 (15 min)(as Aerosol)
Peak Limit	[ppm]	–	0.1 (15 min)	–	–
TLV-Value					
TWA	ppm = [mL/m ³]	25 (OSHA)	0.1	–	–
	[mg/m ³]	90 (OSHA)	0.7	–	–
STEL	ppm = [mL/m ³]	1	–	–	–
	[mg/m ³]	3.6	–	–	–
WEL-Value					
TWA	ppm = [mL/m ³]	[10]	0.1	–	–
	[mg/m ³]	[37]	0.68	–	–
STEL	ppm = [mL/m ³]	–	0.3	–	–
	[mg/m ³]	–	2.1	–	–
Conversion Factors					
1 ppm = 1 mL/m ³ = [mg/m ³]		3.68	6.82	–	–
[1 mg/m ³] = ppm = mL/m ³		0.27	0.15	–	–
Vapor Pressure at 20°C [h Pa]		239	32	0	–
Relative Vapor Density		3.06	–	–	–
Melting Point [°C]		-130	-64	198	635
Boiling Point [°C]		60	112	>250 Zers.	900
UN – Number		1991	1580	1463	1680
Group & Hazard Class		–	–	–	–
Ignition Temperature [°C]		440	–	–	–
Lower Ignition Limit [Vol%]		2.5	–	–	–
Upper Ignition Limit [Vol%]		20	–	–	–
Odor threshold (approx.) ppm		15	–	–	–

		Cyanogen chloride (as CN)	Cyclohexane	Cyclohexylamine	o-Dichlorobenzene
CAS – Number		[506-77-4]	[110-82-7]	[108-91-8]	[95-50-1]
Chemical Formula		C ₁ C ₁ N	C ₆ H ₁₂	C ₆ H ₁₁ NH ₂	C ₆ H ₄ Cl ₂
Molecular Weight [Kg/Kmol]		61.47	84.16	99.18	147.00
AGW-Value	ppm = [mL/m ³]	–	200	2	10
	[mg/m ³]	0.75	700	8.2	61
Peak Limit	[ppm]	–	800 (15 min)	4 (15 min)	20 (15 min)
TLV-Value					
TWA	ppm = [mL/m ³]	0.3	300	10	–
	[mg/m ³]	0.6	1050	40	–
STEL	ppm = [mL/m ³]	–	–	–	50
	[mg/m ³]	–	–	–	300
WEL-Value					
TWA	ppm = [mL/m ³]	–	100	10	25
	[mg/m ³]	–	340	41	153
STEL	ppm = [mL/m ³]	0.3	300	–	50
	[mg/m ³]	0.77	1050	–	306
Conversion Factors					
1 ppm = 1 mL/m ³ = [mg/m ³]		2.55	3.52	4.12	6.11
[1 mg/m ³] = ppm = mL/m ³		0.39	0.28	0.24	0.16
Vapor Pressure at 20°C [h Pa]		1336	104	13	1.3
Relative Vapor Density		212	2.91	3.42	5.07
Melting Point [°C]		-6.9	6	-17.7	-18
Boiling Point [°C]		13.0	81	134	179
UN – Number		1589	1145	2357	1591
Group & Hazard Class		–	A I	–	A III
Ignition Temperature [°C]		–	260	275	640
Lower Ignition Limit [Vol%]		–	1	1.14	1.7
Upper Ignition Limit [Vol%]		–	9.3	9.4	12
Odor threshold (approx.) ppm		1	0.4	–	2

		p-Dichlorobenzene	Dichlorodifluoromethane	1.3-Dichloropropen	Dichlorotetrafluoroethane
CAS – Number		[106-46-7]	[75-71-8]	[542-75-6]	[76-14-2]
Chemical Formula		C ₆ H ₄ Cl ₂	CF ₂ Cl ₂	HCCl=CH-CH ₂ Cl	F ₂ CIC-CF ₂ Cl
Molecular Weight [Kg/Kmol]		147.00	120.91	110.97	170.92
AGW-Value	ppm = [mL/m ³]	1	1000	–	1000
	[mg/m ³]	6	5000	–	7100
Peak Limit	[ppm]	1 (15 min)	2000 (15 min)	–	8000 (15 min)
TLV-Value					
TWA	ppm = [mL/m ³]	75 (OSHA)	1000	1	1000
	[mg/m ³]	450 (OSHA)	4950	5	7000
STEL	ppm = [mL/m ³]	–	–	–	–
	[mg/m ³]	–	–	–	–
WEL-Value					
TWA	ppm = [mL/m ³]	25	[1000]	–	1000
	[mg/m ³]	153	[5030]	–	7110
STEL	ppm = [mL/m ³]	50	[1250]	–	1250
	[mg/m ³]	306	[6280]	–	8890
Conversion Factors					
1 ppm = 1 mL/m ³ = [mg/m ³]		6.11	5.03	4.7	7.1
[1 mg/m ³] = ppm = mL/m ³		0.16	0.20	0.21	0.14
Vapor Pressure at 20°C	[h Pa]	1.7	5700	37	1824
Relative Vapor Density		1.248	4.18	3.83	6.11
Melting Point	[°C]	53	-158.2	-84	-94.2
Boiling Point	[°C]	174	-29.8	108	3.6
UN – Number		1592	1028	2047	1958
Group & Hazard Class		A III	–	A II	–
Ignition Temperature	[°C]	640	–	–	–
Lower Ignition Limit	[Vol%]	1.7	–	5.3	–
Upper Ignition Limit	[Vol%]	5.9	–	14.5	–
Odor threshold (approx.)	ppm	15	–	–	–

		Dichlorvos	Diethyl ether	Dimethyl acetamide	Dimethylformamide
CAS – Number		[62-73-7]	[60-29-7]	[127-19-5]	[68-12-2]
Chemical Formula		Cl ₂ C=CH-O-PO(OCH ₃) ₂	H ₃ C-CH ₂ -O-CH ₂ -CH ₃	H ₃ C-CO-N(CH ₃) ₂	HCO-N(CH ₃) ₂
Molecular Weight [Kg/Kmol]		220.98	74.12	87.12	73.09
AGW-Value	ppm = [mL/m ³]	0.11	400	10	5
	[mg/m ³]	1	1200	36	15
Peak Limit	[ppm]	0.22 (15 min)	400 (15 min)	20 (15 min)	10 (15 min)
TLV-Value					
TWA	ppm = [mL/m ³]	–	400 (OSHA)	10	10
	[mg/m ³]	1	1200 (OSHA)	35	30
STEL	ppm = [mL/m ³]	–	–	–	–
	[mg/m ³]	–	–	–	–
WEL-Value					
TWA	ppm = [mL/m ³]	[0.1]	100	10	10
	[mg/m ³]	[0.92]	310	36	30
STEL	ppm = [mL/m ³]	[0.3]	200	20	20
	[mg/m ³]	[2.8]	620	72	61
Conversion Factors					
1 ppm = 1 mL/m ³ = [mg/m ³]		9.81	3.08	3.62	3.04
[1 mg/m ³] = ppm = mL/m ³		0.11	0.33	0.28	0.33
Vapor Pressure at 20°C [h Pa]		0.016	586	3.3	3.77
Relative Vapor Density		7.63	2.56	3.01	2.52
Melting Point [°C]		<60	-116	-20	-61
Boiling Point [°C]		140	35	165	153
UN – Number		2810	1155	–	2265
Group & Hazard Class		–	A I	–	–
Ignition Temperature [°C]		–	175	490	440
Lower Ignition Limit [Vol%]		–	1.7	1.8	2.2
Upper Ignition Limit [Vol%]		–	39.2	11.5	16
Odor threshold (approx.) ppm		–	100	50	100

		Dimethyl sulfate	Dimethyl sulfide	Diphenylmethane diisocyanate	Epichlorohydrin
CAS – Number		[77-78-1]	[75-18-3]	[101-68-8]	[106-89-8]
Chemical Formula		(H ₃ CO) ₂ SO ₂	(CH ₃) ₂ S	(OCN-C ₆ H ₄) ₂ CH ₂	H ₂ C-O-CH-CH ₂ Cl
Molecular Weight [Kg/Kmol]		126.13	62.14	250.26	92.53
AGW-Value	ppm = [mL/m ³]	–	–	–	2 ¹⁾ 0.6 ²⁾
	[mg/m ³]	–	–	0.05 (as Aeroteol/15 min)	8 ¹⁾ 2.3 ²⁾
Peak Limit	[ppm]	–	–	0.05 (as Aeroteol/15 min)	4 ¹⁾ (15 min)
TLV-Value					
TWA	ppm = [mL/m ³]	0.1	–	0.005	5 (OSHA)
	[mg/m ³]	0.52	–	0.05	19 (OSHA)
STEL	ppm = [mL/m ³]	–	–	0.02 (10 min)	–
	[mg/m ³]	–	–	0.2 (10 min)	–
WEL-Value					
TWA	ppm = [mL/m ³]	0.05	–	–	0.5
	[mg/m ³]	0.26	–	–	1.9
STEL	ppm = [mL/m ³]	–	–	–	1.5
	[mg/m ³]	–	–	–	5.8
Conversion Factors					
1 ppm = 1 mL/m ³ = [mg/m ³]		5.24	2.58	10.40	3.85
[1 mg/m ³] = ppm = mL/m ³		0.19	0.39	0.096	0.26
Vapor Pressure at 20°C [h Pa]		0.35	527	0.0001	16
Relative Vapor Density		4.36	2.14	8.64	3.2
Melting Point [°C]		-32	-98.3	40	-48
Boiling Point [°C]		188.5 Zers.	37	196	116
UN – Number		1595	1164	2489	2023
Group & Hazard Class		A III	A I		A II
Ignition Temperature [°C]		450	215	520	385
Lower Ignition Limit [Vol%]		3.6	2.2	0.4	2.3
Upper Ignition Limit [Vol%]		23.2	19.7	–	34.4
Odor threshold (approx.) ppm		–	0.001	–	10

		Ethyl acetate	Ethylacrylat	Ethyl benzene	Ethyl chloroformate
CAS – Number		[141-78-6]	[140-88-5]	[100-41-4]	[541-41-3]
Chemical Formula		H ₃ C-COOCH ₂ -CH ₃	CH ₂ -CHCOOC ₂ H ₅	C ₆ H ₅ -CH ₂ -CH ₃	Cl-CO-O-CH ₂ -CH ₃
Molecular Weight [Kg/Kmol]		88.11	100.12	106.17	108.5
AGW-Value	ppm = [mL/m ³]	400	5	20	–
	[mg/m ³]	1500	21	88	–
Peak Limit	[ppm]	800 (15 min)	10 (15 min)	40 (15 min)	–
TLV-Value					
TWA	ppm = [mL/m ³]	400	25 (OSHA)	100	–
	[mg/m ³]	1400	100 (OSHA)	435	–
STEL	ppm = [mL/m ³]	–	–	125 (15 min)	–
	[mg/m ³]	–	–	545 (15 min)	–
WEL-Value					
TWA	ppm = [mL/m ³]	200	5	100	1
	[mg/m ³]	730	21	441	4.5
STEL	ppm = [mL/m ³]	400	15	125	–
	[mg/m ³]	1460	62	552	–
Conversion Factors					
1 ppm = 1 mL/m ³ = [mg/m ³]		3.66	4.15	4.41	4.52
[1 mg/m ³] = ppm = mL/m ³		0.27	0.24	0.23	0.22
Vapor Pressure at 20°C [h Pa]		98.4	39.1	9.79	54.6
Relative Vapor Density		3.04	3.45	3.66	3.74
Melting Point [°C]		-83	-75	-95.0	-80.6
Boiling Point [°C]		77	100	136	93
UN – Number		1173	1917	1175	1182
Group & Hazard Class		A I	A I	A I	500
Ignition Temperature [°C]		470	350	430	–
Lower Ignition Limit [Vol%]		2	1.7	1	3.7
Upper Ignition Limit [Vol%]		12.8	13	7.8	12.6
Odor threshold (approx.) ppm		50	–	25	–

		Ethylene	Ethylene dibromide	Ethylene glycol	Ethylene oxide
CAS – Number		[74-85-1]	[106-93-4]	[107-21-1]	[75-21-8]
Chemical Formula		H ₂ C-CH ₂	C ₂ HyBr ₂	H ₂ COHCH ₂ OH	H ₂ C-O-CH ₂
Molecular Weight [Kg/Kmol]		28.05	187.86	67.07	44.05
AGW-Value	ppm = [mL/m ³]	–	–	10 (as Aerosol)	1 ¹⁾ 0,1 ²⁾
	[mg/m ³]	–	–	26 (as Aerosol)	2 ¹⁾ 0,2 ²⁾
Peak Limit	[ppm]	–	–	20 (as Aerosol) (10 min)	2 ¹⁾ (15 min)
TLV-Value					
TWA	ppm = [mL/m ³]	–	0.045	–	0.1
	[mg/m ³]	–	–	–	0.18
STEL	ppm = [mL/m ³]	–	0.13 (15 min)	–	5 (10 min)
	[mg/m ³]	–	–	–	9 (10 min)
WEL-Value					
TWA	ppm = [mL/m ³]	–	3.9	20 (as Vapor)	5
	[mg/m ³]	–	–	52	9.2
STEL	ppm = [mL/m ³]	–	–	40	–
	[mg/m ³]	–	–	104	–
Conversion Factors		1.17			
1 ppm = 1 mL/m ³ = [mg/m ³]		0.86	7.80	2.58	1.83
[1 mg/m ³] = ppm = mL/m ³		–	0.13	0.39	0.55
Vapor Pressure at 20°C [h Pa]		0.97	11.3	0.053	1442
Relative Vapor Density		-169.2	6.49	2.14	1.56
Melting Point [°C]		-103	10	-16	-112.5
Boiling Point [°C]		1962	131	197	10.5
UN – Number		–	1605	–	1040
Group & Hazard Class		425	–	–	–
Ignition Temperature [°C]		2.4	–	410	435
Lower Ignition Limit [Vol%]		32.6	–	3.2	2.6
Upper Ignition Limit [Vol%]		–	–	43	100
Odor threshold (approx.) ppm		–	–	10	–

		Ethyl glycol acetate	Ethyl mercaptan	Fluorine	Formaldehyde
CAS – Number		[111-15-9]	[75-08-1]	[7782-41-4]	[50-00-0]
Chemical Formula		$C_2H_5OC_2H_4OCOCH_3$	H_3C-CH_2SH	F_2	HCHO
Molecular Weight [Kg/Kmol]		132.16	62.1	37.99	30.03
AGW-Value	ppm = [mL/m ³]	2	0.5	1	0.3 (DFG)
	[mg/m ³]	10.8	1.3	1.6	0.37 (DFG)
Peak Limit	[ppm]	16 (15 min)	1 (15 min)	2 (15 min)	0.6 (15 min)
TLV-Value					
TWA	ppm = [mL/m ³]	0.5	–	0.1	0.016
	[mg/m ³]	2.7	–	0.2	–
STEL	ppm = [mL/m ³]	–	0.5	–	0.1 (15 min)
	[mg/m ³]	–	1.3	–	–
WEL-Value					
TWA	ppm = [mL/m ³]	10	0.5	–	2
	[mg/m ³]	55	1.3	–	2.5
STEL	ppm = [mL/m ³]	–	2	1	2
	[mg/m ³]	–	5.2	1.6	2.5
Conversion Factors					
1 ppm = 1 mL/m ³ = [mg/m ³]		5.49	2.59	1.58	1.25
[1 mg/m ³] = ppm = mL/m ³		0.18	0.39	0.63	0.80
Vapor Pressure at 20°C [h Pa]		2.67	576	–	–
Relative Vapor Density		4.56	2.14	1.3	1.04
Melting Point [°C]		-61.7	-147.9	-219.6	-117
Boiling Point [°C]		156	35	-188.1	-19
UN – Number		1172	2363	1045	–
Group & Hazard Class		A II	A I	–	–
Ignition Temperature [°C]		380	395	–	430
Lower Ignition Limit [Vol%]		1.2	2.8	–	7
Upper Ignition Limit [Vol%]		10.7	18	–	73
Odor threshold (approx.) ppm		–	0.001	–	< 1

		Formic Acid	n-Hexane	Hexamethylene diisocyanate	Hydrazine
CAS – Number		[64-18-6]	[110-54-3]	[822-06-0]	[302-01-2]
Chemical Formula		HCOOH	H ₃ C-(CH ₂) ₄ -CH ₃	OCN-(CH ₂) ₆ -NCO	H ₂ N-NH ₂
Molecular Weight [Kg/Kmol]		46.03	86.18	168.20	32.05
AGW-Value	ppm = [mL/m ³]	5	50	0.005 (as Aerosol)	0.017 ¹⁾ 0.0017 ²⁾
	[mg/m ³]	9.5	180	0.035 (as Aerosol)	0.022 ¹⁾ 0.0022 ²⁾
Peak Limit	[ppm]	10 (15 min)	400 (15 min)	0.005 (as Aerosol) (15 min)	0.034 ¹⁾ (15 min)
TLV-Value					
TWA	ppm = [mL/m ³]	5	50	–	1 (OSHA)
	[mg/m ³]	9	180	0.035	1.3 (OSHA)
STEL	ppm = [mL/m ³]	–	–	–	0.03 (120 min)
	[mg/m ³]	–	–	0.14 (10 min)	0.04 (120 min)
WEL-Value					
TWA	ppm = [mL/m ³]	5	20	–	0.02
	[mg/m ³]	9.6	72	–	0.03
STEL	ppm = [mL/m ³]	–	–	–	0.1
	[mg/m ³]	–	–	–	0.13
Conversion Factors					
1 ppm = 1 mL/m ³ = [mg/m ³]		1.91	3.58	6.99	1.33
[1 mg/m ³] = ppm = mL/m ³		0.52	0.28	0.14	0.75
Vapor Pressure at 20°C [h Pa]		44.6	160	0.014	21
Relative Vapor Density		1.59	2.98	1.00	1.05
Melting Point [°C]		8	-95.3	-67	1.54
Boiling Point [°C]		101	68.7	255	113.5
UN – Number		1779	1208	2281	2029
Group & Hazard Class		–	A I	–	–
Ignition Temperature [°C]		520	230	400	270
Lower Ignition Limit [Vol%]		10	1.0	0.9	4.7
Upper Ignition Limit [Vol%]		45.5	8.9	9.5	100
Odor threshold (approx.) ppm		20	–	–	3

		Hydrochloric acid	Hydrocyanic Acid	Hydrogen	Hydrogen fluoride
CAS – Number		[7647-01-0]	[74-90-8]	[1333-74-0]	[7664-39-3]
Chemical Formula		HCl	HCN	H ₂	HF
Molecular Weight [Kg/Kmol]		36.46	27.03	2.02	20.01
AGW-Value	ppm = [mL/m ³]	2	1.9 (DFG)	–	1
	[mg/m ³]	3	2.1 (DFG)	–	0.83
Peak Limit	[ppm]	4 (15 min)	3.8 (DFG)	–	2 (15 min)
TLV-Value					
TWA	ppm = [mL/m ³]	–	10 (OSHA)	–	3
	[mg/m ³]	–	11 (OSHA)	–	2.5
STEL	ppm = [mL/m ³]	5 (15 min)	4.7	–	6 (15 min)
	[mg/m ³]	7 (15 min)	5	–	5 (15 min)
WEL-Value					
TWA	ppm = [mL/m ³]	–	–	–	1.8
	[mg/m ³]	–	–	–	1.5
STEL	ppm = [mL/m ³]	–	10	–	3
	[mg/m ³]	–	11	–	2.5
Conversion Factors					
1 ppm = 1 mL/m ³ = [mg/m ³]		1.52	1.12	0.084	0.83
[1 mg/m ³] = ppm = mL/m ³		0.66	0.89	11.90	1.20
Vapor Pressure at 20°C [h Pa]		42560	817	–	1000
Relative Vapor Density		1.27	0.93	0.07	0.69
Melting Point [°C]		-114.8	-13	-259.1	-83.6
Boiling Point [°C]		-85.1	26	-252.8	19.5
UN – Number		1050	1051	1049	1052
Group & Hazard Class		–	–	–	–
Ignition Temperature [°C]		–	535	560	–
Lower Ignition Limit [Vol%]		–	5.5	4	4.75
Upper Ignition Limit [Vol%]		–	46.6	75.6	–
Odor threshold (approx.) ppm		–	2	odorless	–

		Hydrogen peroxide	Hydrogen sulfide	Iodine	Mercury vapor
CAS – Number		[7722-84-1]	[7783-06-4]	[7553-56-2]	[7439-97-6]
Chemical Formula		H ₂ O ₂	H ₂ S	I ₂	Hg
Molecular Weight [Kg/Kmol]		34.01	34.08	253.80	200.59
AGW-Value	ppm = [mL/m ³]	0.5 (DFG)	5	–	–
	[mg/m ³]	0.71 (DFG)	7.1	–	0.02
Peak Limit	[ppm]	0.5	10 (15 min)	–	0,16 (15 min)
TLV-Value					
TWA	ppm = [mL/m ³]	1	–	–	–
	[mg/m ³]	1.4	–	–	–
STEL	ppm = [mL/m ³]	–	10 (10 min)	0.1	–
	[mg/m ³]	–	15 (15 min)	1	0.1
WEL-Value					
TWA	ppm = [mL/m ³]	1	5	–	–
	[mg/m ³]	1.4	7	–	[0.025]
STEL	ppm = [mL/m ³]	2	10	0.1	–
	[mg/m ³]	2.8	14	1.1	–
Conversion Factors					
1 ppm = 1 mL/m ³ = [mg/m ³]		1.41	1.42	10.52	8.34
[1 mg/m ³] = ppm = mL/m ³		0.71	0.71	0.095	0.12
Vapor Pressure at 20°C [h Pa]		1.9	18190	0.28	0.0013
Relative Vapor Density		1.17	1.19	8.8	6.93
Melting Point [°C]		-0.4	-85.7	114	-38.8
Boiling Point [°C]		150.2	-60.2	185.24	356.72
UN – Number		2015	1053	3495	2809
Group & Hazard Class		–	–	–	–
Ignition Temperature [°C]		–	270	–	–
Lower Ignition Limit [Vol%]		–	4.3	–	–
Upper Ignition Limit [Vol%]		–	45.5	–	–
Odor threshold (approx.) ppm		–	< 0.1	–	odorless

		Methacrylonitrile	Methane	Methanol	Methyl acrylate
CAS – Number		[126-98-7]	[74-82-8]	[67-56-1]	[96-33-3]
Chemical Formula		H ₂ C=C(CH ₃)CN	CH ₄	H ₃ COH	H ₂ C=CH-COOCH ₃
Molecular Weight [Kg/Kmol]		67.09	16.04	32.04	86.09
AGW-Value	ppm = [mL/m ³]	–	–	200	5
	[mg/m ³]	–	–	270	18
Peak Limit	[ppm]	–	–	800 (15 min)	5 (15 min)
TLV-Value					
TWA	ppm = [mL/m ³]	1	–	200	10
	[mg/m ³]	3	–	260	35
STEL	ppm = [mL/m ³]	–	–	250 (15 min)	–
	[mg/m ³]	–	–	325 (15 min)	–
WEL-Value					
TWA	ppm = [mL/m ³]	1	–	200	[10]
	[mg/m ³]	2.8	–	260	[36]
STEL	ppm = [mL/m ³]	–	–	250	–
	[mg/m ³]	–	–	333	–
Conversion Factors					
1 ppm = 1 mL/m ³ = [mg/m ³]		2.79	0.67	1.33	3.58
[1 mg/m ³] = ppm = mL/m ³		0.36	1.50	0.75	0.28
Vapor Pressure at 20°C [h Pa]		86	–	128.6	91.1
Relative Vapor Density		2.32	0.55	1.11	2.97
Melting Point [°C]		-36	-182.47	-97.9	-75
Boiling Point [°C]		90	-161.5	65	80
UN – Number		1992	1971/1972	1230	1919
Group & Hazard Class		A I	–	B	A I
Ignition Temperature [°C]		465	595	440	415
Lower Ignition Limit [Vol%]		1.7	4.4	6	1.95
Upper Ignition Limit [Vol%]		13.2	17	50	16.3
Odor threshold (approx.) ppm		–	–	5	0.1

		Methyl bromide	Methyl chloroformate	Methylene chloride	Methyl ethyl ketone
CAS – Number		[74-83-9]	[79-22-1]	[75-09-2]	[78-93-3]
Chemical Formula		CH ₃ Br	Cl-CO-O-CH ₃	CH ₂ Cl ₂	CH ₃ -CH ₂ -CO-CH ₃
Molecular Weight [Kg/Kmol]		94.94	94.45	84.93	72.2
AGW-Value	ppm = [mL/m ³]	1	0.2	75	200
	[mg/m ³]	3.9	0.78	260	600
Peak Limit	[ppm]	2 (15 min)	0.4 (15 min)	300 (15 min)	300
TLV-Value					
TWA	ppm = [mL/m ³]	–	–	25 (OSHA)	200
	[mg/m ³]	–	–	–	590
STEL	ppm = [mL/m ³]	20 (OSHA)	–	125 (OSHA)	300 (15 min)
	[mg/m ³]	80 (OSHA)	–	–	885 (15 min)
WEL-Value					
TWA	ppm = [mL/m ³]	5	–	100	200
	[mg/m ³]	20	–	350	600
STEL	ppm = [mL/m ³]	15	–	300	300
	[mg/m ³]	59	–	1060	899
Conversion Factors					
1 ppm = 1 mL/m ³ = [mg/m ³]		3.95	3.93	3.47	3.0
[1 mg/m ³] = ppm = mL/m ³		0.25	0.26	0.28	0.33
Vapor Pressure at 20°C [h Pa]		1890	127	470	105
Relative Vapor Density		3.36	3.26	2.93	2.48
Melting Point [°C]		-93.7	-61	-96.7	-86
Boiling Point [°C]		4	71.4	40	80
UN – Number		1062	1238	1593	1193
Group & Hazard Class		–	–	–	A 1
Ignition Temperature [°C]		535	504	605	505
Lower Ignition Limit [Vol%]		8.6	10.6	13	1.5
Upper Ignition Limit [Vol%]		20	–	22	12.6
Odor threshold (approx.) ppm		odorless	–	180	< 25

		Methyl isobutyl ketone	Methylisothiocyanate (MITC)	Methyl mercaptan	Methyl methacrylate
CAS – Number		[108-10-1]	[556-61-6]	[74-93-1]	[80-62-6]
Chemical Formula		(H ₃ C) ₂ C ₂ H ₃ -CO-CH ₃	H ₃ C-N=C=S	H ₃ C ₂ SH	H ₂ C=C(CH ₃)COOCH ₃
Molecular Weight [Kg/Kmol]		100.16	73.11	48.1	100.12
AGW-Value	ppm = [mL/m ³]	20	–	0.5	50
	[mg/m ³]	83	–	1	210
Peak Limit	[ppm]	40 (15 min)	–	1 (15 min)	100 (15 min)
TLV-Value					
TWA	ppm = [mL/m ³]	50	–	–	100
	[mg/m ³]	205	–	–	410
STEL	ppm = [mL/m ³]	75 (15 min)	–	0.5 (15 min)	–
	[mg/m ³]	300 (15 min)	–	1 (15 min)	–
WEL-Value					
TWA	ppm = [mL/m ³]	50	–	0.5	50
	[mg/m ³]	208	–	1	208
STEL	ppm = [mL/m ³]	100	–	–	100
	[mg/m ³]	416	–	–	416
Conversion Factors					
1 ppm = 1 mL/m ³ = [mg/m ³]		4.16	3.04	2.0	4.16
[1 mg/m ³] = ppm = mL/m ³		0.24	0.33	0.5	0.24
Vapor Pressure at 20°C [h Pa]		18.8	26	1700	39.6
Relative Vapor Density		3.46	2.53	1.7	3.46
Melting Point [°C]		-80.3	35	-123	-48.2
Boiling Point [°C]		115.9	119	6	101
UN – Number		1245	2477	1064	1247
Group & Hazard Class		A I	–	–	A I
Ignition Temperature [°C]		475	–	360	430
Lower Ignition Limit [Vol%]		1.2	–	4.1	1.7
Upper Ignition Limit [Vol%]		8	–	21	12.5
Odor threshold (approx.) ppm		0.5	–	0.002	20

		MTBE	Nickel tetracarbonyl	Nitric acid	Nitrogen dioxide
CAS – Number		[1634-04-4]	[13463-39-3]	[7697-37-2]	[10102-44-0]
Chemical Formula		C ₅ H ₁₂ O	Ni(CO) ₄	HNO ₃	NO ₂
Molecular Weight [Kg/Kmol]		88.15	170.73	63.01	46.01
AGW-Value	ppm = [mL/m ³]	50	–	–	0.5 (DFG)
	[mg/m ³]	180	–	–	0.95 (DFG)
Peak Limit	[ppm]	75 (15 min)	–	1 (15 min)	0.5 (15 min)
TLV-Value					
TWA	ppm = [mL/m ³]	–	0.001	2	–
	[mg/m ³]	–	0.007	5	–
STEL	ppm = [mL/m ³]	–	–	4 (15 min)	1 (15 min)
	[mg/m ³]	–	–	10 (15 min)	1.8 (15 min)
WEL-Value					
TWA	ppm = [mL/m ³]	25	–	–	[3]
	[mg/m ³]	92	–	–	[5.7]
STEL	ppm = [mL/m ³]	75	0,1 (als Ni)	1	5
	[mg/m ³]	275	0,24 (als Ni)	2.6	9.6
Conversion Factors					
1 ppm = 1 mL/m ³ = [mg/m ³]		3.66	7.10	2.62	1.91
[1 mg/m ³] = ppm = mL/m ³		0.27	0.14	0.38	0.52
Vapor Pressure at 20°C [h Pa]		268	425	60	963
Relative Vapor Density		–	5.9	2.18	2.62
Melting Point [°C]		-109	-25	-41.6	-11.3
Boiling Point [°C]		55	43	121.8	21.1
UN – Number		2398	1259	2032	1067
Group & Hazard Class		–	A I	–	–
Ignition Temperature [°C]		435	35	–	–
Lower Ignition Limit [Vol%]		1.6	0.9	–	–
Upper Ignition Limit [Vol%]		8.4	–	–	–
Odor threshold (approx.) ppm		–	0.2	–	0.5

		Nitroglycol	n-Octane	Oil mist	Oxygen
CAS – Number		[628-96-6]	[111-65-9]	–	[7782-44-7]
Chemical Formula		O ₂ N-O-(CH ₂) ₂ -O-NO ₂	C ₈ H ₁₈	mixture	O ₂
Molecular Weight [Kg/Kmol]		152.06	114.23	–	32.00
AGW-Value	ppm = [mL/m ³]	0.05 (as Aerosol)	500	–	–
	[mg/m ³]	0.322 (as Aerosol)	2400	–	–
Peak Limit	[ppm]	0.05 (as Aerosol) (15 min)	1000 (15 min)	–	–
TLV-Value					
TWA	ppm = [mL/m ³]	–	75	–	–
	[mg/m ³]	–	350	5	–
STEL	ppm = [mL/m ³]	–	385 (15 min)	–	–
	[mg/m ³]	0.1 (15 min)	1800 (15 min)	10	–
WEL-Value					
TWA	ppm = [mL/m ³]	[0.2]	210	–	–
	[mg/m ³]	[1.3]	1200	–	–
STEL	ppm = [mL/m ³]	[0.2]	–	–	–
	[mg/m ³]	[1.3]	–	–	–
Conversion Factors					
1 ppm = 1 mL/m ³ = [mg/m ³]		6.32	4.75	–	1.33
[1 mg/m ³] = ppm = mL/m ³		0.16	0.21	–	0.75
Vapor Pressure at 20°C [h Pa]		0.053	14	–	–
Relative Vapor Density		5.25	3.95	–	1.10
Melting Point [°C]		-22.3	-57	liq.	-219
Boiling Point [°C]		197.5	126	–	-183.0
UN – Number		–	1262	–	1072
Group & Hazard Class		–	A I	–	–
Ignition Temperature [°C]		217	205	–	–
Lower Ignition Limit [Vol%]		–	0.8	–	–
Upper Ignition Limit [Vol%]		–	6.5	–	–
Odor threshold (approx.) ppm		–	–	–	odorless

		Ozone	n-Pentane	Perchloroethylene	Phenol
CAS – Number		[10028-15-6]	[109-66-0]	[127-18-4]	[108-95-2]
Chemical Formula		O ₃	H ₃ C-(CH ₂) ₃ -CH ₃	Cl ₂ C=CCl ₂	C ₆ H ₅ OH
Molecular Weight [Kg/Kmol]		48.00	72.15	165.83	94.11
AGW-Value	ppm = [mL/m ³]	–	1000	20	2 (as Aerosol)
	[mg/m ³]	–	3000	138	8 (as Aerosol)
Peak Limit	[ppm]	–	2000 (15 min)	40 (15 min)	4 (as Aerosol) (15 min)
TLV-Value					
TWA	ppm = [mL/m ³]	0.1 (OSHA)	120	100 (OSHA)	5
	[mg/m ³]	0.2 (OSHA)	350	–	19
STEL	ppm = [mL/m ³]	0.1	610 (15 min)	200 (OSHA)	15.6 (15 min)
	[mg/m ³]	0.2	1800 (15 min)	–	60 (15 min)
WEL-Value					
TWA	ppm = [mL/m ³]	–	600	50	2
	[mg/m ³]	–	1800	345	–
STEL	ppm = [mL/m ³]	0.2	–	100	–
	[mg/m ³]	0.4	–	689	–
Conversion Factors					
1 ppm = 1 mL/m ³ = [mg/m ³]		2.00	3.00	6.89	3.91
[1 mg/m ³] = ppm = mL/m ³		0.50	0.33	0.15	0.26
Vapor Pressure at 20°C [h Pa]		–	562	19.4	0.2
Relative Vapor Density		1.66	2.49	5.73	3.25
Melting Point [°C]		-192.5	-129.7	-22	41
Boiling Point [°C]		-111.9	36	121	182
UN – Number		–	1265	1897	1671
Group & Hazard Class		–	A I	–	A III
Ignition Temperature [°C]		–	260	>650	595
Lower Ignition Limit [Vol%]		–	1.4	–	1.3
Upper Ignition Limit [Vol%]		–	7.8	–	9.5
Odor threshold (approx.) ppm		0.015	–	20	0.05

		Phosgene	Phosphine	Propane	iso-Propanol
CAS – Number		[75-44-5]	[7803-51-2]	[74-98-6]	[67-63-0]
Chemical Formula		COCl ₂	PH ₃	H ₃ C-CH ₂ -CH ₃	(H ₃ C) ₂ -CHOH
Molecular Weight [Kg/Kmol]		98.92	34.00	44.1	60.1
AGW-Value	ppm = [mL/m ³]	0.1	0.1	1000	200
	[mg/m ³]	0.41	0.14	1800	500
Peak Limit	[ppm]	0.2 (15 min)	0.1 (15 min)	4000 (15 min)	400 (15 min)
TLV-Value		0.1			
TWA	ppm = [mL/m ³]	0.4	0.3	1000	400
	[mg/m ³]	0.2 (15 min)	0.4	1800	980
STEL	ppm = [mL/m ³]	0.8 (15 min)	1 (15 min)	–	500 (15 min)
	[mg/m ³]		1.0 (15 min)	–	1225 (15 min)
WEL-Value		0.02			
TWA	ppm = [mL/m ³]	0.08	0.1	–	400
	[mg/m ³]	0.06	0.14	–	999
STEL	ppm = [mL/m ³]	0.25	0.2	–	500
	[mg/m ³]		0.28	–	1250
Conversion Factors					
1 ppm = 1 mL/m ³ = [mg/m ³]		4.11	1.41	1.83	2.5
[1 mg/m ³] = ppm = mL/m ³		0.24	0.71	0.55	0.4
Vapor Pressure at 20°C [h Pa]		1564	34880	8237	42.6
Relative Vapor Density		3.5	1.18	1.55	2.07
Melting Point [°C]		-127.8	-133.8	-187.7	-88
Boiling Point [°C]		7.44	-87.8	-42.1	82
UN – Number		1076	2199	1978	1219
Group & Hazard Class		–	–	–	–
Ignition Temperature [°C]		–	100	470	425
Lower Ignition Limit [Vol%]		–	1.6	1.7	2
Upper Ignition Limit [Vol%]		–	100	10.8	13.4
Odor threshold (approx.) ppm		0.5	0.02	–	1000

		Propylene	Pyridine	Sodium cyanide	Sulphur dioxide
CAS – Number		[115-07-1]	[110-86-1]	[143-33-9]	[7446-09-5]
Chemical Formula		H ₂ C=CH-CH ₃	C ₅ H ₅ N	NaCN	SO ₂
Molecular Weight [Kg/Kmol]		42.1	79.10	49.0	64.06
AGW-Value	ppm = [mL/m ³]	–	–	–	1
	[mg/m ³]	–	–	3.8 (as Aerosol)(DFG)	2.5
Peak Limit	[ppm]	–	–	3.8 (as Aerosol) (DFG)	1 (15 min)
TLV-Value					
TWA	ppm = [mL/m ³]	–	5	–	2
	[mg/m ³]	–	15	–	5
STEL	ppm = [mL/m ³]	–	–	–	5 (15 min)
	[mg/m ³]	–	–	–	10 (15 min)
WEL-Value					
TWA	ppm = [mL/m ³]	–	5	–	[2]
	[mg/m ³]	–	16	–	[5.3]
STEL	ppm = [mL/m ³]	–	10	–	[5]
	[mg/m ³]	–	33	–	[13]
Conversion Factors					
1 ppm = 1 mL/m ³ = [mg/m ³]		1.76	3.29	–	2.66
[1 mg/m ³] = ppm = mL/m ³		0.57	0.31	–	0.37
Vapor Pressure at 20°C [h Pa]		10140	50.5	–	3305
Relative Vapor Density		1.48	2.73	–	2.26
Melting Point [°C]		-185.3	-42	563	-75.5
Boiling Point [°C]		-47.7	115	1497	-10.1
UN – Number		1077	1282	1689	1079
Group & Hazard Class		–	B	–	–
Ignition Temperature [°C]		485	550	–	–
Lower Ignition Limit [Vol%]		1.8	1.7	–	–
Upper Ignition Limit [Vol%]		11.2	10.6	–	–
Odor threshold (approx.) ppm		–	ab 30 ppm intolerable	–	0.5

		Sulfuric acid	Sulfurylfluorid	Styrene	1.1.1.2-Tetrafluoroethan
CAS – Number		[7664-93-9]	[2699-79-8]	[100-42-5]	[811-97-2]
Chemical Formula		H ₂ SO ₄	SO ₂ F ₂	CH ₂ =CH-CH ₂	F ₃ C-CH ₂ F
Molecular Weight [Kg/Kmol]		98.08	102.06	104.15	102.03
AGW-Value	ppm = [mL/m ³]	–	–	20	1000
	[mg/m ³]	0.1 (as Aerosol)	10	86	4200
Peak Limit	[ppm]	0.1 (as Aerosol) (15 min)	–	40 (15 min)	8000 (15 min)
TLV-Value					
TWA	ppm = [mL/m ³]	–	5	50	–
	[mg/m ³]	1	20	215	–
STEL	ppm = [mL/m ³]	–	10 (15 min)	100 (15 min)	–
	[mg/m ³]	–	40 (15 min)	425 (15 min)	–
WEL-Value					
TWA	ppm = [mL/m ³]	–	5	100	1000
	[mg/m ³]	[1]	21	430	4240
STEL	ppm = [mL/m ³]	–	10	250	–
	[mg/m ³]	–	42	1080	–
Conversion Factors					
1 ppm = 1 mL/m ³ = [mg/m ³]		–	4.23	4.33	4.25
[1 mg/m ³] = ppm = mL/m ³		–	0.24	0.23	0.33
Vapor Pressure at 20°C [h Pa]		<0.001	15500	7.14	6620
Relative Vapor Density		3.4	3.58	3.6	3.53
Melting Point [°C]		10	-135.8	-31	–
Boiling Point [°C]		335	-55.4	145	-26.5
UN – Number		1830	2191	2055	1078
Group & Hazard Class		–	–	A II	–
Ignition Temperature [°C]		–	–	490	–
Lower Ignition Limit [Vol%]		–	–	0.97	–
Upper Ignition Limit [Vol%]		–	–	7.7	–
Odor threshold (approx.) ppm		–	–	0.1	–

		Tetrahydrothiophene	Tet.-Butyl-mercaptan	Toluene	2,4-Toluene diisocyanate
CAS – Number		[110-01-0]	[75-66-1]	[108-88-3]	[584-84-9]
Chemical Formula		$\text{CH}_2\text{-C}_3\text{H}_6\text{-S}$	$\text{C}_4\text{H}_{10}\text{S}$	$\text{C}_6\text{H}_5\text{-CH}_3$	$\text{H}_3\text{C-C}_6\text{H}_3(\text{NCO})_2$
Molecular Weight [Kg/Kmol]		88.17	90.19	92.14	174.16
AGW-Value	ppm = [mL/m ³]	50	–	50	0.005 (as Aerosol) (15 min)
	[mg/m ³]	180	–	190	0.035 (as Aerosol) (15 min)
Peak Limit	[ppm]	50 (15 min)	–	200 (15 min)	0.005 (as Aerosol) (15 min)
TLV-Value					
TWA	ppm = [mL/m ³]	–	–	100	–
	[mg/m ³]	–	–	375	–
STEL	ppm = [mL/m ³]	–	–	150 (15 min)	0.02 (OSHA)
	[mg/m ³]	–	–	560 (15 min)	0.14 (OSHA)
WEL-Value					
TWA	ppm = [mL/m ³]	–	–	50	–
	[mg/m ³]	–	–	191	–
STEL	ppm = [mL/m ³]	–	–	100	–
	[mg/m ³]	–	–	384	–
Conversion Factors					
1 ppm = 1 mL/m ³ = [mg/m ³]		3.66	3.74	3.83	7.24
[1 mg/m ³] = ppm = mL/m ³		0.27	0.27	0.26	0.14
Vapor Pressure at 20°C [h Pa]		19	24.1	29.1	0.03
Relative Vapor Density		3.04	3.11	3.18	6.02
Melting Point [°C]		-96.2	1	-95.0	21
Boiling Point [°C]		121	64	111	251
UN – Number		2412	2347	1294	2078
Group & Hazard Class		A I	–	A I	–
Ignition Temperature [°C]		200	253 °C	535	620
Lower Ignition Limit [Vol%]		1.1	1.3	1	0.9
Upper Ignition Limit [Vol%]		12.3	8.7	7.8	9.5
Odor threshold (approx.) ppm		–	–	< 5	–

		2.6-Toluene diisocyanate	o-Toluidine	1.1.1-Trichloroethane	1.1.2-Trichloroethane
CAS – Number		[91-08-7]	[95-53-4]	[71-55-6]	[79-00-5]
Chemical Formula		H ₃ C-C ₆ H ₃ (NCO) ₂	H ₃ C-C ₆ H ₄ -NH ₂	H ₃ C-CCl ₃	ClCH ₂ -CHCl ₂
Molecular Weight [Kg/Kmol]		174.16	107.16	133.40	133.4
AGW-Value	ppm = [mL/m ³]	0.005 (as Aerosol)	–	200	10
	[mg/m ³]	0.035 (as Aerosol)	–	1100	55
Peak Limit	[ppm]	0.005 (as Aerosol) (15 min)	–	200 (15 min)	20 (15 min)
TLV-Value					
TWA	ppm = [mL/m ³]	–	5 (OSHA)	350 (OSHA)	10
	[mg/m ³]	–	22 (OSHA)	1900 (OSHA)	45
STEL	ppm = [mL/m ³]	0.02 (OSHA)	–	350 (15 min)	–
	[mg/m ³]	0.14 (OSHA)	–	1910 (15 min)	–
WEL-Value					
TWA	ppm = [mL/m ³]	–	0.2	200	10
	[mg/m ³]	–	0.89	200	45
STEL	ppm = [mL/m ³]	–	–	200	–
	[mg/m ³]	–	–	2220	–
Conversion Factors					
1 ppm = 1 mL/m ³ = [mg/m ³]		7.24	4.45	5.54	5.54
[1 mg/m ³] = ppm = mL/m ³		0.14	0.23	0.18	0.18
Vapor Pressure at 20°C [h Pa]		0.02	0.18	133	25
Relative Vapor Density		6.02	3.7	4.61	4.61
Melting Point [°C]		18.3	-16.3	-30	-35.5
Boiling Point [°C]		129	200	-74	113.7
UN – Number		2078	1708	2831	–
Group & Hazard Class		–	A III	–	–
Ignition Temperature [°C]		–	480	490	460
Lower Ignition Limit [Vol%]		9.0	1.5	8	8.4
Upper Ignition Limit [Vol%]		–	7.5	15.5	13.3
Odor threshold (approx.) ppm		–	0.5	< 100	–

		Trichloroethylene	Triethylamine	Trichlorotrifluoroethane	Trichlorofluoromethane
CAS – Number		[79-01-6]	[121-44-8]	[76-13-1]	[75-69-4]
Chemical Formula		ClHC=CCl ₂	(H ₃ C-CH ₂) ₃ N	F ₂ CIC-CFCl ₂	CFCl ₃
Molecular Weight [Kg/Kmol]		131.39	101.19	187.38	137.37
AGW-Value	ppm = [mL/m ³]	11 ¹⁾ 6 ²⁾	1	500	1000
	[mg/m ³]	60 ¹⁾ 33 ²⁾	4.2	3900	5700
Peak Limit	[ppm]	88 ¹⁾ (15 min)	2 (15 min)	1000 (15 min)	2000 (15 min)
TLV-Value					
TWA	ppm = [mL/m ³]	25	25 (OSHA)	1000	1000 (OSHA)
	[mg/m ³]	–	100 (OSHA)	7600	5600 (OSHA)
STEL	ppm = [mL/m ³]	2 (1h)	–	1250 (15 min)	1000
	[mg/m ³]	–	–	9500 (15 min)	5600
WEL-Value					
TWA	ppm = [mL/m ³]	100	2	[1000]	[1000]
	[mg/m ³]	550	8	[7790]	[5710]
STEL	ppm = [mL/m ³]	150	4	[1250]	[1250]
	[mg/m ³]	820	17	[9740]	[7140]
Conversion Factors					
1 ppm = 1 mL/m ³ = [mg/m ³]		5.46	4.21	7.79	5.71
[1 mg/m ³] = ppm = mL/m ³		0.18	0.24	0.13	0.18
Vapor Pressure at 20°C [h Pa]		77.6	69.6	364	0.886
Relative Vapor Density		4.53	3.5	6.47	4.75
Melting Point [°C]		-73	-114.7	-35	-111
Boiling Point [°C]		87	89	47.6	23.6
UN – Number		1710	1296	–	–
Group & Hazard Class		–	B	–	–
Ignition Temperature [°C]		410	215	680	–
Lower Ignition Limit [Vol%]		7.9	1.2	–	–
Upper Ignition Limit [Vol%]		100	8.0	–	–
Odor threshold (approx.) ppm		20	–	–	–

		Vinyl chloride	Water vapor	Xylene
CAS – Number		[75-01-4]	[7732-18-5]	[1330-20-7]
Chemical Formula		H ₂ C=CHCl	H ₂ O	C ₆ H ₄ (CH ₃) ₂
Molecular Weight [Kg/Kmol]		62.50	18.02	106.17
AGW-Value	ppm = [mL/m ³]	3	–	100
	[mg/m ³]	7.7	–	440
Peak Limit	[ppm]	–	–	200 (15 min)
TLV-Value				
TWA	ppm = [mL/m ³]	1 (OSHA)	–	100
	[mg/m ³]	–	–	435
STEL	ppm = [mL/m ³]	5 (OSHA)	–	150 (15 min)
	[mg/m ³]	–	–	655 (15 min)
WEL-Value				
TWA	ppm = [mL/m ³]	3	–	50
	[mg/m ³]	–	–	220
STEL	ppm = [mL/m ³]	–	–	100
	[mg/m ³]	–	–	441
Conversion Factors				
1 ppm = 1 mL/m ³ = [mg/m ³]		2.6	0.75	4.41
[1 mg/m ³] = ppm = mL/m ³		0.38	1.33	0.23
Vapor Pressure at 20°C [h Pa]		3.343	23	–
Relative Vapor Density		2.16	0.631	3.67
Melting Point [°C]		-153.7	0	-5... 13
Boiling Point [°C]		-13.4	100	136... 140
UN – Number		1086	–	1307
Group & Hazard Class		–	–	A II
Ignition Temperature [°C]		415	–	465
Lower Ignition Limit [Vol%]		3.8	–	1.7
Upper Ignition Limit [Vol%]		31	–	7.6
Odor threshold (approx.) ppm		–	–	4

6. Directory of Synonyms

The first column is an alphabetical list of chemical names, trade names and synonyms. When a synonym or trade name is given the appropriate Dräger-Tube or Dräger Chip is listed in the second column with brackets.

Chemical name / Trade name / Synonym	Dräger-Tube / Dräger Chip
Acetaldehyde	[Acetaldehyde]
Acetan	[Ethylene]
Acetene	[Ethylene]
Acetic Acid	[Acetic Acid]
Acetic Acid of Ethyl Ester	[Ethyl Acetate]
Acetic Aldehyde	[Acetaldehyde]
Acetic Ester	[Ethyl Acetate]
Acetic Ether	[Ethyl Acetate]
Acetone	[Acetone]
Acetoxyethane	[Ethyl Acetate]
Acid	[Acid Test]
Acryl Acid of Methyl Ester	[Methyl Acrylate]
Acrylonitrile	[Acrylonitrile]
Acrylonitrile Monomer	[Acrylonitrile]
Alcohol	[Alcohol]
Alcohol Spirits	[Alcohol]
Aldehyde	[Acetaldehyde]
alpha-Trichloroethane	[Trichloroethane]
Amine	[Amine Test]
Aminobenzene	[Aniline]
Aminocyclohexane	[Cyclohexylamine]
Ammonia	[Ammonia]
Ammonium Hydrate	[Ammonia]
Ammonium Hydroxide	[Ammonia]
Anhydrous Ammonia	[Ammonia]
Aniline	[Aniline]
Aniline Oil	[Aniline]
Aqua Ammonia	[Ammonia]
Aqua Fortis	[Nitric Acid]
Aqueous Ammonia	[Ammonia]
Arsenic Hydride	[Arsine]
Arsenic Trihydride	[Arsine]
Arsenious Hydride	[Arsine]
Arsine	[Arsine]
Benzenamine	[Aniline]

Chemical name / Trade name / Synonym	Dräger-Tube / Dräger Chip
Benzene	[Benzene]
Benzene Chloride	[Chlorobenzene]
Benzol	[Benzene]
Benzolphenol	[Phenol]
beta-Chlorobutadiene	[Chloroprene]
Biethylene	[Butadiene]
Bivinyll	[Butadiene]
Bromotrifluoromethane	[Halogenated Hydrocarbons]
Bromomethane	[Methyl Bromide]
BTX	[Benzene]
BTX	[Toluene]
BTX	[Xylene]
Buta-1,3-diene	[Butadiene]
1,3-Butadiene	[Butadiene]
1-Butanethiol	[Tertiary Butylmercaptan]
Butanethiol	[Tertiary Butylmercaptan]
Butyl Mercaptan	[Mercaptan]
Butylene	[Olefine]
Carbinol	[Alcohol]
Carbolic Acid	[Phenol]
Carbon Bisulfide	[Carbon Disulfide]
Carbon Dioxide	[Carbon Dioxide]
Carbon Disulfide	[Carbon Disulfide]
Carbon Monoxide	[Carbon Monoxide]
Carbon Oxide	[Carbon Monoxide]
Carbon Oxychloride	[Phosgene]
Carbon Sulfide	[Carbon Disulfide]
Carbon Tetrachloride	[Carbon Tetrachloride]
Carbonic Acid Gas	[Carbon Dioxide]
Carbonic Anhydride	[Carbon Dioxide]
Carbonic Oxide	[Carbon Monoxide]
Carbonyl Chloride	[Phosgene]
Cecolene 1	[Trichloroethylene]
Cecolene 2	[Perchloroethylene]
Cellosolve Acetate	[Ethyl Glycol Acetate]
CFC	[Halogenated Hydrocarbons]
1-Chlore-2,3-epoxypropane	[Vinyl Chloride]
Chlorine	[Chlorine]

Chemical name / Trade name / Synonym	Dräger-Tube / Dräger Chip
---	---------------------------

Chlorine Cyanide	[Cyanogen Chloride]
Chlorine Dioxide	[Chlorine Dioxide]
2-Chloro-1,3-butadiene	[Chloroprene]
Chlorobenzene	[Chlorobenzene]
Chlorobenzol	[Chlorobenzene]
Chloroethene	[Vinyl Chloride]
Chloroform	[Chloroform]
Chloroformyl Chloride	[Phosgene]
Chloroformates	[Chloroformates]
Chlorohydric Acid	[Hydrochloric Acid]
Chloropicrine	[Chloropicrine]
Chloroprene	[Chloroprene]
2-Chloropropylene Oxide	[Epichlorohydrin]
Chloropropylene Oxide	[Epichlorohydrin]
Chromic Acid	[Chromic Acid]
Cinnamene	[Styrene]
Creosote Oil	[Phenol]
Cyanide	[Cyanide]
Cyanogen Chloride	[Cyanogen Chloride]
Cyclohexane	[Cyclohexane]
Cyclohexylamine	[Cyclohexylamine]
DDVP	[Phosphoric Acid Esters]
Desmodur H	[Isocyanate Sampling Set]
Desmodur T	[Toluene Diisocyanate]
Di-henylmethane-4,4'-diisocyanate	[Isocyanate Sampling Set]
Dialkylsulfide	[Thioether]
Diamine	[Hydrazine]
Dichloromethane	[Methylene Chloride]
1,3-Dichloropropene	Vinyl Chloride
Dichloropropene	Vinyl Chloride
Dichlorvos	[Phosphoric Acid Esters]
Diethyl Ether	[Diethyl Ether]
Diethyl Oxide	[Diethyl Ether]
Diethylaminoethane	[Triethylamine]
Difluorochlorobromomethane	[Halogenated Hydrocarbons]
Difluorochloromethane	[Halogenated Hydrocarbons]
Difluorodichloromethane	[Halogenated Hydrocarbons]
Dihydroxirene	[Ethylene Oxide]

Chemical name / Trade name / Synonym	Dräger-Tube / Dräger Chip
1,2-Dihydroxyethane	[Ethylene Glycol]
2,4-Diisocyanato-1-methylbenzene	[Toluene Diisocyanate]
2,6-Diisocyanato-1-methylbenzene	[Toluene Diisocyanate]
4,4-Diisocyanatodiphenylmethane	[Isocyanate Sampling Set]
Dimethyl Dichlorovinyl Phosphate	[Phosphoric Acid Esters]
Dimethyl Ester of Sulfuric Acid	[Dimethyl Sulfate]
Dimethyl Formamide	[Dimethyl Formamide]
Dimethyl Sulfate	[Dimethyl Sulfate]
Dimethyl Sulfide	[Dimethyl Sulfide]
Dimethylbenzene	[Xylene]
Dimethylene Oxide	[Ethylene Oxide]
Dimethylketone	[Acetone]
Dimethylmethane	[Propane]
Dinitrogen Tetroxide	[Nitrogen Dioxide]
4,4-Diphenylmethane Diisocyanate	[Isocyanate Sampling Set]
DMF	[Dimethyl Formamide]
Dow-Per	[Perchloroethylene]
Elayl	[Ethylene]
EO	[Ethylene Oxide]
Epichlorohydrin	[Epichlorohydrin]
1,2-Epoxyethane	[Ethylene Oxide]
Erythrene	[Butadiene]
Ethanal	[Acetaldehyde]
1,2-Ethanediol	[Ethylene Glycol]
Ethanoic Acid	[Acetic Acid]
Ethanol	[Alcohol]
Ethene	[Ethylene]
Ether	[Diethyl Ether]
2-Ethoxyethyl Acetate	[Ethyl Glycol Acetate]
Ethyl Acetate	[Ethyl Acetate]
Ethyl Acetic Ester	[Ethyl Acetate]
Ethyl Alcohol	[Alcohol]
Ethyl Aldehyde	[Acetaldehyde]
Ethyl Benzene	[Ethyl Benzene]
Ethyl Chlorcarbonate	[Chloroformates]
Ethyl Chloroformate	[Chloroformates]
Ethyl Ester of Acetic Acid	[Ethyl Acetate]
Ethyl Ether	[Diethyl Ether]

Chemical name / Trade name / Synonym	Dräger-Tube / Dräger Chip
---	---------------------------

Ethyl Formate	[Ethyl Formate]
Ethyl Glycol Acetate	[Ethyl Glycol Acetate]
Ethyl Mercaptan	[Mercaptan]
Ethyl Oxide	[Diethyl Ether]
Ethylene	[Ethylene]
Ethylene Alcohol	[Ethylene Glycol]
Ethylene Glycol	[Ethylene Glycol]
Ethylene Glycol Monoethyl Ether Acetate	[Ethyl Glycol Acetate]
Ethylene Oxide	[Ethylene Oxide]
Ethylene Tetrachloride	[Perchloroethylene]
Ethylene Trichloride	[Trichloroethylene]
Ethylic Acid	[Acetic Acid]
F 113	[Halogenated Hydrocarbons]
F 114	[Halogenated Hydrocarbons]
F 12	[Halogenated Hydrocarbons]
F 12 B 1	[Halogenated Hydrocarbons]
F 13 B 1	[Halogenated Hydrocarbons]
F 22	[Halogenated Hydrocarbons]
F 11	[Halogenated Hydrocarbons]
Fluorine	[Fluorine]
Fluorotrichloromethane	[Halogenated Hydrocarbons]
Formaldehyde	[Formaldehyde]
Formalin	[Formaldehyde]
Formic Acid	[Formic Acid]
Formic Aldehyde	[Formaldehyde]
Formonitrile	[Hydrocyanic Acid]
Formyl Trichloride	[Chloroform]
Formylic Acid	[Formic Acid]
Freon	[Halogenated Hydrocarbons]
Genklene	[Trichloroethane]
Glacial Acetic Acid	[Acetic Acid]
Glycol	[Ethylene Glycol]
Glysantin	[Ethylene Glycol]
Halogenated Hydrocarbons	[Halogenated Hydrocarbons]
Halon 1211	[Halogenated Hydrocarbons]
Halon 1301	[Halogenated Hydrocarbons]
HDI	[Isocyanate Sampling Set]
Hexahydroaniline	[Cyclohexylamine]

Chemical name / Trade name / Synonym	Dräger-Tube / Dräger Chip
Hexahydrobenzene	[Cyclohexane]
Hexamethylene	[Cyclohexane]
Hexamethylene Diisocyanate	[Isocyanate Sampling Set]
Hexanaphthene	[Cyclohexane]
Hydrazine	[Hydrazine]
Hydrazine Base	[Hydrazine]
Hydrazine, Anhydrous	[Hydrazine]
Hydrocarbons	[Hydrocarbons]
Hydrochloric Acid	[Hydrochloric Acid]
Hydrocyanic Acid	[Hydrochloric Acid]
Hydrogen	[Hydrogen]
Hydrogen Carboxylic Acid	[Formic Acid]
Hydrogen Chloride	[Hydrochloric Acid]
Hydrogen Cyanide	[Hydrocyanic Acid]
Hydrogen Fluoride	[Hydrogen Fluoride]
Hydrogen Nitrate	[Nitric Acid]
Hydrogen Peroxide	[Hydrogen Peroxide]
Hydrogen Phosphide	[Phosphine]
Hydrogen Sulfate	[Sulfuric Acid]
Hydrogen Sulfide	[Hydrogen Sulfide]
Hydroperoxide	[Hydrogen Peroxide]
Hydrosulfuric Acid	[Hydrogen Sulfide]
Iod	[Iodine]
Iodine	[Iodine]
i-Prapanol	[i-Prapanol]
i-Propanol	[Alcohol]
iso-Propanol	[Alcohol]
iso-Propanol	[i-Prapanol]
Isopropanol	[Alcohol]
Isopropanol	[i-Prapanol]
Ketone Propane	[Acetone]
Krystallin	[Aniline]
Kyanol	[Aniline]
March Gas	[Natural Gas]
MD1	[Isocyanate Sampling Set]
MEG	[Ethylene Glycol]
Mercaptan	[Mercaptan]
Mercury Vapor	[Mercury Vapor]

Chemical name / Trade name / Synonym	Dräger-Tube / Dräger Chip
Methanal	[Formaldehyde]
Methane	[Natural Gas]
Methane Trichloride	[Chloroform]
Methanecarboxylic Acid	[Acetic Acid]
Methanoic Acid	[Formic Acid]
Methanol	[Alcohol]
Methenyl Trichloride	[Chloroform]
Methyl Acrylate	[Methyl Acrylate]
Methyl Alcohol	[Alcohol]
Methyl Bromide	[Methyl Bromide]
Methyl Chlorocarbonate	[Chloroformates]
Methyl Chloroform	[Trichloroethane]
Methyl Chloroformate	[Chloroformates]
Methyl Ester of Acrylic Acid	[Methyl Acrylate]
Methyl Hydroxide	[Alcohol]
Methyl Ketone	[Acetone]
Methyl Mercaptan	[Mercaptan]
Methyl Sulfate	[Dimethyl Sulfate]
Methyl Sulfide	[Dimethyl Sulfide]
Methyl Trichloride	[Chloroform]
Methylbenzene	[Toluene]
Methylene Bisphenyl Isocyanate	[Isocyanate Sampling Set]
Methylene Chloride	[Methylene Chloride]
Methylene Dichloride	[Methylene Chloride]
4,4-Methylenediphenyl Diisocyanate	[Isocyanate Sampling Set]
Methylisothiocyanate	[Methylisothiocyanate]
Methyltrichloromethane	[Trichloroethane]
MITC	[Methylisothiocyanate]
Monobromomethane	[Methyl Bromide]
Monochlorobenzene	[Chlorobenzene]
Monochloroethylene	[Vinyl Chloride]
Monoethylene Glycol	[Ethylene Glycol]
Monohydroxy Benzene	[Phenol]
Monohydroxymethane	[Alcohol]
Mononitrogen Monoxide	[Nitrous Fumes]
Mononitrotrichloromethane	[Chloropicrine]
Monostyrene	[Styrene]
MTBE	[MTBE]

Chemical name / Trade name / Synonym	Dräger-Tube / Dräger Chip
m-Xylene	[Xylene]
Natural Gas	[Natural Gas]
n-Butanol	[Alcohol]
N-Formyldimethylamine	[Dimethyl Formamide]
n-Hexane	[Hexane]
Nickel Carbonyl	[Nickel Tetracarbonyl]
Nickel Tetracarbonyl	[Nickel Tetracarbonyl]
Nitric Acid	[Nitric Acid]
Nitric Oxide	[Nitrous Fumes]
Nitrogen (II) Oxide	[Nitrous Fumes]
Nitrogen Dioxide	[Nitrogen Dioxide]
Nitrogen Peroxide	[Nitrogen Dioxide]
Nitrous Fumes	[Nitrous Fumes]
Normal-Hexane	[Hexane]
Nox	[Nitrous Furnes]
n-Pentane	[Pentane]
Oil	[Oil]
Oil Mist	[Oil Mist]
Oil of Vitriol	[Sulfuric Acid]
Olefine	[Olefine]
Organic Arsenic Compounds	[Organic Arsenic Compounds]
Organic Basic Nitrogen Compounds	[Organic Basic Nitrogen Compounds]
o-Toluidine	[Toluidine]
Oxirane	[Ethylene Oxide]
Oxybenzene	[Phenol]
Oxygen	[Oxygen]
o-Xylene	[Xylene]
Oxymethylene	[Formaldehyde]
Ozone	[Ozone]
Paraformaldehyde	[Formaldehyde]
Perchloroethylene	[Perchloroethylene]
Perchlorornethane	[Carbon Tetrachloridel]
Perclene	[Perchloroethylene]
Perhydrol	[Hydrogen Peroxide]
Perk	[Perchloroethylene]
Perone	[Hydrogen Peroxide]
Petroleum Hydrocarbons	[Petroleum Hydrocarbons]
Phenol	[Phenol]

Chemical name / Trade name / Synonym	Dräger-Tube / Dräger Chip
---	---------------------------

Phenol Alcohol	[Phenol]
Phenyl Chloride	[Chlorobenzene]
Phenyl Hydride	[Benzene]
Phenyl Hydroxide	[Phenol]
Phenylamine	[Aniline]
Phenylethane	[Ethyl Benzene]
Phenylethene	[Styrene]
Phenylethylene	[Styrene]
Phenylic Acid	[Phenol]
Phenylmethane	[Toluene]
Phosgene	[Phosgene]
Phosphanes	[Phosphine]
Phosphine	[Phosphine]
Phosphoric Acid Esters	[Phosphoric Acid Esters]
Phosphorus Hydride	[Phosphine]
Phosphorus Trihydride	[Phosphine]
Propan-2-ol	[Alcohol]
Propan-2-ol	[i-Prapanol]
Propane	[Propane]
2-Propanol	[Alcohol]
2-Propanol	[i-Prapanol]
2-Propanone	[Acetone]
Propanone-2	[Acetone]
Propenenitrile	[Acrylonitrile]
Propyl Mercaptan	[Mercaptan]
Propylene	[Olefine]
Propylhydride	[Propane]
Proxyllic Spirit	[Alcohol]
Prussic Acid	[Hydrocyanic Acid]
p-Xylene	[Xylene]
Pyrene	[Carbon Tetrachloride]
Pyridine	[Pyridine]
Pyroacetic Ether	[Acetone]
Pyrrolylene	[Butadiene]
R 11	[Halogenated Hydrocarbons]
R 113	[Halogenated Hydrocarbons]
R 114	[Halogenated Hydrocarbons]
R 12	[Halogenated Hydrocarbons]

Chemical name / Trade name / Synonym	Dräger-Tube / Dräger Chip
R 12 B 1	[Halogenated Hydrocarbons]
R 13 B 1	[Halogenated Hydrocarbons]
R 22	[Halogenated Hydrocarbons]
Retinaphtha	[Toluene]
Solvent Ether	[Diethyl Ether]
Styrene Monomer	[Styrene]
Sulfuric Acid	[Sulfuric Acid]
Sulfur Dioxide	[Sulfur Dioxide]
Sulfur Oxide	[Sulfur Dioxide]
Sulfuric Ether	[Diethyl Ether]
Sulfurous Acid Anhydride	[Sulfur Dioxide]
Sulfureted Hydrogen	[Hydrogen Sulfide]
Sulfuryl Fluoride	[Sulfuryl Fluoride]
TDI	[Toluene Diisocyanate]
TEA	[Triethylamine]
Tert. Butylmercaptan	[Tertiary Butylmercaptan]
Tert. Butylmethylether	[MTBE]
Tertiary Butylmercaptan	[Tertiary Butylmercaptan]
Tetrachloroethene	[Perchloroethylene]
Tetrachloroethylene	[Perchloroethylene]
Tetrachloromethane	[Carbon Tetrachloride]
Tetraform	[Carbon Tetrachloride]
Tetrahydrothiophene	[Tetrahydrothiophene]
1,1,2,2,-Tetrafluoro-1,2-dichloroethane	[Halogenated Hydrocarbons]
Thioether	[Thioether]
Thiophane	[Tetrahydrothiophene]
THT	[Tetrahydrothiophene]
Toluene	[Toluene]
2,4-Toluene Diisocyanate	[Toluene Diisocyanate]
2,6-Toluene Diisocyanate	[Toluene Diisocyanate]
Toluene Diisocyanate	[Toluene Diisocyanate]
Toluene-2,4-diisocyanate	[Toluene Diisocyanate]
Toluene-2,6-diisocyanate	[Toluene Diisocyanate]
2,4-Tolylene Diisocyanate	[Toluene Diisocyanate]
2,6-Tolylene Diisocyanate	[Toluene Diisocyanate]
Tri	[Trichloroethylene]
1,1,1-Trichloroethane	[Trichloroethane]
Trichloroethane	[Trichloroethane]

Chemical name / Trade name / Synonym	Dräger-Tube / Dräger Chip
Trichloroethene	[Trichloroethylene]
Trichloroethylene	[Trichloroethylene]
Trichlorofluoromethane	[Halogenated Hydrocarbons]
Trichloromethane	[Chloroform]
Trichloronitromethane	[Chloropicrine]
Triclene	[Trichloroethylene]
Trielene	[Trichloroethylene]
Triethylamine	[Triethylamine]
1,1,2-Trifluoro-1,2,2-trichloroethane	[Halogenated Hydrocarbons]
Trioxane	[Formaldehyde]
V inegar Naphtha	[Ethyl Acetate]
Vinyl Chloride	[Vinyl Chloride]
Vinyl Cyanide	[Acrylonitrile]
Vinyl Ethylene	[Butadiene]
Vinylbenzene	[Styrene]
Vinylbenzol	[Styrene]
W ater Vapor	[Water Vapor]
Wood Alcohol	[Alcohol]
X ylene	[Xylene]
Xylol	[Xylene]

CORPORATE HEADQUARTERS

Drägerwerk AG & Co. KGaA
Moislinger Allee 53–55
23558 Lübeck, Germany

www.draeger.com

Manufacturer:

Dräger Safety AG & Co. KGaA
Revalstraße 1
23560 Lübeck, Germany

REGION EUROPE CENTRAL AND EUROPE NORTH

Dräger Safety AG & Co. KGaA
Revalstraße 1
23560 Lübeck, Germany
Tel +49 451 882 0
Fax +49 451 882 2080
info@draeger.com

REGION EUROPE SOUTH

Dräger Safety France SAS
25, rue Georges Besse
92182 Antony Cedex
Tel +33 1 46 11 56 00
Fax +33 1 40 96 97 20
europe.south@draeger.com

REGION MIDDLE EAST, AFRICA

Dräger Safety AG & Co. KGaA
Branch Office
P.O. Box 505108
Dubai, United Arab Emirates
Tel +971 4 4294 600
Fax +971 4 4294 699
contactuae@draeger.com

REGION ASIA PACIFIC

Dräger Safety Asia Pte Ltd
25 International Business Park
#04-20/21 German Centre
Singapore 609916
Tel +65 6308 9400
Fax +65 6308 9401
asia.pacific@draeger.com

REGION CENTRAL AND SOUTH AMERICA

Dräger Panama S. de R.L.
Complejo Business Park,
V tower, 10th floor
Panama City
Tel +507 377-9100
Fax +507 377-9130
contactosa@draeger.com

Locate your Regional Sales
Representative at:
www.draeger.com/contact

